

# TI-Nspire™ CX Student Software Guidebook

## ***Important Information***

Except as otherwise expressly stated in the Licence that accompanies a programme, Texas Instruments makes no warranty, either express or implied, including but not limited to any implied warranties of merchantability and fitness for a particular purpose, regarding any programmes or book materials and makes such materials available solely on an "as-is" basis. In no event shall Texas Instruments be liable to anyone for special, collateral, incidental or consequential damages in connection with or arising out of the purchase or use of these materials, and the sole and exclusive liability of Texas Instruments, regardless of the form of action, shall not exceed the amount set forth in the licence for the programme. Moreover, Texas Instruments shall not be liable for any claim of any kind whatsoever against the use of these materials by any other party.

© 2023 Texas Instruments Incorporated

Adobe®, Excel®, Mac®, Microsoft®, PowerPoint®, Vernier DataQuest™, Vernier EasyLink®, Vernier EasyTemp®, Vernier Go!Link®, Vernier Go!Motion®, Vernier Go!Temp®, Windows®, and Windows® XP are trademarks of their respective owners.

Actual products may vary slightly from provided images.

## Contents

<b>Getting Started with TI-Nspire™ CX Student Software</b> .....	<b>1</b>
Selecting the Handheld Type .....	1
Exploring the Documents Workspace .....	2
Changing Language .....	3
Using Software Menu Shortcuts .....	4
Using Handheld Keyboard Shortcuts .....	7
<b>Using the Documents Workspace</b> .....	<b>13</b>
Exploring the Documents Workspace .....	13
Using the Documents Toolbox .....	13
Exploring Document Tools .....	14
Exploring the Page Sorter .....	14
Exploring the TI-SmartView™ Feature .....	15
Exploring Content Explorer .....	17
Exploring Utilities .....	18
Using the Work Area .....	19
Changing Document Settings .....	20
Changing Graphs & Geometry Settings .....	22
<b>Working with Connected Handhelds</b> .....	<b>24</b>
Managing Files on a Connected Handheld .....	24
Checking for an OS Update .....	26
Installing an OS Update .....	27
<b>Working with TI-Nspire™ Documents</b> .....	<b>31</b>
Creating a New TI-Nspire™ Document .....	31
Opening an Existing Document .....	32
Saving TI-Nspire™ Documents .....	33
Deleting Documents .....	34
Closing Documents .....	34
Formatting Text in Documents .....	35
Using Colours in Documents .....	36
Setting Page Size and Document Preview .....	36
Working with Multiple Documents .....	37
Working with Applications .....	38
Selecting and Moving Pages .....	41
Working with Problems and Pages .....	44
Printing Documents .....	46
Viewing Document Properties and Copyright Information .....	47
<b>Working with Lesson Bundles</b> .....	<b>49</b>
Creating a New Lesson Bundle .....	49
Adding Files to a Lesson Bundle .....	50
Opening a Lesson Bundle .....	52
Managing Files in a Lesson Bundle .....	52

Managing Lesson Bundles .....	54
Packaging Lesson Bundles .....	56
Emailing a Lesson Bundle .....	57
Sending Lesson Bundles to Connected Handhelds .....	57
<b>Capturing Screens .....</b>	<b>59</b>
Accessing Screen Capture .....	59
Using Capture Page .....	59
Using Capture Selected Handheld .....	60
Viewing Captured Screens .....	61
Saving Captured Pages and Screens .....	62
Copying and Pasting a Screen .....	64
Capturing Images in Handheld Mode .....	64
<b>Working with Images .....</b>	<b>67</b>
Working with Images in the Software .....	67
<b>Responding to Questions .....</b>	<b>70</b>
Understanding the Question Toolbar .....	70
Types of Questions .....	70
Responding to Quick Poll Questions .....	71
Submitting Responses .....	73
<b>Calculator Application .....</b>	<b>74</b>
Entering and Evaluating Maths Expressions .....	75
CAS: Working with Measurement Units .....	82
Using the Unit Conversion Assistant .....	84
Working with Variables .....	86
Creating User-defined Functions and Programmes .....	87
Editing Calculator Expressions .....	91
Financial Calculations .....	92
Working with the Calculator History .....	93
<b>Using Variables .....</b>	<b>97</b>
Linking Values on Pages .....	97
Creating Variables .....	97
Using (Linking) Variables .....	102
Naming Variables .....	104
Adjusting Variable Values with a Slider .....	105
Locking and Unlocking Variables .....	107
Removing a Linked Variable .....	109
<b>Graphs Application .....</b>	<b>111</b>
What You Must Know .....	112
Graphing Functions .....	114
Exploring Graphs with Path Plot .....	115
Manipulating Functions by Dragging .....	116

Specifying a Function with Domain Restrictions .....	118
Finding Points of Interest on a Function Graph .....	119
Graphing a Family of Functions .....	121
Graphing Equations .....	122
Graphing Conic Sections .....	123
Graphing Relations .....	126
Graphing Parametric Equations .....	129
Graphing Polar Equations .....	129
Graphing Scatter Plots .....	130
Plotting Sequences .....	131
Graphing Differential Equations .....	133
Viewing Tables from the Graphs Application .....	136
Editing Relations .....	137
Accessing the Graph History .....	138
Zooming/Rescaling the Graphs Work Area .....	139
Customising the Graphs Work Area .....	141
Hiding and Showing Items in the Graphs Application .....	144
Conditional Attributes .....	145
Calculating a Bounded Area .....	146
Tracing Graphs or Plots .....	148
Introduction to Geometric Objects .....	150
Creating Points and Lines .....	152
Creating Geometric Shapes .....	157
Creating Shapes Using Gestures (MathDraw) .....	163
Basics of Working with Objects .....	165
Measuring Objects .....	169
Transforming Objects .....	174
Exploring with Geometric Construction Tools .....	177
Animating Points on Objects .....	182
Adjusting Variable Values with a Slider .....	183
Labelling (Identifying) the Coordinates of a Point .....	185
Displaying the Equation of a Geometric Object .....	186
Using the Calculate Tool .....	187
<b>3D Graphs .....</b>	<b>189</b>
Graphing 3D Functions .....	189
Graphing 3D Parametric Equations .....	190
Rotating the 3D View .....	191
Editing a 3D Graph .....	192
Accessing the Graph History .....	192
Changing the Appearance of a 3D Graph .....	193
Showing and Hiding 3D Graphs .....	194
Customising the 3D Viewing Environment .....	194
Tracing in the 3D View .....	196
Example: Creating an Animated 3D Graph .....	197
<b>Geometry Application .....</b>	<b>199</b>
What You Must Know .....	199

Introduction to Geometric Objects .....	202
Creating Points and Lines .....	204
Creating Geometric Shapes .....	209
Creating Shapes Using Gestures (MathDraw) .....	215
Basics of Working with Objects .....	217
Measuring Objects .....	221
Transforming Objects .....	226
Exploring with Geometric Construction Tools .....	229
Using Geometry Trace .....	234
Conditional Attributes .....	235
Hiding Objects in the Geometry Application .....	236
Customizing the Geometry Work Area .....	237
Animating Points on Objects .....	238
Adjusting Variable Values with a Slider .....	239
Using the Calculate Tool .....	241
<b>Lists &amp; Spreadsheet Application .....</b>	<b>244</b>
Creating and Sharing Spreadsheet Data as Lists .....	245
Creating Spreadsheet Data .....	247
Navigating in a Spreadsheet .....	250
Working with Cells .....	251
Working with Rows and Columns of Data .....	255
Sorting Data .....	258
Generating Columns of Data .....	259
Graphing Spreadsheet Data .....	262
Exchanging Data with Other Computer Software .....	266
Capturing Data from Graphs & Geometry .....	269
Using Table Data for Statistical Analysis .....	274
Statistics Input Descriptions .....	274
Statistical Calculations .....	276
Distributions .....	280
Confidence Intervals .....	286
Stat Tests .....	288
Working with Function Tables .....	292
<b>Data &amp; Statistics Application .....</b>	<b>295</b>
Basic Operations in Data & Statistics .....	296
Overview of Raw and Summary Data .....	300
Working with Numeric Plot Types .....	301
Working with Categorical Plot Types .....	310
Exploring Data .....	318
Using Window/Zoom Tools .....	327
Graphing Functions .....	328
Using Graph Trace .....	333
Customising Your Workspace .....	334
Adjusting Variable Values with a Slider .....	335
Inferential Statistics .....	338

<b>Notes Application</b> .....	<b>340</b>
Using Templates in Notes .....	341
Formatting Text in Notes .....	342
Using Colour in Notes .....	343
Inserting Images .....	344
Inserting Items on a Notes Page .....	344
Inserting Comments .....	345
Inserting Geometric Shape Symbols .....	345
Entering Maths Expressions in Notes Text .....	346
Evaluating and Approximating Maths Expressions .....	347
Using Maths Actions .....	349
Graphing from Notes and Calculator .....	352
Inserting Chemical Equations in Notes .....	353
Deactivating Maths Expression Boxes .....	354
Changing the Attributes of Maths Expression Boxes .....	355
Using Calculations in Notes .....	356
Exploring Notes with Examples .....	357
<b>Data Collection</b> .....	<b>362</b>
What You Must Know .....	363
About Collection Devices .....	364
Connecting Sensors .....	368
Setting Up an Offline Sensor .....	369
Modifying Sensor Settings .....	370
Collecting Data .....	372
Using Data Markers to Annotate Data .....	376
Collecting Data Using a Remote Collection Unit .....	378
Setting Up the Sensor for Triggering .....	380
Collecting and Managing Data Sets .....	382
Using Sensor Data in Programmes .....	385
Collecting Sensor Data using RefreshProbeVars .....	386
Analysing Collected Data .....	387
Displaying Collected Data in Graph View .....	393
Displaying Collected Data in Table View .....	394
Customising the Graph of Collected Data .....	399
Striking and Restoring Data .....	408
Replaying the Data Collection .....	408
Adjusting Derivative Settings .....	410
Drawing a Predictive Plot .....	411
Using Motion Match .....	412
Printing Collected Data .....	412
<b>Widgets</b> .....	<b>415</b>
Creating a Widget .....	415
Adding a Widget .....	415
Saving a Widget .....	418

<b>Libraries</b>	<b>419</b>
What is a Library?	419
Creating Libraries and Library Objects	419
Private and Public Library Objects	420
Using Library Objects	421
Creating Shortcuts to Library Objects	422
Included Libraries	422
Restoring an Included Library	423
<b>Using the TI-SmartView™ Emulator</b>	<b>424</b>
Opening the TI-SmartView™ Emulator	424
Choosing Display Options	425
Working with the Emulated Handheld	426
Using the Touchpad	427
Using Settings and Status	427
Changing TI-SmartView™ Options	428
Working with Documents	429
Using Screen Capture	429
<b>Using the Help Menu</b>	<b>430</b>
Activating Your Software Licence	430
Registering Your Product	432
Downloading the Latest Guidebook	432
Exploring TI Resources	432
Updating the TI-Nspire™ Software	433
Updating the OS on a Connected Handheld	433
Viewing Software Version and Legal Information	434
Helping Improve the Product	435
<b>Using Test Mode</b>	<b>436</b>
Entering Test Mode by Choosing Restrictions	436
Entering Test Mode with a Test Code	438
Reviewing Test Mode Restrictions	441
Working with a Document in Test Mode	442
Exiting Test Mode	444
Understanding Test Mode Restrictions	444
<b>Appendix A: Conversion Categories and Units</b>	<b>448</b>
<b>General Information</b>	<b>452</b>
<b>Index</b>	<b>453</b>



# Getting Started with TI-Nspire™ CX Student Software

TI-Nspire™ CX Student Software enables students to use PC and Mac® computers to perform the same functions as on a handheld. This document covers:

- TI-Nspire™ CX Student Software
- TI-Nspire™ CX CAS Student Software

**Note:** When there are differences between the software, those differences are described.

## Selecting the Handheld Type

When you launch the software for the first time, you will see the Handheld Type selection dialog box:

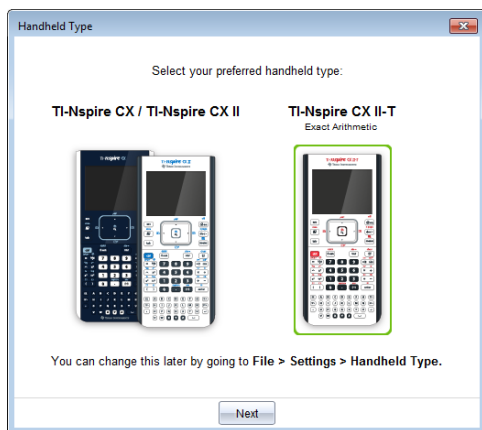

Click the image of the handheld type you want to use then click **Next** to apply that selection and open the software.

To change the handheld type after the first launch:

1. Click **File > Settings > Handheld Type** and select the type you want.

The Handheld Type confirmation dialog box opens.

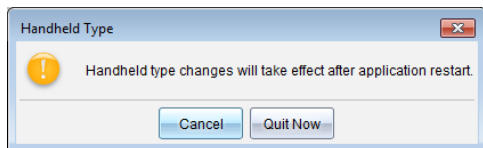

2. Click **Cancel** to continue your work.

—or—

Click **Quit Now** to close the software immediately. You will be prompted to save any open documents. When you restart the software, the new handheld type will be applied.

## Exploring the Documents Workspace

Use the menu options and toolbar options in the workspace to create or edit TI-Nspire™ documents and work with applications and problems. The tools in the workspace are specific to working with open documents.

**Note:** Although not labeled, the Documents Workspace is the default workspace in the TI-Nspire™ CX Student Software. Throughout the documentation and help, the area where you work with documents is referred to as the Documents Workspace.

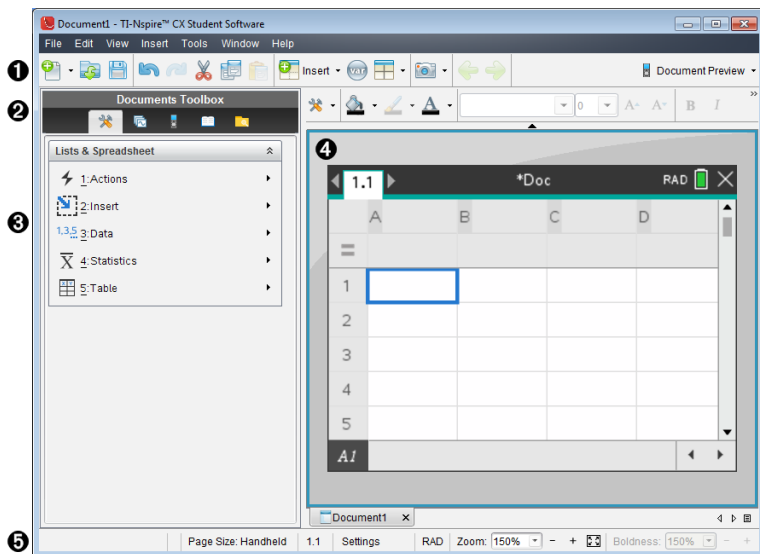

- 1 Toolbar.** Contains short-cuts to frequently performed tasks such as creating new documents, opening existing documents, saving documents, inserting applications, inserting variables and taking screen captures. The cut, copy and paste icons are also located in the toolbar. At the right side, a **Document Preview** button lets you select Handheld or Computer preview.
- 2 Documents Toolbox.** Contains tools needed to work with TI-Nspire™ documents. Use these tools to open the application menus, use the page sorter to view TI-Nspire™ documents, open the TI-SmartView™ emulator, open Content Explorer, insert utilities such as maths templates and the symbols from the catalogue.
- 3 Toolbox pane.** Options for the selected tool are displayed in this area. For example, click the Document Tools icon to access tools needed to work with the active application.
- 4 Work area.** Shows the current page of the active (selected) document. Lets you perform calculations, add applications and add problems and pages. Only one

document at a time is active. Multiple documents appear as tabs.

- 5 **Status bar.** Provides information about the active document.

## Understanding the Status Bar

The status bar provides information about the current document, and provides options that enable you to toggle between Handheld and Computer view and adjust how the document appears in the work area.

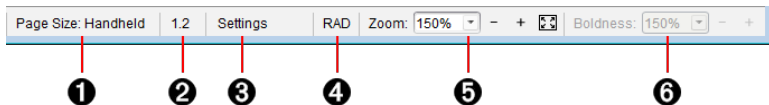

- 1 **Page Size.** Shows the document's page size as Handheld or Computer. You can use the TI-Nspire™ **File** menu to convert a document from one page size to the other.
- 2 **Problem/Page counter.** The first value represents the problem number of the active page, and the second value tells you the page number within the problem. In the example, the counter reads **1.2**, indicating Problem 1, Page 2.
- 3 **Settings.** Double-click to view or change the Document Settings for the active document or to change the default Document Settings.
- 4 **Mode.** Shows the angle mode (RAD, DEG, GRAD) for the current page of the document, or for the active Math Box in a Notes application.
- 5 **Zoom.** Enabled in Handheld preview only (click **Document Preview** on the toolbar and select **Handheld**). Click ▼ and select a magnification value for the preview.
- 6 **Boldness.** Enabled in Computer preview only (click **Document Preview** on the toolbar and select **Computer**). Click ▼ and select a value to increase or decrease the boldness of text and other items.

## Changing Language

Use this option to select a preferred language. You must restart the software for the language to take effect.

1. Click **File > Settings > Change Language**.

The Choose a Language dialog box opens.

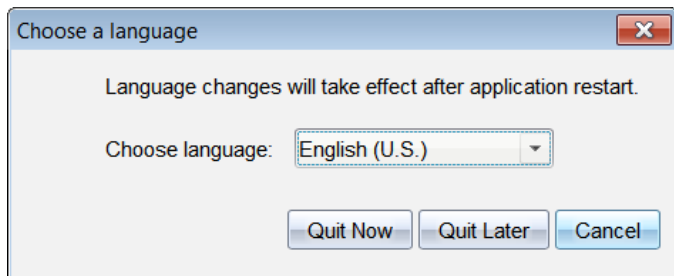

2. Click ▼ to open the Choose language drop-down list.
3. Select the desired language.
4. Click **Quit Now** to close the software immediately. You will be prompted to save any open documents. When you restart the software, the language change is effective.

—or—

Click **Quit Later** to continue your work. The language change is not applied until you close and restart the software at a later time.

## Using Software Menu Shortcuts

Use the following software menu shortcuts to perform common functions.

**Note:** Mac® users should substitute ⌘ (Cmd) anywhere Ctrl is used.

Getting Help	
Help	F1
Online Help	F2
Editing Text	
Cut	Ctrl+X
Copy	Ctrl+C
Paste	Ctrl+V
Undo	Ctrl+Z Ctrl+Esc
Redo	Ctrl+Y Shift+Esc
Toggle approximate and exact results	Ctrl+Enter
<b>Python Editor and Shell:</b> Add a new line after the current line.	
Inserting Characters and Symbols in a document	
Manual data capture point	Ctrl+.
Equals symbol	=
Insert variable	Ctrl+L



<b>Managing Documents</b>	
Display Document Tools menu	<b>Ctrl+Shift+M</b>
Open document	<b>Ctrl+O</b>
Close document	<b>Ctrl+W</b>
Create new document	<b>Ctrl+N</b>
Insert new page	<b>Ctrl+I</b>
Select application	<b>Ctrl+K</b>
Save current document	<b>Ctrl+S</b>
<b>Navigation</b>	
Top of page  <b>Python Editor and Shell:</b> Moves cursor to the beginning of the first line in the program.	<b>Ctrl+7</b>
End of page  <b>Python Editor and Shell:</b> Moves cursor to the end of the last line in the program.	<b>Ctrl+1</b>
Page Up	<b>Ctrl+9</b>
Page Down	<b>Ctrl+3</b>
Up a level in the hierarchy	<b>Ctrl+▲</b>
Down a level in the hierarchy	<b>Ctrl+▼</b>
Extends selection in direction of arrow	<b>Shift+Any arrow</b>
<b>Python Editor and Shell:</b> Indents text on the current line or selected lines or navigates between inline prompts	<b>Tab</b>
<b>Navigating in Documents</b>	
Displays previous page	<b>Ctrl+◀</b>
Displays next page	<b>Ctrl+▶</b>



































Displays Page Sorter	Ctrl+▲
Exits Page Sorter	Ctrl+▼
Moves focus backward within page  <b>Python Editor and Shell:</b> Dedents text on the current line or selected lines or navigates backwards between inline prompts	Shift+Tab
<b>Wizards and Templates</b>	
Add a column to a matrix after the current column	Shift+Enter
Add a row to a matrix after the current row  <b>Python Editor and Shell:</b> Add a new line after the current line.	Enter
<b>Application-Specific Shortcuts</b>	
<b>Notes/Program Editor/Python Editor:</b> Select all  <b>Press-to-Test:</b> Select all items in the dialog	Ctrl+A
<b>Program Editor/Python Editor:</b> Check syntax and store	Ctrl+B
<b>Program Editor/Python Editor:</b> Find	Ctrl+F
<b>Geometry/Graph:</b> Hide/Show Entry Line  <b>Lists &amp; Spreadsheet/Program Editor/Python Editor:</b> Go To	Ctrl+G
<b>Program Editor/Python Editor:</b> Find and Replace	Ctrl+H
<b>Calculator/Program Editor/Python Editor and Shell:</b> Beginning of line	Ctrl+8
<b>Calculator/Program Editor/Python Editor and Shell:</b> End of line	Ctrl+2
<b>Notes:</b> Insert math expression box	Ctrl+M
<b>Notes:</b> Insert chemical equation box	Ctrl+E
<b>Lists &amp; Spreadsheet:</b> Recalculate	Ctrl+R

<p><b>Program Editor:</b> Check syntax, store program and paste program name in Calculator (after clearing current line in Calculator)</p> <p><b>Python Editor:</b> Check syntax, save program and execute in Python Shell</p> <p><b>Python Shell:</b> Rerun last program</p>	
<p><b>Geometry/Graphs/Lists &amp; Spreadsheet:</b> Add Function Table</p> <p><b>Program Editor/Python Editor and Shell:</b> Add/remove comment symbol</p>	<b>Ctrl+T</b>
Group/Ungroup applications on a page	<b>Ctrl+4 / Ctrl+6</b>
<b>Miscellaneous</b>	
Handheld Preview	<b>Alt+Shift+H</b>
Computer Preview	<b>Alt+Shift+C</b>
Transfer Tool (Teacher Software only)	<b>Ctrl+Shift+T</b>
Quick Poll (Teacher Software only)	<b>Ctrl+Alt+Q</b>
Capture Class (Teacher Software only)	<b>Ctrl+Shift+R</b>
Capture Page	<b>Ctrl+J</b>
Rename (Content Workspace only)	<b>F2</b>
Print	<b>Ctrl+P</b>
Exit Software	<b>Alt+F4</b>

































### ***Using Handheld Keyboard Shortcuts***



























Use the following handheld emulator keyboard shortcuts to perform common functions.































<b>Getting Help</b>	
Open Hints	 





Editing Text	
Cut	 
Copy	 
Paste	 
Undo	   
Redo	   
Toggle approximate and exact results	 
<b>Python Editor and Shell:</b> Add a new line after the current line.	
English: Change key to include appropriate accent Chinese: Insert character	
Inserting Characters and Symbols in a document	
Display character/symbol palette	 
Underscore	 
Display math template palette	
Backslash ( \ )	 
Manual data capture point	 
Clear	 
Caps Lock	 
Store	 
Square brackets	 



Curly brackets	 
Display Trig symbol palette	
Equals symbol	
Display pi symbols palette ( $\pi$ , $\frac{1}{\pi}$ , $\theta$ , and so on)	
Display equality/inequality palette ( $>$ , $<$ , $\neq$ , $\leq$ , $\geq$ , and $ $ )	 
Display marks and letter symbols palette ( $?$ $!$ $\$$ $^$ $'$ $%$ $"$ $:$ $;$ $_$ $\backslash$ )	
Square root	 
log	 
ln	 
ans	 
<b>Managing Documents</b>	
Open document menu	
Open document	 
Close document	 
Create new document	 
Insert new page	 
Select application	 
Save current document	   
<b>Navigation</b>	
Top of page	 

<b>Python Editor and Shell:</b> Moves cursor to the beginning of the first line in the program.	
End of page  <b>Python Editor and Shell:</b> Moves cursor to the end of the last line in the program.	 
Page Up	 
Page Down	 
Up a level in the hierarchy	 
Down a level in the hierarchy	 
Context menu for selection	
Extends selection in direction of arrow	 Any arrow
<b>Python Editor and Shell:</b> Indents text on the current line or selected lines or navigates between inline prompts	
<b>Navigating in Documents</b>	
Displays previous page	 
Displays next page	 
Displays Page Sorter	 
Exits Page Sorter	 
Switch between applications on a split page	 
Moves focus backward within page  <b>Python Editor and Shell:</b> Dedents text on the current line or selected lines or navigates backwards between inline prompts	 
<b>Wizards and Templates</b>	
Add a column to a matrix after the current column	 

Add a row to a matrix after the current row  <b>Python Editor and Shell:</b> Add a new line after the current line.	
Integration template	 
Derivative template	 
Math template palette	 OR  
Fraction template	 
<b>Modifying Display</b>	
Increase contrast	 
Decrease contrast	 
Power off	  ON
<b>Application-Specific Shortcuts</b>	
<b>Notes/Program Editor/Python Editor:</b> Select all	 
<b>Press-to-Test:</b> Select all items in the dialog	
<b>Program Editor/Python Editor:</b> Check syntax and store	 
<b>Program Editor/Python Editor:</b> Find	 
<b>Geometry/Graph:</b> Hide/Show Entry Line	 
<b>Lists &amp; Spreadsheet/Program Editor/Python Editor:</b> Go To	
<b>Program Editor/Python Editor:</b> Find and Replace	 
<b>Calculator/Program Editor/Python Editor and Shell:</b> Beginning of line	 
<b>Calculator/Program Editor/Python Editor and Shell:</b> End of line	 

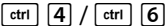
<b>Notes:</b> Insert math expression box	
<b>Notes:</b> Insert chemical equation box	
Open the Scratchpad	
<b>Lists &amp; Spreadsheet:</b> Recalculate  <b>Program Editor:</b> Check syntax, store program and paste program name in Calculator (after clearing current line in Calculator)  <b>Python Editor:</b> Check syntax, save program and execute in Python Shell  <b>Python Shell:</b> Rerun last program	
<b>Geometry/Graphs/Lists &amp; Spreadsheet:</b> Add Function Table  <b>Program Editor/Python Editor and Shell:</b> Add/remove comment symbol	
Group/Ungroup applications on a page	

# Using the Documents Workspace

Use this workspace to create, modify, and view TI-Nspire™ documents, and to demonstrate mathematical concepts.

## Exploring the Documents Workspace

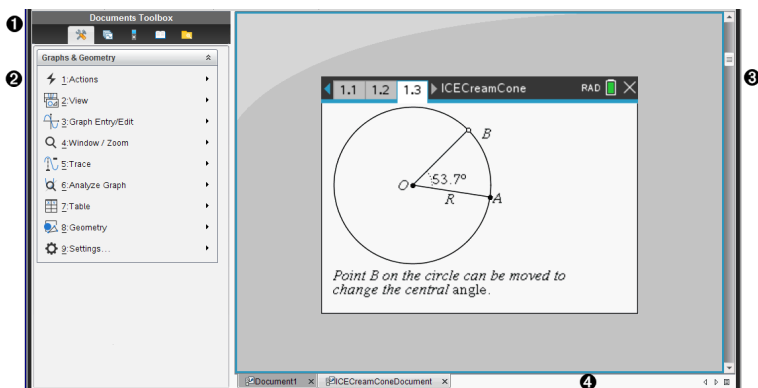

- 1 Documents Toolbox.** Contains tools such as the Document Tools menu, Page Sorter, TI-SmartView™ emulator, Utilities, and Content Explorer. Click each icon to access the available tools. When you are working in a TI-Nspire™ document, the tools available are specific to that document.
- 2 Toolbox pane.** Options for the selected tool are displayed in this area. For example, click the Document Tools icon to access tools needed to work with the active application.  
**Note:** In the TI-Nspire™ CX Premium Teacher Software, the tool for configuring questions opens in this space when you insert a question. For more information, see *Using Question in the Teacher Software*.
- 3 Work area.** Shows the current document and enables you to perform calculations, add applications and add pages and problems. Only one document at a time is active (selected). Multiple documents appear as tabs.
- 4 Document information.** Shows the names of all open documents. When there are too many open documents to list, click the forward and backward arrows to scroll through the open documents.

## Using the Documents Toolbox

The Documents Toolbox, located on the left side of the workspace, contains tools needed for working with TI-Nspire™ documents. When you click a toolbox icon, the associated tools appear in the Toolbox pane.

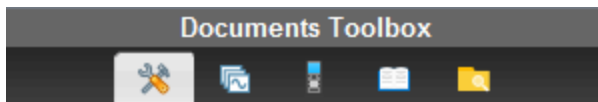

## Exploring Document Tools

In the following example, the Document Tools menu is open showing the options for the Calculator application. In TI-Nspire™ documents, the Document Tools menu contains tools available for working with an application. The tools are specific to the active application.

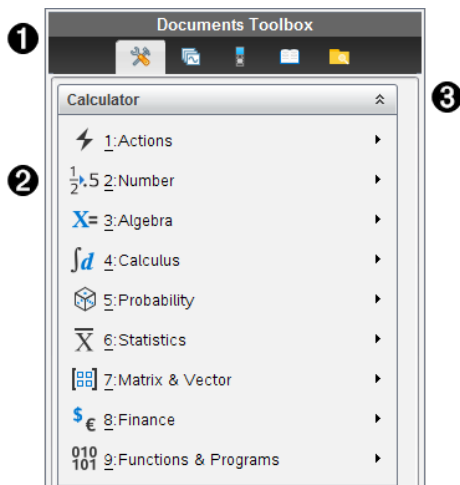

- 1 The Documents Toolbox menu.
- 2 Tools available for the Calculator application. Click ► to open the submenu for each option.
- 3 Click ▲ to close and click ▼ to open Document Tools.

## Exploring the Page Sorter

The following example shows the Documents Toolbox with the Page Sorter open. Use the Page Sorter to:

- See the number of problems in your document and where you are.
- Move from one page to another by clicking on the page you want.
- Add, cut, copy, and paste pages and problems within the same document or between documents.

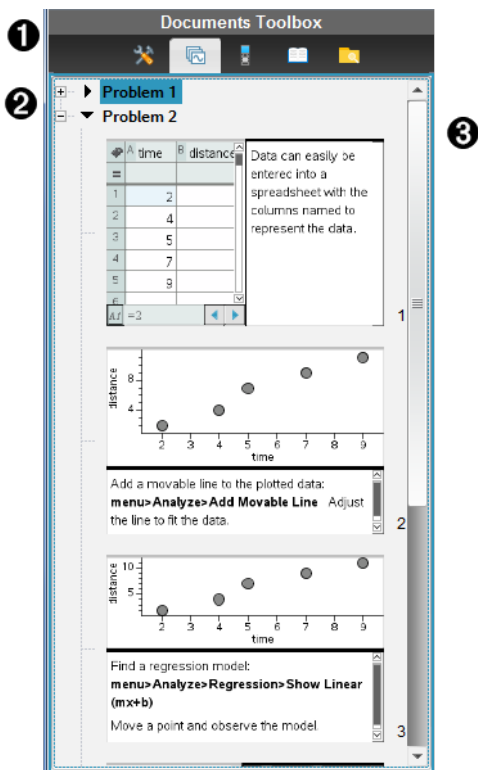

- 1 The Documents Toolbox menu.
- 2 Click the minus sign to collapse the view. Click the + sign to open the view and show pages in the document.
- 3 Scroll bar. The scroll bar is only active when there are too many pages to show in the pane.

## Exploring the TI-SmartView™ Feature

The TI-SmartView™ feature emulates how a handheld works. In the teacher software, the emulated handheld facilitates classroom presentations. In the student software, the emulated keypad gives students the ability to drive the software as if using a handheld.

**Note:** Content is displayed on the TI-SmartView™ small screen only when the document is in Handheld view.

**Note:** The following illustration shows the TI-SmartView™ panel in the teacher software. In the Student Software, only the keypad is shown. For more information, see Using the TI-SmartView™ Emulator.

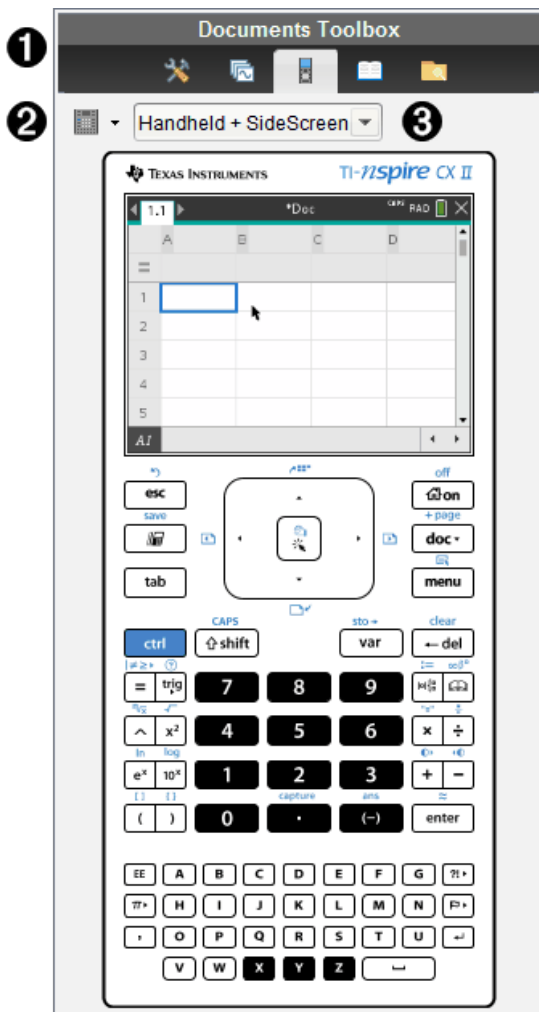

- 1 The Documents Toolbox menu.
- 2 Keypad Options. Click ▼ to select how to show the handheld:
  - Dark
  - Light
  - Outline
- 3 View selector. In the teacher software, click ▼ to select the handheld view:
  - Handheld Only



- Keypad + SideScreen
- Handheld + SideScreen

**Note:** You can also change these options in the TI-SmartView™ Options window. Click **File > Settings > TI-Smartview™ Options** to open the window.

**Note:** The view selector is not available in the student software.

When the Handheld Only display is active, select **Always in Front** to keep the display in front of all other open applications. (Teacher software only.)



## Exploring Content Explorer

Use Content Explorer to:

- See a list of files on your computer.
- Create and manage lesson bundles.
- If using software that supports connected handhelds, you can:
  - See a list of files on any connected handheld.
  - Update the OS on connected handhelds.
  - Transfer files between a computer and connected handhelds.

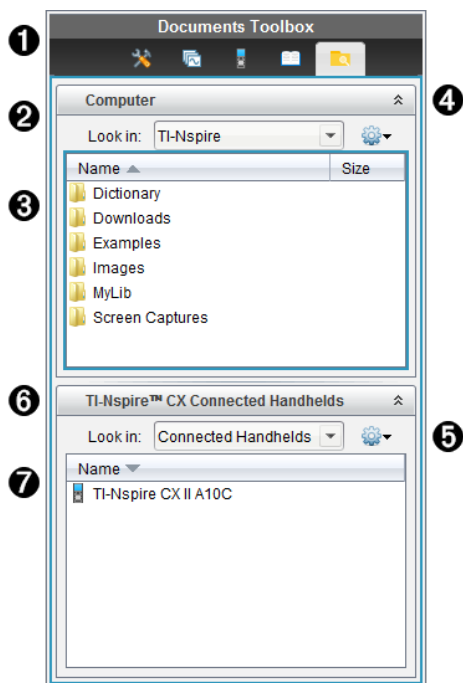
**Note:** If you are using TI-Nspire™ software that does not support connected handhelds, the Connected Handheld heading is not shown in the Content Explorer pane.



- 1 The Documents Toolbox menu.
- 2 Shows files on your computer and the name of the folder where the files are located. Click ▼ to navigate to another folder on the computer.
- 3 The list of folders and files within the folder named in the **Look In:** field. Right-click on a highlighted file or folder to open the context menu listing available actions for that file or folder.
- 4 Click  to close the list of files. Click  to open the list of files.
- 5  Options menu. Click ▼ to open the menu of actions you can perform on a selected file:
  - Open an existing file or folder.
  - Move (navigate) up one level in the folder hierarchy.
  - Create a new folder.
  - Create a new lesson bundle.
  - Rename a file or folder.
  - Copy selected file or folder.
  - Paste file or folder copied to Clipboard.
  - Delete selected file or folder.
  - Select all files in a folder.
  - Package lesson bundles.
  - Refresh the view.
  - Install OS.
- 6 Connected handhelds. Lists the connected handhelds. Multiple handhelds are listed if more than one handheld is connected to the computer or when using the TI-Nspire™ Docking Stations.
- 7 The name of the connected handheld. To show the folders and files on a handheld, double-click the name.  
Click ▼ to navigate to another folder on the handheld.

## Exploring Utilities

Utilities provides access to the math templates and operators, special symbols, catalogue items, and libraries that you need when working with documents. In the following example, the Math templates tab is open.

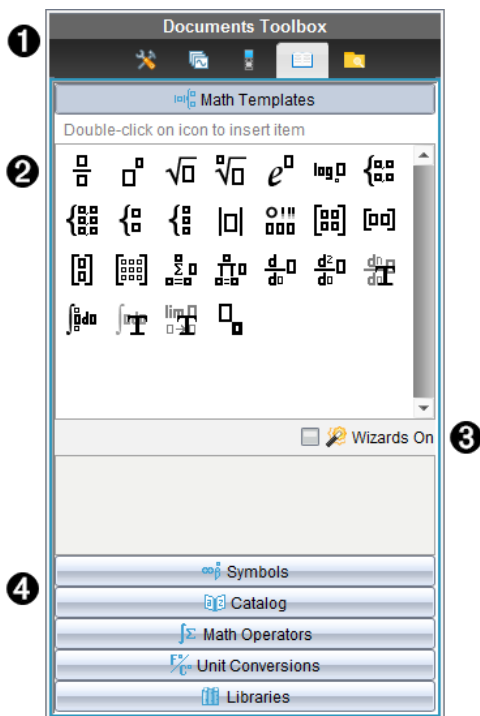

- 1 The Documents Toolbox menu.
- 2 Math Templates are open. Double-click a template to add it to a document. Click the Math Template tab to close the template view.  
To open the Symbols, Catalogue, Math Operators, and Libraries, click the tab.
- 3 Wizards On check box. Select this option to use a wizard to enter function arguments.
- 4 Tabs for opening views where you can select and add symbols, catalogue items, math operators, and library items to a document. Click the tab to open the view.

## Using the Work Area

The space on the right side of the workspace provides an area for creating and working with TI-Nspire™ documents. This work area provides a view of the document so that you can add pages, add applications, and perform all work. Only one document at a time is active.

When you create a document, you specify its page size as Handheld or Computer. This is how the page is displayed in the work area.

- **Handheld** page size is optimized for the smaller screen of a handheld. This page size can be viewed on handhelds, computer screens, and tablets. The content is scaled when viewed on a larger screen.

- **Computer** page size takes advantage of the larger space of a computer screen. These documents can show details with less scrolling required. The content is not scaled when viewed on a handheld.

You can change the page preview to see how the document will look in a different page size.

- ▶ To change the page preview, click **Document Preview** on the toolbar, and then click **Handheld** or **Computer**.



For more information on page size and document preview, see *Working with TI-Nspire™ Documents*.

## Changing Document Settings

Document settings control how all numbers, including elements or matrices and lists, are displayed in TI-Nspire™ documents. You can change the default settings at anytime and you can specify settings for a specific document.

### Changing Document Settings

1. Create a new document or open an existing document.
2. From the TI-Nspire™ **File** menu, select **Settings > Document Settings**.

The Document Settings dialogue box opens.

When you open Document Settings the first time, the default settings are displayed.

3. Press **Tab** or use your mouse to move through the list of settings. Click ▼ to open the drop-down list to view the available values for each setting.

Field	Values
Display Digits	<ul style="list-style-type: none"> <li>• Float</li> <li>• Float1 - Float12</li> <li>• Fix0 - Fix12</li> </ul>
Angle	<ul style="list-style-type: none"> <li>• Radian</li> <li>• Degree</li> <li>• Gradian</li> </ul>
Exponential Format	<ul style="list-style-type: none"> <li>• Normal</li> <li>• Scientific</li> <li>• Engineering</li> </ul>

Field	Values
Real or Complex	<ul style="list-style-type: none"> <li>• Real</li> <li>• Rectangular</li> <li>• Polar</li> </ul>
Calculation Mode	<ul style="list-style-type: none"> <li>• Auto</li> <li>• Exact</li> <li>• Approximate</li> </ul> <p><b>Note:</b> Auto mode shows an answer that is not a whole number as a fraction except when a decimal is used in the problem. Exact mode (CAS only) shows an answer that is not a whole number as a fraction or in symbolic form, except when a decimal is used in the problem.</p>
Exact Arithmetic	<ul style="list-style-type: none"> <li>• On</li> <li>• Off</li> </ul> <p><b>Note:</b> This option is only available on Exact Arithmetic handhelds.</p>
CAS Mode	<ul style="list-style-type: none"> <li>• On</li> <li>• Exact Arithmetic</li> <li>• Off</li> </ul> <p><b>Note:</b> This option is only available on CAS handhelds and software.</p>
Vector Format	<ul style="list-style-type: none"> <li>• Rectangular</li> <li>• Cylindrical</li> <li>• Spherical</li> </ul>
Base	<ul style="list-style-type: none"> <li>• Decimal</li> <li>• Hex</li> <li>• Binary</li> </ul>
Unit System	<ul style="list-style-type: none"> <li>• SI</li> <li>• Eng/US</li> </ul> <p><b>Note:</b> This option is only available on CAS handhelds and software.</p>

4. Click the desired setting.

5. Choose one of the following options:

- To apply the settings to the open document and to Scratchpad, and to make default for new applications, click **OK**.
- Click **Cancel** to close the dialogue box without making changes.

## Changing Graphs & Geometry Settings

Graphs & Geometry settings control how information is displayed in open problems and in subsequent new problems. When you change the Graphs & Geometry settings, the selections become the default settings for all work in these applications.

Complete the following steps to customise the application settings for graphs and geometry.

1. Create a new graphs and geometry document or open an existing document.
2. In the Documents Toolbox, click  to open the Graphs & Geometry application menu.
3. Click **Settings > Settings**.

The Graphs & Geometry Settings dialog box opens.

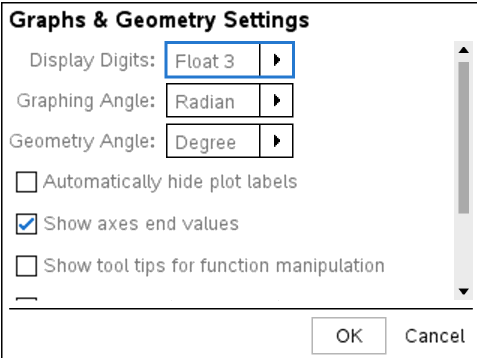

**Graphs & Geometry Settings**

Display Digits:

Graphing Angle:

Geometry Angle:

Automatically hide plot labels

Show axes end values

Show tool tips for function manipulation

4. Press **Tab** or use your mouse to move through the list of settings. Click **▶** to open the drop-down list to view the available values for each setting.

Field	Values
Display Digits	<ul style="list-style-type: none"><li>• Auto</li><li>• Float</li><li>• Float1 - Float12</li><li>• Fix0 - Fix12</li></ul>
Graphing Angle	<ul style="list-style-type: none"><li>• Auto</li><li>• Radian</li><li>• Degree</li><li>• Gradian</li></ul>
Geometry Angle	<ul style="list-style-type: none"><li>• Auto</li><li>• Radian</li><li>• Degree</li><li>• Gradian</li></ul>

5. Select the desired setting.
6. Select a checkbox to enable an option or clear a checkbox to disable an option.

Check box	Operation when selected
Automatically hide plot labels	Plot labels are displayed only when selected, grabbed or hovered.
Show axis end values	A numeric label is displayed at the least and greatest values visible on an axis
Show tool tips for function manipulation	Shows helpful information as you manipulate function graphs
Automatically find a point of interest	Shows zeros, minima and maxima for graphed functions and objects while tracing function graphs.

7. Choose one of the following options:
  - To apply the settings to the open document and to Scratchpad, and to make default for new Graphs and Geometry applications, click **OK**.
  - Click **Cancel** to close the dialogue box without making changes.

## Working with Connected Handhelds

The TI-Nspire™ software enables you to view content, manage files, and install operating system updates on handhelds connected to the computer.

To use the features described in this chapter, handhelds must be turned on and connected by one of these means:

- TI-Nspire™ Docking Station or TI-Nspire™ CX Docking Station
- TI-Nspire™ Navigator™ Cradle and access point
- TI-Nspire™ CX Wireless Network Adapter and access point
- TI-Nspire™ CX Wireless Network Adapter - v2 and access point
- A direct connection through a standard USB cable

For web-based connectivity using your TI-Nspire™ CX II with a Chromebook, Windows® computer, or Mac® computer, go to [TI-Nspire™ CX II Connect](#).

**Note:** The tasks in this section can only be performed using TI-Nspire™ handhelds. In order to enable wireless connectivity, the TI-Nspire™ Premium Teacher Software and the OS installed on the TI-Nspire™ CX II handhelds must be version 5.0 or later. For TI-Nspire™ CX handhelds, the OS must be version 4.0 or later.

### *Managing Files on a Connected Handheld*

When working with files on connected handhelds in the Content Workspace, use the

Options menu  or the context menu to manage files.

Option	How it Works
Open	Open a file on a connected handheld: <ul style="list-style-type: none"><li>• Click the file you want to open.</li><li>• Click <b>Open</b>. The document opens in the Documents Workspace.</li></ul>
Save to Computer	Save a copy of the selected file on your computer. <ul style="list-style-type: none"><li>• Click the file you want to save.</li><li>• Click <b>Save to Computer</b>. The Save Select File dialogue box opens.</li><li>• Navigate to the folder where you want to save the file.</li><li>• Click <b>Save</b>.</li></ul>
Copy/Paste	Create a copy of a file: <ul style="list-style-type: none"><li>• Click the file you want to copy.</li><li>• Click <b>Options &gt; Copy</b> to copy the file to the Clipboard.</li><li>• To paste the file in another location, navigate to the new location and then click <b>Options &gt; Paste</b>.</li></ul> <p><b>Note:</b> If you don't select a new location, the copied file is</p>



Option	How it Works
	pasted with a new name "Copy of ..."
Delete	Delete a file on a connected handheld: <ul style="list-style-type: none"> <li>• Click the file you want to delete.</li> <li>• Click <b>Delete</b>.</li> <li>• Click <b>Yes</b> when the Warning dialogue box opens. Click <b>No</b> to cancel.</li> </ul>
Refresh	To refresh the list of files, click <b>Options &gt; Refresh</b> .
Rename	To rename a file on a connected handheld: <ul style="list-style-type: none"> <li>• Click the file you want to rename.</li> <li>• Click <b>Rename</b>.</li> <li>• Type the new name and press <b>Enter</b>.</li> </ul>
Up a Level	Go up a level in the folder hierarchy. This option is available when you select a file inside a folder.
New Folder	Create a new folder: <ul style="list-style-type: none"> <li>• Click <b>New Folder</b>.</li> <li>• Type a name for the new folder.</li> <li>• Press <b>Enter</b>.</li> </ul>

### Opening Documents on Connected Handhelds

To open a document on a connected handheld in the TI-Nspire™ software:

1. Ensure the handheld is connected to your computer.
2. Click  to open Content Explorer.  
The connected handheld name is listed in the Connected Handhelds pane.
3. Double-click the handheld name.  
The folders and documents on the handheld are listed.
4. Navigate to the document you want to open, and then double-click the file name.  
The document opens in the Documents Workspace work area.

### Saving Files to a Connected Handheld

When you save a file from your computer to a handheld, files are converted to TI-Nspire™ documents (.tns files). To save a file on your computer to a connected handheld:

1. Ensure the handheld is connected to your computer.
2. Click  to open Content Explorer.  
The folders and files on your computer are listed in the Computer pane.

3. Navigate to the folder or file you want to save to the handheld.
4. Click the file to select it.
5. Drag the file to a connected handheld listed in the Connected Handheld pane.

The file is saved to the connected handheld.

**Note:** To save the file in a folder on the handheld, double-click the handheld name to list the folders and files, and then drag the file to a folder on the handheld.

If the file already exists on the handheld, a dialogue box opens asking if you want to replace the file. Click **Replace** to overwrite the existing file. Click **No** or **Cancel** to abandon the save.

## Checking for an OS Update

When handhelds are connected, you can check for OS updates from the Content Workspace or from the Documents Workspace.

1. Show all connected handhelds.
  - In the Content Workspace, click **Connected Handhelds** in the Resources pane.
  - In the Documents Workspace, open the Content Explorer and click **Connected Handhelds**.
2. Click the handheld you want to check, and then right-click and select **Check for OS Update**.
  - If the operating system is current, the Check for Handheld OS Update dialogue box opens indicating that the operating system on the handheld is current.

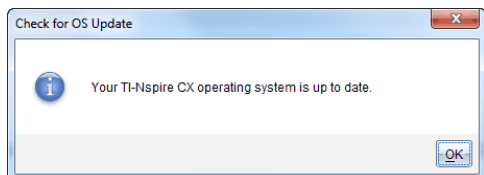

- If the operating system is not current, the TI-Nspire™ software prompts you to install the latest OS now, with the option to download the OS to your computer.

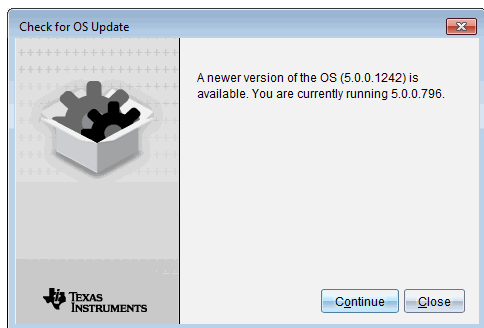

3. Click **Close** to close the dialogue box, or click **Continue** and follow the prompts to install the OS on the handheld.

## Installing an OS Update

**Note:** To avoid losing unsaved data, close all documents on the handheld before updating its operating system (OS). Updating the OS does not replace or remove previously saved documents.

The OS on a new handheld comes bundled with the installer, which places the OS in a default location such as: C:\mydocuments\TI-Nspire\downloads.

Go to [education.ti.com/latest](http://education.ti.com/latest) to download the latest OS files.

**Note:** You can install OS updates on connected handhelds from the Content Workspace at any time.

### Updating the OS on a Single Handheld

1. Ensure that your computer is connected to the internet.
2. Show all connected handhelds by clicking the arrow next to **TI-Nspire™ Connected Handhelds** in the Resources pane.

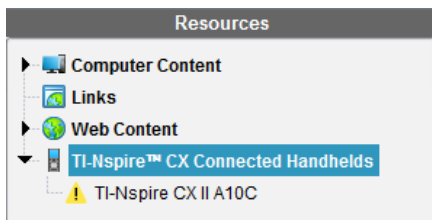

**Note:** An attention  symbol next to a handheld name means:

The handheld needs an OS update.

—or—

The handheld has a newer OS than the teacher's.

3. Hover your mouse over the TI-Nspire™ handheld you want to update, and then right-click.
4. Click **Check for OS Update**.

The Check for OS Update dialogue box opens.

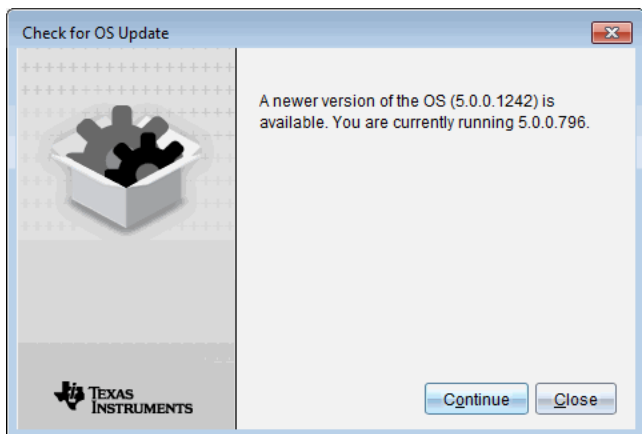

5. Click **Close** to cancel the installation, or click **Continue** and follow the prompts to install the OS on the handheld.

When the update is complete, the handheld restarts automatically.

### Updating the OS on Multiple Handhelds

**Note:** To avoid losing unsaved data, close all documents on the handheld before updating its operating system (OS). Updating the OS does not replace or remove previously saved documents.

1. Click **TI-Nspire™ Connected Handhelds** in the Resources pane.
2. Select all handhelds you want to update in the Content Pane.
3. Click **Tools > Install OS**.

The OS Installation dialogue box opens.

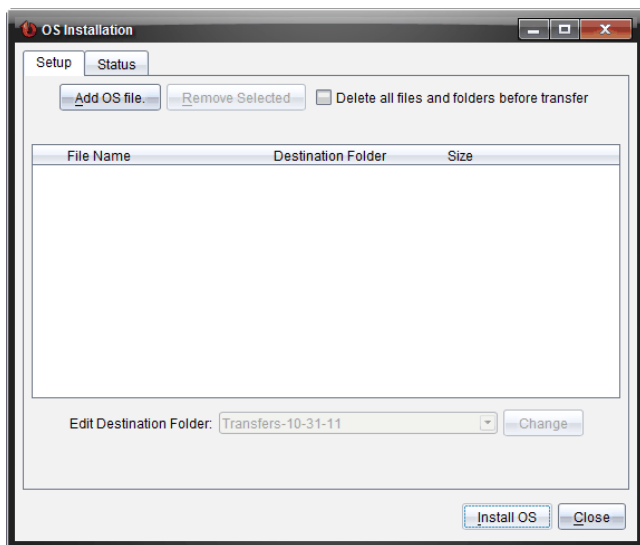

4. Click **Add OS file**.

The Add to Transfer List dialogue box opens.

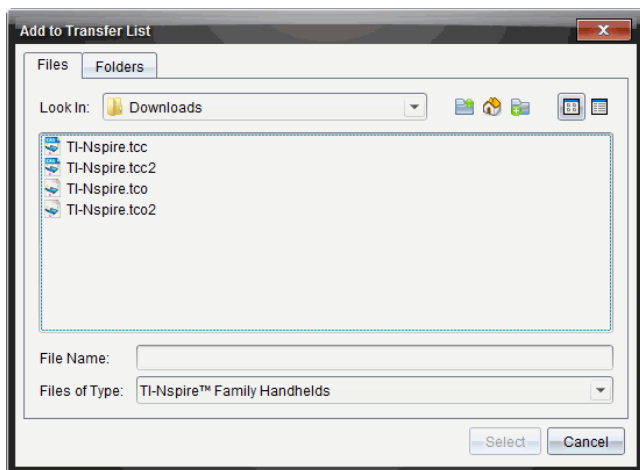

5. Select the applicable OS files.

- To upgrade a TI-Nspire™ CX handheld, select TI-Nspire.tco.
- To upgrade a TI-Nspire™ CX CAS handheld, select TI-Nspire.tcc.
- To upgrade a TI-Nspire™ CX II handheld, select TI-Nspire.tco2.

- To upgrade a TI-Nspire™ CX II CAS handheld, select TI-Nspire.tcc2.
- To upgrade a TI-Nspire™ CX II-T handheld, select TI-Nspire.tct2.

6. Click **Select**.

The OS Installation redisplay with your selected OS files.

7. Click **Install OS**.

The OS version information updates, and the Select OS Handheld File dialogue redisplay for further selection.

# Working with TI-Nspire™ Documents

All work that you create and save using TI-Nspire™ applications is stored as a document (.tns file), which you can share with others using TI-Nspire™ software and with those using handhelds.

## TI-Nspire™ Documents

A TI-Nspire™ document consists of one or more problems. Each problem can contain one or more pages. A single page is displayed in the work area. All work occurs in the applications within pages.

Because the TI-Nspire™ software and handhelds share the same functionality, you can transfer TI-Nspire™ documents between computers and handhelds. When you create a document, you select one of two page sizes.

- **Handheld.** Size: 320 × 217 pixels. This size allows documents to be viewed on all platforms. The content will be scaled when viewed on a tablet or larger screen.
- **Computer.** Size: 640 × 434 pixels. The content will not be scaled when viewed on smaller platforms. Some content may not be visible on a handheld device.

You can convert a document from one page size to the other any time.

## Creating a New TI-Nspire™ Document

When you open the software, the Documents Workspace opens with a blank document containing one problem. You can add applications and content to this problem to create a document.

**Note:** The Welcome Screen is displayed when you open the software if the "always show this at startup" option is selected. Click an application icon to add a problem with an active application to a new document.

To create a new document, complete the following steps:

1. On the TI-Nspire™ **File** menu,
  - Select **New TI-Nspire™ Document - Handheld Page Size**.
  - or-
  - Select **New TI-Nspire™ Document - Computer Page Size**.

The new document opens in the Documents Workspace, and you are prompted to select an application.

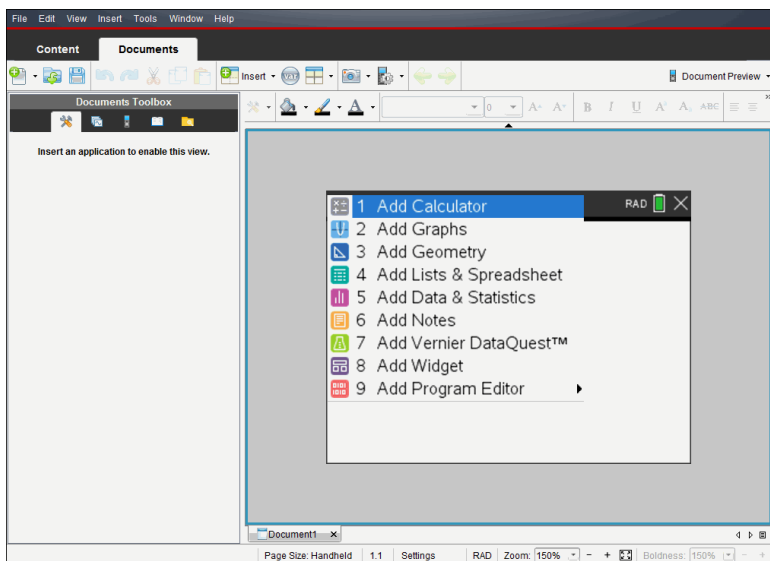

2. Select an application to add a problem to the document.

The problem is added to the document.

### ***Opening an Existing Document***

To open an existing document:

1. Click **File > Open Document**.

—or—



Click .

The Open dialogue box opens.



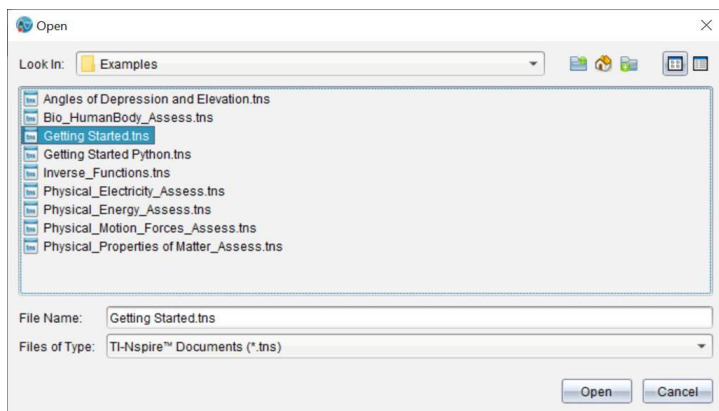

2. Use the file browser to locate the file you want to open and click the file to select it.
3. Click **Open**.

The document opens in the work area.

**Note:** To select from your 10 most recent documents, click **File > Recent Documents** and select a document from the drop-down list.

## ***Saving TI-Nspire™ Documents***

To save a new document:

1. Click **File > Save Document** or click  .

The Save TI-Nspire™ Document dialogue box opens.

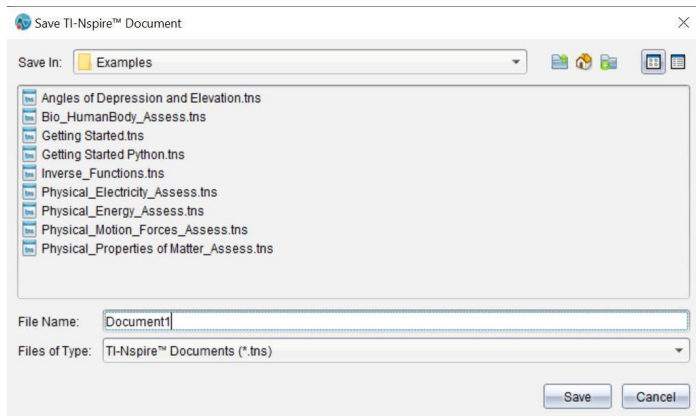

2. Navigate to the folder where you want to save the document or create a folder in which to store the document.
3. Type a name for the new document.
4. Click **Save** to save the document.

The document closes and is saved with the extension .tns.

**Note:** When you save a file, the software looks in the same folder the next time you open a file.

### **Saving a Document with a New Name**

To save a previously saved document in a new folder and/or with a new name:

1. Click **File > Save As**.

The Save TI-Nspire™ Document dialog box opens.

2. Navigate to the folder where you want to save the document or create a folder in which to store the document.
3. Type a new name for the document.
4. Click **Save** to save the document with a new name.

### **Deleting Documents**

File deletions on your computer are sent to the Recycle bin and can be retrieved if the Recycle bin has not been emptied.

**Note:** File deletions on the handheld are permanent and cannot be undone, so be sure that you want to delete the file that you select.

1. Select the document you want to delete.
2. Click **Edit > Delete** or press **Delete**.

The Warning dialog box opens.

3. Click **Yes** to confirm the delete.

The document is deleted.

### **Closing Documents**

- ▶ To close a document, click **File > Close** or click the **Close** icon on the document tab at the bottom of the document.







- ▶ If working in tiled view, click the **Close** icon in the upper right corner of the document window.

## Formatting Text in Documents

Use the text formatting tools to format text in TI-Nspire™ applications that allow text input. By default, the text formatting toolbar opens in the area above an active document. Options on the toolbar are enabled or disabled depending on the active application.

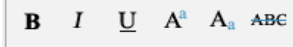

Option	Function
	Click ▼ to open the menu for the active application. This tool enables you to open an application menu regardless of the option selected in the Documents Toolbox.
	Click ▼ to select a background colour for highlighting text or choose a fill colour for a selected cell.
	Click ▼ to select the line colour for an object. For example, in Graphs & Geometry, you can choose a colour for a selected shape.
	Click ▼ to select a colour for selected text.
	Use these tools to choose a font and set the size of the font. <ul style="list-style-type: none"> <li>Click ▼ to select a different font from the drop-down box.</li> <li>To select a specific font size, click ▼ to select a size from the drop-down box.</li> <li>Click <math>A^</math> to increase the font size or click <math>A_</math> to decrease the font size incrementally.</li> </ul>
	Click the appropriate tool to apply bold, italics or underlining; apply superscript or subscript; or strike out text.

### Hiding and Showing the Formatting Toolbar

- ▶ When the formatting toolbar is visible, click ▲ (located under the toolbar) to hide the toolbar.

- Click ▼ to show the toolbar when the formatting toolbar is hidden.

## **Using Colours in Documents**

In the TI-Nspire™ applications that allow formatting, you can use colour in filled areas of an object, or in lines or text, depending on the application you are using and how you have selected the item. If the icon or menu item that you want to use is not available (dimmed) after you have selected an item, colour is not an option for the selected item.

Colours appear in documents opened on your computer and on the TI-Nspire™ CX handheld.

**Note:** For more information about using colour in a TI-Nspire™ application, see the chapter for that application.

### **Adding Colour from a List**

To add colour to a fill area, line or text, complete the following steps:

1. Select the item.
2. Click **Edit > Colour** or select where you want to add colour (fill, line or text).
3. Select the colour from the list.

### **Adding Colour from a Palette**

To add colour using the palette, complete the following steps:

1. Select the object.
2. Click the appropriate toolbar icon.
3. Select the colour from the palette.

## **Setting Page Size and Document Preview**

When you create a document, you specify its page size as Handheld or Computer, depending on how you expect the document to be used. Documents of both page sizes can be opened on either platform, and you can convert the page size any time.

- **Handheld.** Size: 320 × 217 pixels, fixed. Handheld documents can be viewed on all platforms. You can magnify (zoom) the content when viewing it on a tablet or larger screen.
- **Computer.** Size: 640 × 434 pixels, minimum. Computer documents scale up automatically to take advantage of higher resolution screens. The minimum size is 640 × 434, so some content may be clipped on handheld devices.

**Note:** You can view documents of either page size using Handheld or Computer preview.

### **Converting the Current Document's Page Size**

- On the main TI-Nspire™ **File** menu, select **Convert to**, and then select the page size.

The software saves the current document and creates a copy that uses the requested page size.

### Viewing the Document in Handheld Preview

1. On the application toolbar, click **Document Preview**, and select **Handheld**.

The preview changes. This does not change the document's underlying page size.

2. (Optional) Adjust the viewing magnification:

- (Optional) Click the **Zoom** tool beneath the work area, and select a magnification value for the preview.

—or—

- Click the **Zoom to Fit** button  to make the handheld preview adjust automatically to the window size.

### Viewing the Document in Computer Preview

1. On the application toolbar, click **Document Preview**, and select **Computer**.

The preview changes. This does not change the document's underlying page size.

2. (Optional) Click the **Boldness** tool beneath the work area, and select a value to increase or decrease the boldness of text and other items.

### Setting a Default Preview

By default, when you open a document, it is automatically displayed using the preview that matches its page size. You can override the rule and specify a preview that you prefer.

1. On the main TI-Nspire™ **File** menu, select **Settings > Preview Settings**.
2. Select the preview that you want documents to use when you open them.

### Working with Multiple Documents

When multiple documents are open, document names are listed in tabs at the bottom of the work area. Only one document is active at a time, and only the active document is affected by commands from menus or tools.

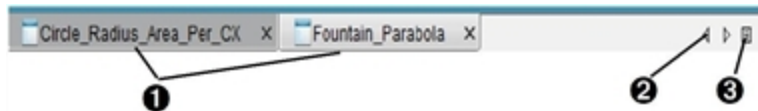

To switch between documents:

- 1 Click the tab to show a document in the work area. This document becomes the active document. If the Show Documents in Tiles view is open, these tabs are not shown.
- 2 Use the right and left arrows to scroll through the list of documents. These arrows are active only when there are too many documents to fit in the window.
- 3 Click the Show List icon to list all open documents. This is useful when you have a large number of documents open and documents names on the tabs may be truncated.

## Working with Multiple Documents in Tiled View

When multiple documents are open, you can view thumbnails of the documents in the work area. To change the view:

- Click **Window > Show Documents in Tiles**.

Open documents are shown as thumbnails in the work area, and the scroll bar becomes active.

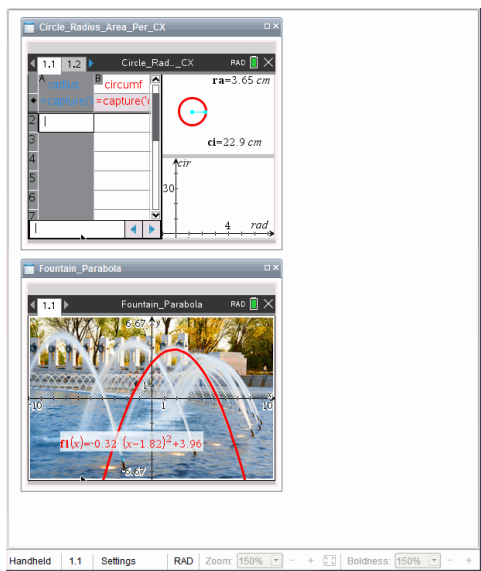



The status bar remains available; however, document names now appear in the thumbnail view. Click **Select Window > Show Documents in Tabs** to view one document at a time in the work area.

## Working with Applications

When you first open a new document or add a new problem to a document, you select an application from a menu.

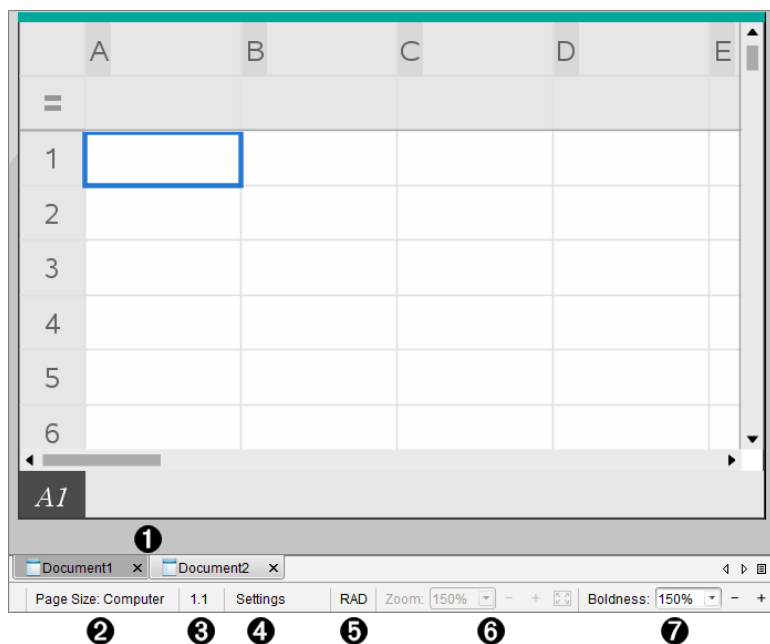
The following illustration shows how a document containing the Lists & Spreadsheet application appears in the work area.



- 1 Document name.** Tabs show the names of open documents. Click a name to make it the active document.
- 2 Page Size.** Shows the document's page size as Handheld or Computer. You can use the TI-Nspire™ **File** menu to convert a document from one page size to the other.
- 3 Problem/Page counter.** Labels the problem number and page number of the active page. For example, a label of **1.2** identifies Problem 1, Page 2.
- 4 Settings.** Double-click to view or change the Document Settings for the active document or to change the default Document Settings.
- 5 Angle Mode.** Shows an abbreviation of the angle mode (Degrees, Radians or Gradians) in effect. Hover the pointer over the indicator to see the full name.
- 6 Zoom.** Enabled in Handheld preview only (click **Document Preview** on the toolbar and select **Handheld**). Click ▼ and select a magnification value, or click the zoom-to-fit button  to make the preview adapt automatically to window size.
- 7 Boldness.** Enabled in Computer preview only (click **Document Preview** on the toolbar and select **Computer**). Click ▼ and select a value to increase or decrease the boldness of text and other items.

## Working with Multiple Applications on a Page

You can add up to four applications to a page. When you have multiple applications on a page, the menu for the active application is displayed in the Documents Toolbox. Using multiple applications involves two steps:

- Changing the page layout to accommodate multiple applications.
- Adding the applications.

You can add multiple applications to a page even if an application is already active.

### Adding Multiple Applications to a Page

By default, each page contains space to add one application. To add additional applications to the page, complete the following steps.

1. Click **Edit > Page Layout > Select Layout**.

—or—

Click  .

The page layout menu opens.



There are eight page layout options available. If an option is already selected, it is dimmed.

2. Highlight the layout you want to add to the problem or page, then click to select it.

The new layout is displayed with the first application active.



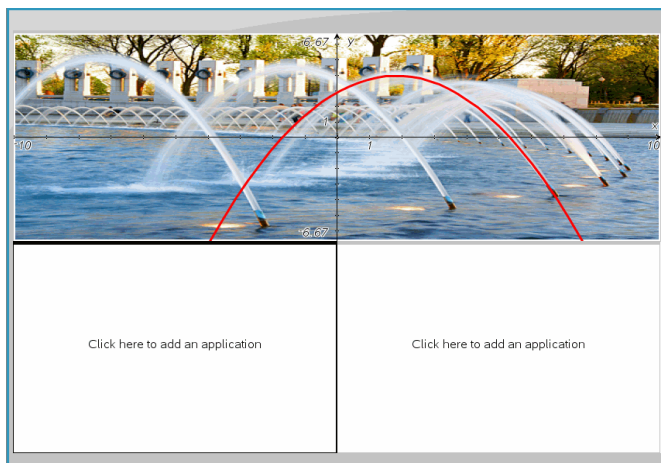

3. In Handheld preview, click **Press menu** to select an application for each new section in the problem or page. In Computer view, select **Click here to add an application**.

### Swapping Applications

To change the position of applications on a page with multiple applications, “swap” the positions of two applications.

1. Click **Edit > Page Layout > Swap Application**.

**Note:** The last active application you worked on is automatically selected as the first application to be swapped.

2. Click the second application to swap.

This action performs the swap.

**Note:** When there are only two work areas, the selected application automatically swaps position with the other application in the work area.

To cancel a swap, press **Esc**.

### Selecting and Moving Pages

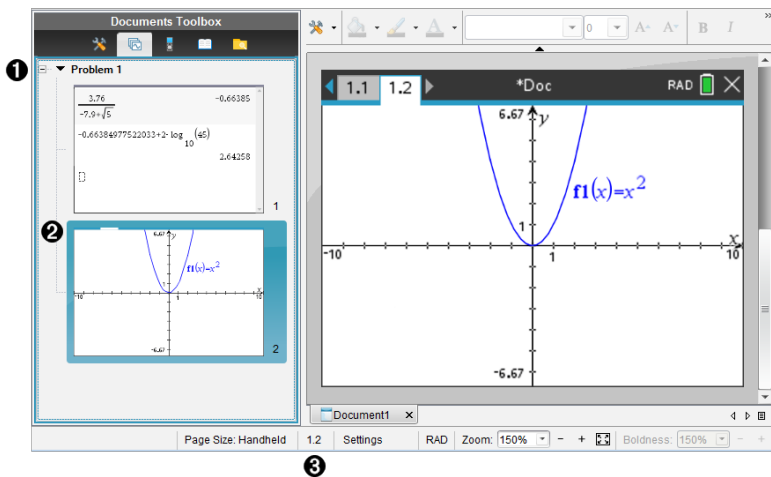

As you add problems and pages to a document, you can take advantage of features for managing the parts.



- ❶ **Page Sorter.** Lists the problems you have inserted in your document and shows thumbnail images of the pages in each problem. The Page Sorter lets you rearrange, copy and move both problems and pages. It also lets you rename problems.
- ❷ **Active page.** Indicates the current page by highlighting its thumbnail image. Thumbnails let you easily scan the pages in a document and select a specific page to work with.
- ❸ **Problem/Page counter.** Displays the problem number and page number of the currently selected page.

## Selecting Pages

Use any of these methods to move from page to page.

- ▶ On the **View** menu, select **Previous Page** or **Next Page**.
- ▶ On the keyboard, press **Ctrl+PgUp** or **Ctrl+PgDn**. (Mac®: Press **Fn+Up Arrow** or **Fn+Down Arrow**).
- ▶ Click the Previous Page  or Next Page  button on the main toolbar.
- ▶ Click the Page Sorter tool  in the Documents Toolbox, and then click the thumbnail of the page you want to work with.

**Tip:** To expand or collapse the list of thumbnails for a problem, double-click the name of the problem.

## Rearranging Pages with the Page Sorter

The Page Sorter makes it easy to reorder pages within a problem.

1. If necessary, click the Page Sorter tool  in the Documents Toolbox.
2. In the Page Sorter, drag the thumbnail image of the page to the desired position.

### **Copying a Page**

You can copy a page within the same problem or copy it to a different problem or document.

1. If necessary, click the Page Sorter tool  in the Documents Toolbox.
2. Select the thumbnail of the page to be copied.
3. On the **Edit** menu, click **Copy**.
4. Click the location at which you want to insert the copy.
5. On the **Edit** menu, click **Paste**.

### **Moving a Page**

You can move a page within the same problem or move it to a different problem or document.

1. If necessary, click the Page Sorter tool  in the Documents Toolbox.
2. Select the thumbnail of the page to be moved.
3. On the **Edit** menu, click **Cut**.
4. Click the new location of the page.
5. On the **Edit** menu, click **Paste**.

### **Deleting a Page**

1. Select the page in the work area or in the Page Sorter.
2. Click **Edit > Delete**.

### **Grouping Applications on a Page**

You can combine as many as four consecutive application pages into a single page.

1. Select the first page in the series.
2. Click **Edit > Page Layout > Group**.

The next page is grouped with the first page. The page layout automatically adjusts to display all the pages in the group.

## Ungrouping Applications into Separate Pages

1. Select the grouped page.
2. Click **Edit > Page Layout > Ungroup**.

The applications are divided into individual pages.

## Deleting an Application from a Page

1. Click the application to be deleted.
2. Click **Edit > Page Layout > Delete Application**.

**Tip:** To undo the delete, press **Ctrl + Z** (Mac®: **⌘ + Z**).

## Working with Problems and Pages

When you create a new document, it consists of a single problem with a single page. You can insert new problems and add pages to each problem.

### Adding a Problem to a Document

A document can contain up to 30 problems. Each problem's variables are unaffected by the variables in other problems.

- ▶ On the **Insert** menu, select **Problem**.

—or—

Click the Insert tool  on the main toolbar, and select **Problem**.

A new problem with an empty page is added to your document.

### Adding a Page to the Current Problem

Each problem can contain up to 50 pages. Each page has a work area, where you can perform calculations, create graphs, collect and plot data, or add notes and instructions.

1. Click **Insert > Page**.

—or—

Click the Insert tool  on the main toolbar, and select **Page**.

An empty page is added to the current problem, and you are prompted to choose an application for the page.

2. Select an application to add to the page.

## Renaming a Problem

New problems are named automatically as Problem 1, Problem 2, and so on. To rename a problem:

1. If necessary, click the Page Sorter tool  in the Documents Toolbox.
2. Click the problem name to select it.
3. On the **Edit** menu, click **Rename**.
4. Type the new name.

## Rearranging Problems with the Page Sorter

The Page Sorter lets you reorder problems within a document. If you move a problem that you have not renamed, the numeric part of the default name changes to reflect the new position.

1. If necessary, click the Page Sorter tool  in the Documents Toolbox.
2. In the Page Sorter, arrange the problems by dragging each problem name to its new position.

**Tip:** To collapse a problem's list of page thumbnails, double-click the name of the problem.

## Copying a Problem

You can copy a problem within the same document or copy it to a different document.

1. If necessary, click the Page Sorter tool  in the Documents Toolbox.
2. Click the problem name to select it.
3. On the **Edit** menu, click **Copy**.
4. Click the location at which you want to insert the copy.
5. On the **Edit** menu, click **Paste**.

## Moving a Problem

You can move a problem within the same document or move it to a different document.

1. If necessary, click the Page Sorter tool  in the Documents Toolbox.
2. Click the problem name to select it.
3. On the **Edit** menu, click **Cut**.

4. Click the new location of the problem.
5. On the **Edit** menu, click **Paste**.

### **Deleting a Problem**

To delete a problem and its pages from the document:

1. If necessary, click the Page Sorter tool  in the Documents Toolbox.
2. Click the problem name to select it.
3. On the **Edit** menu, click **Delete**.

### **Printing Documents**

1. Click **File > Print**.

The Print dialogue box opens.

2. Set options for the print job.
  - **Printer** — Select from your list of available printers
  - **Print What:**
    - **Print All** — prints each page on a separate sheet
    - **Viewable Screen** — prints selected pages with additional layout options (see **Layout**, below)
  - **Print Range** — Click **All Pages**, or click **Page range** and set the starting and ending pages.
  - **Layout:**
    - **Orientation** (portrait or landscape)
    - The number of TI-Nspire™ pages (1, 2, 4 or 8) to be printed on each sheet (available in **Viewable Screen** option only). The default is 2 pages per sheet.
    - Whether to allow space below each printed TI-Nspire™ page for comments (available in **Viewable Screen** option only)
    - **Margins** (from .25 inches to 2 inches) The default margin is .5 inches on all edges.
  - **Documentation information to include:**
    - **Problem name**, including the option to group the pages physically by problem
    - **Page label** (such as 1.1 or 1.2) under each page
    - **Page header** (up to two lines)
    - **Document name** in the footer
3. Click **Print**, or click **Save As PDF**.

**Note:** To restore the Print defaults, click **Reset**.

## Using Print Preview

- Click the **Preview** tickbox to toggle the preview pane.
- Click the arrows at the bottom of the preview pane to page through the preview.

## Viewing Document Properties and Copyright Information

**Note:** Most of these instructions apply only to the Teacher Software.

### Checking Page Size

1. In the Teacher Software, go to the TI-Nspire™ **File** menu and select **Document Properties**.
2. Click the **Page Size** tab.
3. A tick indicates the document's current page size.

### Viewing Copyright Information

The Teacher Software and Student Software let you view copyright information that has been added to a document.

1. On the TI-Nspire™ **File** menu, select **View Copyright Information**.

The Copyright Information dialogue box opens.

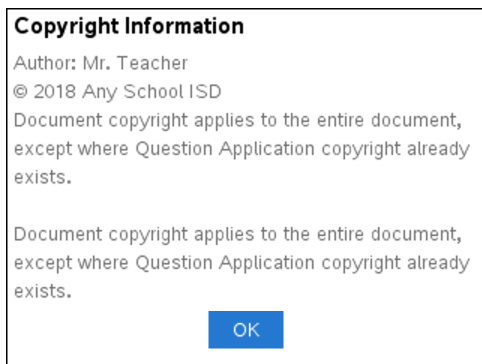

2. Click **OK** to close the dialogue box.

### Adding Copyright Information to a Document

Using the Teacher Software, you can add copyright information to individual documents that you create, or you can apply the same copyright information to all new documents.

1. Open the document.

2. On the TI-Nspire™ **File** menu, select **Document Properties**.
3. Click the **Copyright** tab.
4. Edit the following fields to define the copyright details:
  - Author
  - Copyright (select Public Domain or Copyright).
  - Year (disabled if you selected Public Domain)
  - Owner (disabled if you selected Public Domain)
  - Comments
5. To add the supplied information to all new documents from this point forward, select **Apply this copyright to all new documents**.
6. Click **OK** to apply the copyright information to the document.

### **Protecting a Document (making a document read-only)**

Teachers can protect documents to create a document for distribution to your students or for other use. A student who receives a read-only document and makes changes to it will be prompted to save the document as a new file.

1. Open the document.
2. On the TI-Nspire™ **File** menu, select **Document Properties**.
3. Click the **Protection** tab.
4. Select the **Make this document Read Only** checkbox.
5. Click **OK**.



## Working with Lesson Bundles

Many lessons or activities contain multiple files. For example, teachers usually have a teacher version of a file, a student version, assessments and sometimes supporting files. A lesson bundle is a container that enables teachers to group all files needed for a lesson together. Lesson bundles are used to:



- Add any type of file (.tns, .doc, .pdf, .ppt) to a lesson bundle.
- Send lesson bundles to connected handhelds or laptops; however, only the .tns files are sent to the handheld.
- View all the files in a lesson bundle using the TI-Nspire™ software.
- Group all files associated with one lesson in one place.
- Email one lesson bundle file to teachers or students instead of looking for and attaching multiple files.

### ***Creating a New Lesson Bundle***

Teachers and students can create new lesson bundles in the Documents Workspace. Teachers can also create new lesson bundles in the Content Workspace.

#### **Creating a Lesson Bundle in the Documents Workspace**

Complete the following steps to create a new lesson bundle. By default, the new lesson bundle does not contain files.

1. Click  in the Documents Toolbox to open the Content Explorer.
2. Navigate to the folder where you want to save the lesson bundle file.
3. Click  to open the menu, and then click **New Lesson Bundle**.

The new lesson bundle file is created with a default name and placed in your list of files.

4. Type a name for your lesson bundle.
5. Press **Enter** to save the file.

#### **Creating Lesson Bundles in the Content Workspace**

In the Content Workspace, teachers have two options for creating lesson bundles:

- When files needed for a lesson bundle are located in different folders, create an empty lesson bundle and then add files to the lesson bundle.
- If all needed files are located in the same folder, create a lesson bundle with selected files.

### ***Creating an Empty Lesson Bundle***

Complete the following steps to create a lesson bundle that does not contain files.

1. Navigate to the folder on your computer where you want to save the lesson bundle.

**Note:** If you are using the software for the first time, you may need to create a folder on your computer before creating a lesson bundle.

2. Click  or click **File > New Lesson Bundle**.

The new lesson bundle file is created with a default name and placed in the list of files.

3. Type a name for the lesson bundle and press **Enter**.

The lesson bundle is saved with the new name and details are shown in the Preview pane.

### ***Creating a Lesson Bundle Containing Files***

You can select multiple files within a folder, and then create the lesson bundle. You cannot add a folder to a lesson bundle.

1. Navigate to the folder that contains the files you want to bundle.
2. Select the files. To select multiple files, select the first file then hold down **Shift** and click the last file in the list. To select random files, select the first file and then hold down **Ctrl** and click the other files to select them.

3. Click , and then click **Lesson Bundles > Create New Lesson Bundle from selected**.

A new lesson bundle is created and placed in the open folder. The lesson bundle contains copies of the selected files.

4. Type a name for the lesson bundle and press **Enter**.

The lesson bundle is saved in the open folder and the details are shown in the Preview pane.

### ***Adding Files to a Lesson Bundle***

Use any of the following methods to add files to a lesson bundle:

- Drag any file into a selected lesson bundle. This method moves the file to the lesson bundle. If you delete the lesson bundle, the file is deleted from your computer. You can recover the file from the Recycle Bin.
- Copy and paste any file into a selected lesson bundle.
- Use the “Add files to lesson bundle” option. This method copies the selected files into the lesson bundle. The file is not moved from its original location.

### **Using the Add Files to Lesson Bundle Option**

Use this option to add files to an empty lesson bundle or add more files to an existing lesson bundle.

1. Use one of the following options to select the lesson bundle file.
  - When working in the Documents Workspace, open the Content Explorer and then double-click the lesson bundle file name.

- When working in the Content Workspace, double-click the lesson bundle name.

**Note:** In the Content Workspace, you can also click the lesson bundle name to open the Files dialogue box in the Preview pane. The Add Files to Lesson Bundle option is available from the Files dialogue box. If the lesson bundle already contains files, the first file in bundle is shown in the Files dialogue box.

The lesson bundle dialogue box opens. The name reflects the name of the lesson bundle.

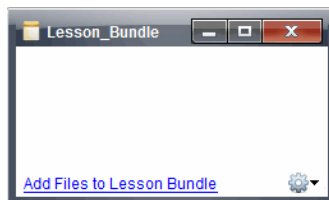

2. Click **Add Files to Lesson Bundle**.

The Add dialogue box opens.

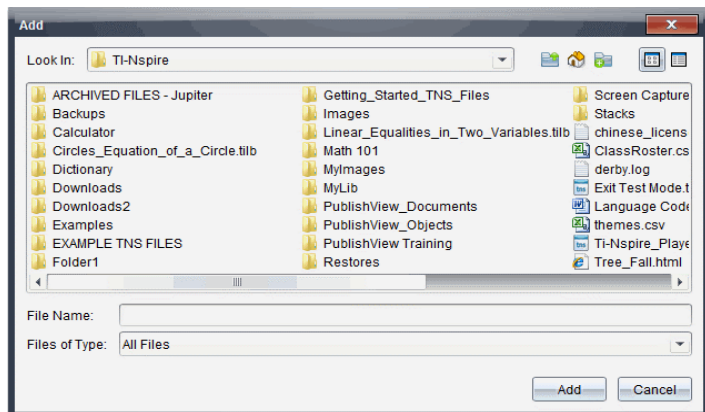

3. Navigate to and select the file you want to add to the lesson bundle.
  - You can select multiple files at one time if they are located in the same folder.
  - If files are located in different folders, you can add them one at a time.
  - You cannot create a folder within a lesson bundle or add a folder to a lesson bundle.
4. Click **Add** to add the file to the bundle.

The file is added to the bundle and is now listed in the lesson bundle dialogue box.
5. Repeat this process until all needed files are added to the lesson bundle.

## Opening a Lesson Bundle

To view and work with files within a lesson bundle, complete one of the following steps to open the lesson bundle file.

- ▶ Double-click the lesson bundle name.
- ▶ Select the lesson bundle, and then right-click and click **Open**.
- ▶ Select the lesson bundle, click , and then click **Open**.
- ▶ Select the lesson bundle, and then press Ctrl + O. (Mac®: ⌘ + O).

When you open a lesson bundle, the files in the bundle are displayed in a separate dialogue box.

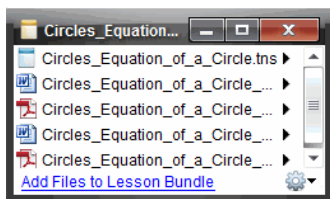

**Note:** You cannot open a lesson bundle outside of the TI-Nspire™ software. For example, if you open the folder using the file manager on your computer and double-click the lesson bundle name, it does not automatically launch the TI-Nspire™ software.

## Opening Files Within a Lesson Bundle

You can open any file within a lesson bundle on your computer if you have the programme associated with the file type.

- When you open a .tns file, the file opens in the Documents Workspace in the TI-Nspire™ software.
- When you open another file type, it launches the application or programme associated with that file. For example, if you open a .doc file, it opens in Microsoft® Word.

Use one of the following options to open a file within a lesson bundle:

- ▶ Double-click the lesson bundle, and then double-click a file within the lesson bundle.
- ▶ Within a lesson bundle, select the file and then click ▶ or right-click the file name and select **Open**.

## Managing Files in a Lesson Bundle

You can open, copy/paste, delete and rename files in an existing lesson bundle. To locate and work with files in an existing lesson bundle:

1. Choose one of the following options to locate an existing lesson bundle.

- When working in the Documents Workspace, open the Content Explorer (click  in the Documents Toolbox), and then navigate to the folder where the lesson bundle is located.
- When working in the Content Workspace, navigate to the folder where the lesson bundle is located in Content pane.

**Note:** When you click a lesson bundle name in the Content pane, the Files dialogue box opens in the Preview pane. Select a file and right-click to open the context menu.

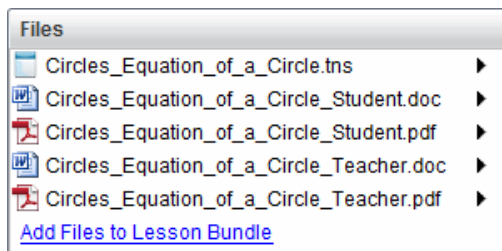

2. Double-click the lesson bundle name to open the Lesson Bundle dialogue box.

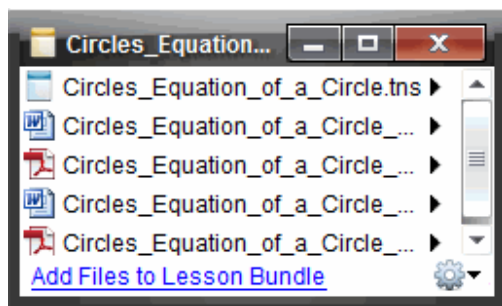

3. Select the file you want to work with and click  to open the context menu.

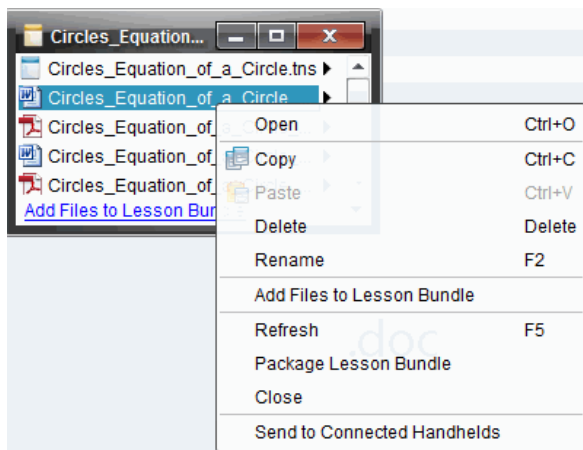

4. Click the action you want to perform:

- Click **Open**. TI-Nspire™ documents open in the Documents Workspace. When you open another file type, it launches the application or programme associated with that file.
- Click **Copy** to place the file in the Clipboard.
- Navigate to a folder on your computer or select a connected handheld or laptop, and then right-click and click **Paste** to place the copied file in a new location.
- Click **Delete** to delete a file from the lesson bundle. Use caution when deleting a file from a lesson bundle. You should ensure files contained in the bundle are backed up if you need the files for future use.
- Click **Rename** to give the file a new name. To cancel this action, press **Esc**.
- Click **Add Files to Lesson Bundle** to select and add files to the bundle.
- Click **Refresh** to update the list of files in the bundle.
- Click **Package Lesson Bundle** to create a .tilb file
- Click **Send to Connected Handhelds** to open the Transfer Tool and send the selected file to connected handhelds. You can send .tns files and OS files.

5. When finished, click **Close** to close the dialogue box.

## ***Managing Lesson Bundles***

Use the options menu or the context menu to copy, delete, rename or send a lesson bundle to connected handhelds or laptops. You cannot add a folder to a lesson bundle.

### **Managing Lesson Bundles in the Documents Workspace**



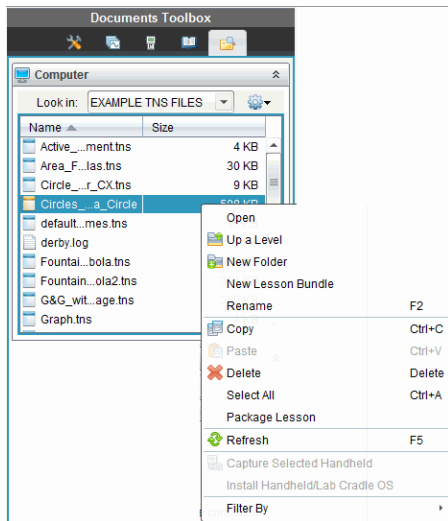

1. Open the Content Explorer, and then right-click the lesson bundle name or click  to open the context menu.



2. Click the action you want to perform. If an action is not available, it is dimmed.
  - Click **Open** to open the lesson bundle.
  - Click **Up One Level** to navigate up a level in the folder hierarchy.
  - You cannot add a folder to a lesson bundle. If you click **New Folder**, a new folder is added to the folder where the lesson bundle is stored.
  - Click **New Lesson Bundle** to create a new lesson bundle. The new lesson bundle is not added to the existing lesson bundle—it is created in the same folder as the existing lesson bundle.
  - Click **Rename** to change the name of the lesson bundle. Press **Esc** to cancel this action.
  - Click **Copy** to copy the lesson bundle to the Clipboard.
  - Navigate to another folder, and then click **Paste** to copy the lesson bundle in another location.
  - Click **Delete** to delete the lesson bundle. Use caution when deleting a lesson bundle. You should ensure files contained in the bundle are backed up if you need the files for future use.
  - **Select All** highlights all files in the open folder. This action does not apply to lesson bundles.
  - Click **Package Lesson** to create a .tilb file.
  - Click **Refresh** to update the list of files in the open folder.

### Managing Lesson Bundles in the Content Workspace

1. Click **Local Content** in the Resources pane.
2. In the Content pane, navigate to the lesson bundle you want to work with, and then right-click to open the context menu or click  to open the menu of options.

Open	Ctrl+O
 Copy	Ctrl+C
 Paste	Ctrl+V
 Delete	Delete
Refresh	Ctrl+R
Rename	F2
 Up a Level	Alt+Up
 New Folder	Ctrl+Shift+N
Create Shortcut...	
Lesson Bundles	▶
Send to Connected Handhelds	
Filter by	▶

### 3. Select the action you want to perform:

- Click **Open** to open the lesson bundle.
- Click **Copy** to place the lesson bundle file in the Clipboard.
- Navigate to a folder on your computer or select a connected handheld, and then right-click and click **Paste** to place the copied file in a new location.
- Click **Delete** to delete the lesson bundle. Use caution when deleting a lesson bundle. You should ensure files contained in the bundle are backed up if you need the files for future use.
- Click **Refresh** to update the list of files in the bundle.
- Click **Rename** to give the lesson bundle a new name. To cancel this action, press **Esc**.
- To move up a level in the folder hierarchy, click **Up a Level**.
- To add the lesson bundle to the list of shortcuts in Local Content, click **Create Shortcut**.
- To add more files to the lesson bundle, click **Lesson Bundles > Add Files to Lesson Bundle**.
- Click **Lesson Bundles > Package Lesson Bundle** to create a .tilb file.
- Click **Send to Connected Handhelds** to open Transfer Tool and send the lesson bundle to connected handhelds.

## Packaging Lesson Bundles

Packaging lesson bundles creates a “package” folder with a .tilb file. This file contains all files contained in the lesson bundle. You must package the lesson before you can email the lesson bundle (.tilb file) to colleagues or students. By default, the lesson bundle is saved in the following folder:

...\\TI-Nspire\\New Lesson Bundle1.tilb\\package\\...

### Packaging a Lesson in the Documents Workspace

1. Open the Content Explorer.
2. Navigate to the folder where the lesson bundle is saved.



3. Select the lesson bundle you want to package.
4. Right-click to open the context menu, and then click **Package Lesson**.

The Lesson Bundle dialogue box opens confirming that the .tilb file was created and the lesson bundle was successfully packaged.

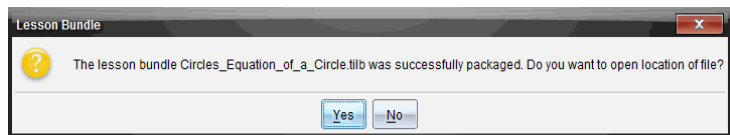

5. Click **Yes** to open the folder where the lesson package is stored. Click **No** to close the dialogue box.

### **Packaging a Lesson in the Contents Workspace**

1. In **Computer Content**, navigate to the folder that contains the lesson bundle you want to package.
2. Click the lesson bundle in the Content pane. The Lesson Bundle details are displayed in the Preview pane.
3. Use one of the following methods to create the package:
  - From the Preview pane, click ► in the Files dialogue box, and then click **Package Lesson Bundle**.
  - From the Content pane, right-click the lesson bundle name, and then click **Lesson Bundles > Package Lesson Bundle**.

The Lesson Bundle dialogue box opens confirming that the lesson bundle was created.

4. Click **Yes** to open the folder where the lesson package is stored. Click **No** to close the dialogue box.

### ***Emailing a Lesson Bundle***

After a lesson bundle is packaged, you can email the .tilb file to other teachers or students. To attach the lesson bundle to an email:

1. In your email client, select the option needed to attach a file, and then navigate to the .tilb folder.
2. Make sure you open the folder and select the .tilb file to attach to the email. You cannot email the .tilb folder.

### ***Sending Lesson Bundles to Connected Handhelds***

1. Complete one of the following actions to select a lesson bundle:
  - In the Documents Workspace, open the Content Explorer, and then select the lesson bundle you want to send.
  - In the Content Workspace, navigate to the lesson you want to send in the Content pane.

2. Drag the lesson bundle file to a connected handheld. You can also copy the lesson bundle, and then paste it to a connected handheld.

The lesson bundle is transferred to the handheld as a folder with the same name. Only .tns files are transferred to the handheld.

# Capturing Screens

Screen Capture enables you to:

- **Capture Page**
  - Capture the active page in a TI-Nspire™ document from the software or from the TI-SmartView™ emulator as an image.
  - Save captured images as .jpg, .gif, .png or .tif files, which can be inserted into TI-Nspire™ applications that allow images.
  - Copy and paste images into another application such as Microsoft® Word.
- **Capture Selected Handheld**
  - Capture the current screen on a connected handheld as an image.
  - Save captured images as .jpg, .gif, .png or .tif files, which can be inserted into TI-Nspire™ applications that allow images.
  - Copy and paste images into another application such as Microsoft® Word.
- **Capturing Images in Handheld Mode**
  - In the Documents Workspace, use the DragScreen feature to capture the emulator screen or side screen when the TI-SmartView™ Emulator is active.
  - Teachers can use this feature to drag and paste an image to presentation tools such as SMART® Notebook, Promethean's Flipchart and Microsoft® Office applications including Word and PowerPoint®.

For web-based connectivity using your TI-Nspire™ CX II with a Chromebook, Windows® computer, or Mac® computer, go to [TI-Nspire™ CX II Connect](#).

## Accessing Screen Capture

The Screen Capture tool is available from all workspaces. To access Screen Capture:

- ▶ From the menu bar, click **Tools > Screen Capture**.
- ▶ From the toolbar, click .

## Using Capture Page

Use the Capture Page option to capture an image of an active page in a TI-Nspire™ document. You can save images in the following file formats: .jpg, .gif, .png and .tif. Saved images can be inserted into TI-Nspire™ applications that allow images. The image is also copied to the Clipboard and can be pasted into other applications such as Microsoft® Word or PowerPoint®.

### Capturing a Page

Complete the following steps to capture an image of an active page.

1. In the Documents Workspace, open a document and navigate to the page you want to capture to make it active.

2. Click , and then click **Capture Page**.

The image of the active page is copied to the Clipboard and to the Screen Capture

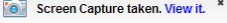
window. The  dialogue box opens in the lower right corner of your desktop when the screen capture is complete.

3. Click **View it**.

The Screen Capture window opens.

You can also click **Window > Screen Capture Window** to open the Screen Capture window.

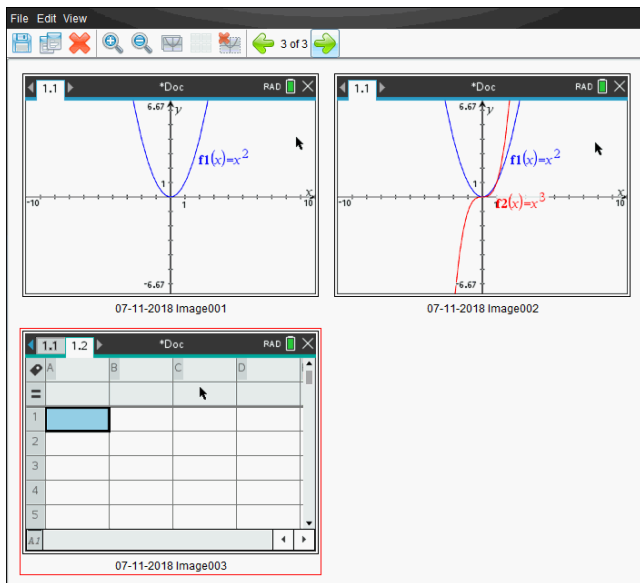

4. To capture additional pages, move to another page in the current document or open a new document to select a page.

As you capture additional pages, the images are copied to the Screen Capture window, which holds multiple images. The last page captured replaces the contents of the Clipboard.

## Using Capture Selected Handheld

Use the Capture Selected Handheld option to capture the active screen on a connected handheld.

1. On a connected handheld, navigate to the menu or to a page in a document you want to capture.
2. In the software, select the connected handheld:

- In the Content Workspace, select the handheld from the list of Connected Handhelds in the Resources pane.
- In the Documents Workspace, open Content Explorer from the Documents Toolbox, and then select the handheld from the list of Connected Handhelds.
- In the Class Workspace, select a logged in student.

3. Click , and then click **Capture Selected Handheld**.

—or—

Click , and then click **Capture Selected Handheld**.

The screen is copied to the Clipboard and to the TI-Nspire™ Screen Capture

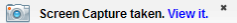
window. The  dialogue box opens in the lower right corner of your desktop when the screen capture is complete.

4. Click **View it**.

The Screen Capture window opens.

You can capture additional screens from an open document on a connected handheld or open another document on a connected handheld to capture screens from that document.

As you capture additional screens, the images are copied to the Screen Capture window, which holds multiple images. The last screen captured replaces the contents of the Clipboard.

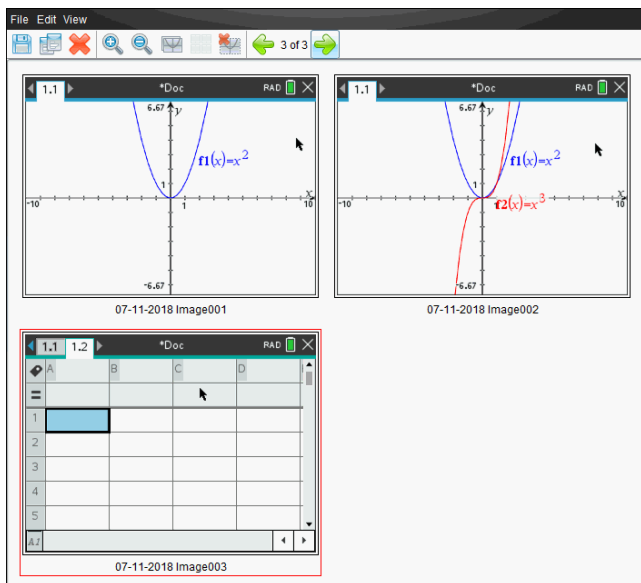

## ***Viewing Captured Screens***

When you capture a page or screen, it is copied to the Screen Capture window.



## Zooming the View of Captured Screens

In the Screen Capture window, use the zoom in and zoom out options to increase or decrease the size of the captured screens.

- ▶ From the toolbar, click  to increase the size of the screens in the view. You can also click **View > Zoom In** from the menu.
- ▶ From the toolbar, click  to decrease the size of the screens in the view. You can also click **View > Zoom Out** from the menu.

## Saving Captured Pages and Screens

You can save captured pages and screens captured as images for use in other TI-Nspire™ documents that allow images or for use in other applications such as Microsoft® Word. You can save one image at a time, select multiple images to save or save all captured images.

### Saving Selected Screens

1. In the Screen Capture window, select the screen image you want to save.
2. Click **File > Save Selected Screen(s)**.

**Note:** From the Screen Capture window, you can also click .

The Save as dialog box opens.

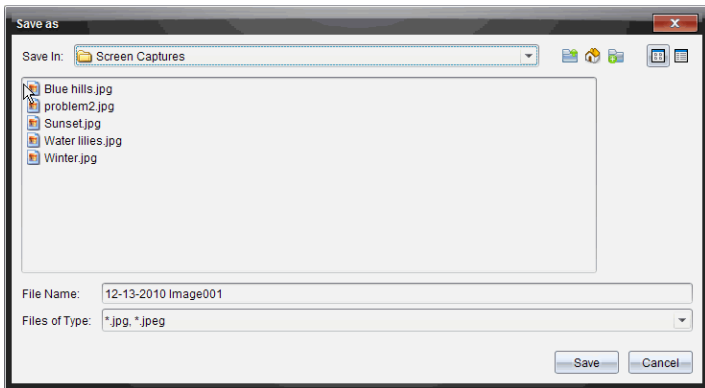

3. Navigate to the folder on your computer where you want to save the file.
4. Type a name for the file.

**Note:** The default file name is *MM-DD-YYYY Image ###*.

5. Select the file type for the image file. The default format is .jpg. Click ▼ to select another format: .gif, .tif or .png.
6. Click **Save**.

The file is saved in the designated folder.

### Saving Multiple Screens

1. In the Screen Capture window, select the screens you want to save.

To select multiple consecutive screens, click the first image, and then hold down the **Shift** key and click the additional images. To select screens in random order, press **Ctrl** (Mac®: **⌘**) and click each image you want to save.

2. Click  or select **File > Save Selected Screen(s)**. To save all captured screens, select **File > Save All Screens**.

**Note:** The "Save All Screens" option is not available when using Capture Class.

The Save as dialogue box opens.

3. In the Save In field, navigate to the folder where you want to save the images.
4. In the File Name field, type a new folder name. The default folder name is *MM-DD-YYYY Image*, where *MM-DD-YYYY* is the current date.
5. Select the file type for the image files. The default format is .jpg. Click ▼ to select another format: .gif, .tif, or .png.
6. Click **Save**.

The images are saved in the specified folder with system-assigned names reflecting the current date and a sequence number. For example, *MM-DD-YYYY Image 001.jpg*, *MM-DD-YYYY Image 002.jpg* and so on.

## ***Copying and Pasting a Screen***

You can select a captured screen and copy it to the Clipboard for inclusion into other documents or applications. You can also print copied screens. Copied screens are captured at 100% zoom level, and they are copied in the order of selection.

### **Copying a Screen**

1. Select the screen to copy.
2. Click  or **Edit > Copy**.

The selected screen is copied to the Clipboard.

### **Pasting a Screen**

Depending on the application you are pasting to, click **Edit > Paste**.

**Note:** You can also drag a screen capture to another application. This functions as a copy and paste.

## ***Capturing Images in Handheld Mode***

In the Documents Workspace, use the DragScreen feature to capture the emulator screen or side screen when the TI-SmartView™ Emulator is active.

Teachers can use this feature to drag and paste an image to presentation tools such as SMART® Notebook, Promethean's Flipchart and Microsoft® Office applications including Word and PowerPoint®.

### **Capturing Images Using the DragScreen Feature**

Complete the following steps to capture an image and copy it to a third-party application.

1. From the Documents Workspace, click , which is located in the Documents Toolbox.

The TI-SmartView™ Emulator opens.

- If the display selected is **Handheld + SideScreen**, the current document is shown in the emulator and in the side screen.
- If the display selected is **Keypad + SideScreen**, the current document is shown in the side screen.



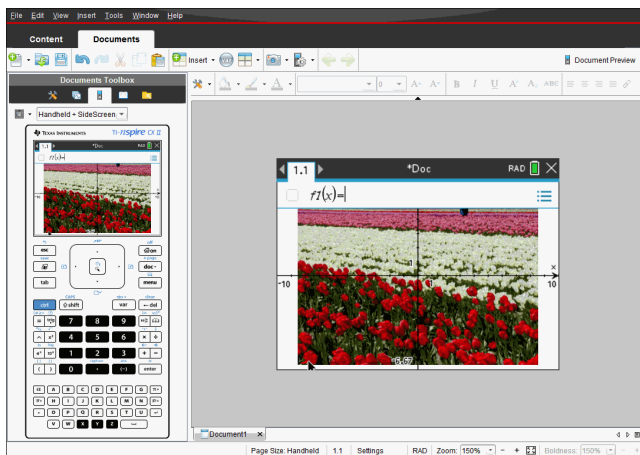

- To start the screen capture, click the area above the emulator screen or above the keypad. In the **Handheld + SideScreen** display, you can also click the area around the emulator screen.

Do not release the mouse button. If the cursor is active or if you click inside the emulator window, the screen capture is not started.

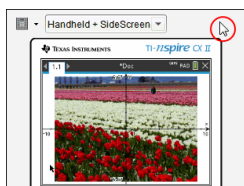

In Handheld + SideScreen view, click the area above the emulator, click the area around the emulator or click the border of the emulator screen to start the screen capture.

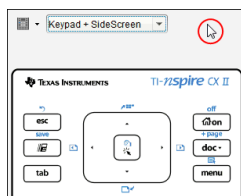



In Keypad + SideScreen view, click the area above the keypad to start the screen capture.

- Without releasing the mouse, drag the image.

A ghost image of the captured screen opens. The ghost image remains visible until you release the mouse button.

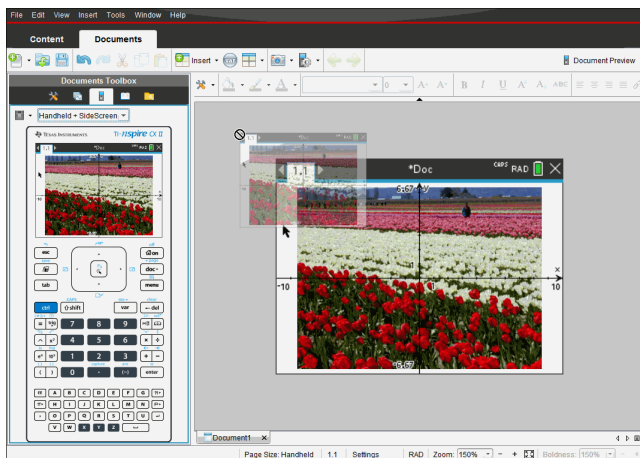
The  in the corner of the ghost image indicates you cannot paste the image in that location.



4. Drag the image to an open third-party application. When the image is on top of the third-party application, the  indicates you can drop the image.
5. Release the mouse button to drop the image into the selected application.

The image is also copied to the Clipboard and to the TI-Nspire™ Screen Capture window.

To view captured images in the Screen Capture window, click **Window > Screen Capture Window**.

You can capture additional screens as needed. As you capture additional screens, the images are copied to the Screen Capture window, which holds multiple images. The last screen captured replaces the contents of the Clipboard.

## Working with Images

Images can be used in TI-Nspire™ applications for reference, assessment and instructional purposes. You can add images to the following TI-Nspire™ applications:

- Graphs & Geometry
- Data & Statistics
- Notes
- Question, including Quick Poll

In the Graphs & Geometry and Data & Statistics applications, images are set in the background behind the axis and other objects. In the Notes and Question applications, the image is set at the cursor location in-line with the text (in the foreground).

You can insert the following image file types: .jpg, .png or .bmp.

**Note:** The transparency feature of a .png file type is not supported. Transparent backgrounds are displayed as white.

### *Working with Images in the Software*

When working in the TI-Nspire™ software, you can insert, copy, move and delete images.

#### **Inserting Images**

In the Notes and Question applications, and in Quick Poll, you can insert more than one image on a page. You can only insert one image on a page in the Graphs & Geometry and Data & Statistics applications.

1. Open the document where you want to add an image.
2. Click **Insert > Image**.

The Insert Image dialogue box opens.

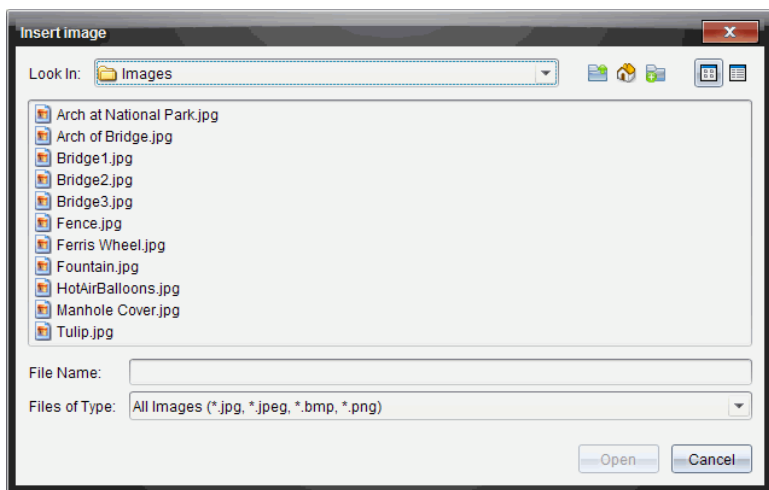



3. Navigate to the folder where the image is located and select the image.
4. Click **Open**.
  - In the Graphs & Geometry and Data & Statistics applications, the image is inserted in the background behind the axis.
  - In Notes, Question and Quick Poll, the image is inserted at the cursor location. You can type text above or below the image, and you can move the image up or down on the page.

**Note:** You can also insert images by copying an image to the Clipboard and pasting it into the application.

### Moving Images

In applications such as Notes and Question where the image is set at the cursor location, you can reposition the image by moving the image to a new line or blank space, or by placing the image within a line of text. In the Graphs & Geometry and Data & Statistics applications, images can be moved to any position on the page.

1. Select the image.
  - In the Notes and Question applications, click the image to select it.
  - In the Graphs & Geometry and Data & Statistics applications, right-click the image and then click **Select > Image**.
2. Click the selected image and hold the mouse button.
  - If an image is in the foreground, the cursor changes to  .
  - If an image is in the background, the cursor changes to  .

3. Drag the image to the new location and release the mouse button to place the image.

If an image is in the foreground, the cursor changes to  when you hover your mouse pointer over a location where there is a new line or space. Images in the background can be moved and placed anywhere on the page.

## Resizing Images

To retain the aspect ratio of an image, resize by grabbing the image at one of the four corners.

1. Select the image.
  - In the Notes and Question applications, click the image to select it.
  - In the Graphs & Geometry and Data & Statistics applications, right-click the image and then click **Select > Image**.
2. Move the cursor to one of the corners of the image.

The cursor changes to  (a four-sided directional arrow).

**Note:** If you drag the cursor to an edge of the image, the cursor changes to  (a two-sided directional arrow). If you drag an image from one of its edges to resize it, the image becomes distorted.

3. Click the corner or edge of the image.

The  tool is enabled.

4. Drag in to make the image smaller or drag out to make the image larger.
5. Release the mouse when the image size is correct.

## Deleting Images

To delete an image from an open document, complete the following steps.

1. Select the image.
  - If an image is in the foreground, click the image to select it.
  - If an image is in the background, right-click the image and then click **Select > Image**.
2. Press **Delete**.

The image is removed.

## Responding to Questions





The teacher may send you a question in a variety of format types. This section shows you how to answer the different question types.

### ***Understanding the Question Toolbar***

When you open a document with a question, a toolbar is available with four options. Access the toolbar using the following method.

- In the Documents Toolbox, click .

Handheld, press .

Tool name		Tool function
	Clear Answers	Lets you clear the answers in the current question or in the document.
	Check Answer	If your document is in Self-Check mode, click here to view the correct answer. You cannot check answers to exam-type questions.
	Insert	Lets you insert an expression box in your answer.
	Format	Click this tool to format the selected text in your answer as subscript or superscript.

### ***Types of Questions***

There are several types of questions you may be asked. There may be variations in a type but how you answer the question is basically the same for each type.

- **Multiple choice**
  - Custom
  - ABCD
  - True/False
  - Yes/No
  - Always/Sometimes/Never
  - Agree/Disagree
  - Strongly Agree...Strongly Disagree
- **Open response**
  - Explanation
  - Text match
- **Equation**

- $y=$
- $f(x)=$
- **Coordinate points and list**
  - (x,y) numerical input
  - Drop point(s)
  - List(s)

## **Responding to Quick Poll Questions**

When teachers send quick polls during class, the question opens as a new document on top of any document you may currently have open. You can access other applications to perform calculations, and check or clear answers before submitting your answer to the question or quick poll.

**Note:** On TI-Nspire™ CX or TI-Nspire™ CX CAS handhelds, questions appear in colour if the teacher applied colour when writing the question. Although you can see colour in the questions you receive, you cannot add colour to the responses you submit.

### **Accessing Other Applications**

If the teacher gives permission, the Quick Poll tool allows you to temporarily exit the question to perform calculations or access other documents to determine the answer to the question. For example, you can access the Scratchpad to perform a calculation, or you can access the Lists & Spreadsheet application and copy data from there to a List question type. In a List question, you can link to variables from the Vernier DataQuest™ or Lists & Spreadsheet applications.

To access other applications while in the Quick Poll screen:

1. Open a new document.

Handheld: Press  to open the **Home** screen.

2. Choose an application.

Handheld: To return to the Quick Poll without accessing any documents, choose **C: Quick Poll**.

3. When you are finished, click the Quick Poll icon.

When you respond to a poll, your response is immediately sent to the teacher's computer and teachers can track student responses in real time.

### **Showing Your Work**

The teacher may request you to show work for your response. If so, the response area has sections for you to write your starting point, your steps, and the final answer.

### **Responding to Different Question Types**

- ▶ For Multiple Choice questions, press **Tab** to navigate to a response. Press **Enter** to mark a response.
- ▶ For Open Response questions, type a response.

- ▶ For Equation questions, type a response. If a graph is included in a question, the graph updates when you press **Enter**. Any functions entered show up on the graph, and the cursor remains in the answer box. You cannot manipulate the graph itself.
- ▶ For Expression questions, type a response. If the response type is Number, your response must be in the form of a number. If the response type is Expression, your response must be in the form of an expression. For example,  $x+1$ .
- ▶ For Coordinate Points: (x,y) questions, type an answer in the x-field box, and press **Tab** to move to the y-field box. Type an answer.

If a graph is included with the question, the graph is updated when you enter a function and press **Enter**.

You can access the Window and Zoom functions while you are working on the graph.

- ▶ For Coordinate Points: Drop Points questions, press **Tab** to move the cursor to a point on the graph. Press **Enter** to drop a point at that location.

To delete a point, press **Ctrl + Z** to undo the action.

- ▶ For Lists questions, press **Tab** if necessary to move the cursor to the first cell of the list. Type an answer, and press **Tab** to move to the next cell. Type an answer.

To link a column to an existing variable, select the column and then click **var**. Click **Link To**, and then click the variable you want to link to.

The behaviour in a Lists question closely matches the behaviour of the Lists & Spreadsheet application, with the following exceptions. In a Lists question, you cannot:

- Add, insert, or delete columns.
- Change the header row.
- Enter formulas.
- Switch to Table.
- Create plots.

- ▶ For Chemistry questions, type a response.
- ▶ For Image: Label questions, press **Tab** to move the cursor to a label on the image. Type a response in the label field.
- ▶ For Image: Point on questions, press **Tab** to move the cursor to a point on the image. Press **Enter** to mark a response.

## Checking Answers

If the teacher enables self-check on the question, the Check Answer option is available.

1. Click .

Handheld: Press menu.



2. Click **Check Answer**.

### **Clearing Answers**

After you answer a quick poll, you may decide you want to change the answer before you submit it.

- ▶ Click **Menu > Clear Answers > Current Question** or **Document**.

- **Current Question** clears answers for the active question.
- **Document** clears answers for all questions contained in the active document.

—or—

If you answered the question, you still have time to clear the answer before you submit it to your teacher.

- ▶ Click **Clear Answer** to clear your answer and try again.

Handheld: Press  and choose **Clear Answer**.

### **Submitting Responses**

To send a final answer to the teacher:

- ▶ Click **Submit Response**.

Handheld: Press  and choose **Submit**.

The response is sent to the teacher and the last screen you used is displayed.

Your response appears on the teacher's computer. Your teacher may have set the poll to allow you to submit more than one answer. If so, you can continue to respond to the poll and submit answers until the teacher stops the poll.

# Calculator Application

The Calculator application lets you:

- Enter and evaluate maths expressions
- Define variables, functions, and programmes that become available to any TI-Nspire™ application—such as the Graphs application—residing in the same problem.
- Define library objects, such as variables, functions, and programmes, which are accessible from any problem of any document. For information on creating library objects, see *Libraries*.

## Adding a Calculator Page

- ▶ To start a new document with a blank Calculator page:

From the main **File** menu, click **New Document**, and then click **Add Calculator**.

Handheld: Press **[on]**, and select **Calculator** **[+]**.

- ▶ To add a Calculator page in the current problem of an existing document:

From the toolbar, click **Insert > Calculator**.

Handheld: Press **[doc]** and select **Insert > Calculator**.

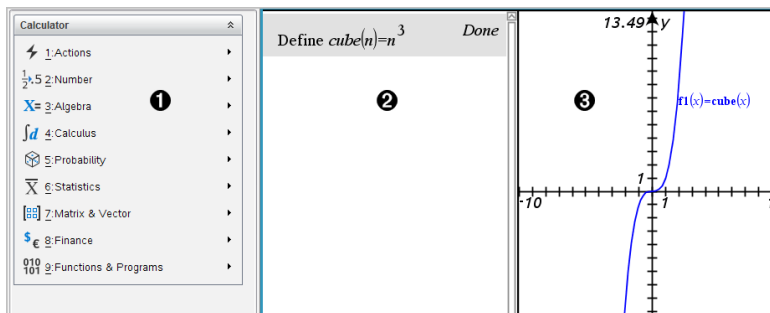

- 1 Calculator menu.** This menu is available anytime you are in the Calculator work area using the Normal view mode. The menu in this screen snapshot may not exactly match the menu on your screen.
- 2 Calculator work area**
  - Enter a maths expression on the entry line, and then press **Enter** to evaluate the expression.
  - Expressions are displayed in standard mathematical notation as you enter them.
  - Entered expressions and results show in the Calculator history.
- 3 Example of Calculator variables used in another application.**

## Entering and Evaluating Maths Expressions

### Entering Simple Maths Expressions

**Note:** To enter a negative number on the handheld, press  $\boxed{(-)}$ . To enter a negative number on a computer keyboard, press the hyphen key (-).

$$\frac{2^8 \cdot 43}{12}$$

Suppose you want to evaluate  $\frac{2^8 \cdot 43}{12}$

1. Select the entry line in the Calculator work area.
2. Type  $2^8$  to begin the expression.



A horizontal line representing a calculator display with the text  $2^8$  on the left side.

3. Press  $\blacktriangleright$  to return the cursor to the baseline.
4. Complete the expression:

Type  $*43/12$ .

Handheld: Type  $\boxed{\times}$  43  $\boxed{\div}$  12.



A horizontal line representing a calculator display with the text  $2^8 \cdot 43 / 12$  on the left side.

5. Press **Enter** to evaluate the expression.

The expression is displayed in standard mathematical notation, and the result is displayed on the right side of the Calculator.



A horizontal line representing a calculator display. On the left side, the text  $\frac{2^8 \cdot 43}{12}$  is shown. On the right side, the text  $\frac{2752}{3}$  is shown.

**Note:** If a result does not fit on the same line with the expression, it is displayed on the next line.

### Controlling the Form of a Result

You might expect to see a decimal result instead of  $2752/3$  in the preceding example. A close decimal equivalent is  $917.33333\dots$ , but that's only an approximation.



By default, Calculator retains the more precise form:  $2752/3$ . Any result that is not a whole number is shown in a fractional or exact (Exact Arithmetic and CAS) form, or symbolic form (CAS). This reduces rounding errors that could be introduced by intermediate results in chained calculations.

You can force a decimal approximation in a result:

- By pressing shortcut keys.



Windows®: Press **Ctrl+Enter** to evaluate the expression.

Mac®: Press **⌘+Enter** to evaluate the expression.

Handheld: Press   instead of  to evaluate the expression.



$\frac{2^{8.43}}{12}$	917.333
-----------------------	---------

Pressing   forces the approximate result.

- By including a decimal in the expression (for example, **43.** instead of **43**).



$2^{8.43.}$	917.333
-------------	---------

- By wrapping the expression in the **approx()** function.



$\text{approx}\left(\frac{2^{8.43}}{12}\right)$	917.333
---	---------

- By changing the document's **Auto or Approximate** mode setting to Approximate.

From the **File** menu, click **Settings > Document Settings**.

Handheld: Press  to display the **File** menu.

Note that this method forces all results in all of the document's problems to approximate.

## Inserting Items from the Catalogue

You can use the Catalogue to insert system functions and commands, symbols, and expression templates into the Calculator entry line.

1. Click the **Utilities** tab, and then click  to open the Catalogue.

Handheld: Press  **1**.

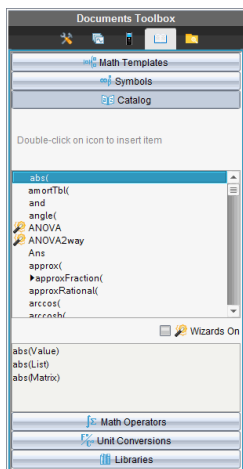

**Note:** Some functions have a wizard that prompts you for each argument. Those functions are shown with an indicator. To receive the prompts, select **Wizards On**.

2. If the item you are inserting is visible in the list, select it and press **Enter** to insert it.
3. If the item is not visible:
  - a) Click inside the list of functions, and then press a letter key to jump to the entries that begin with that letter.
  - b) Press **▲** or **▼** as necessary to highlight the item you are inserting.  
 Help, such as syntax information or a short description of the selected item, appears at the bottom of the Catalogue.
  - c) Press **Enter** to insert the item into the entry line.

### Using an Expression Template

The Calculator has templates for entering matrices, piecewise functions, systems of equations, integrals, derivatives, products, and other maths expressions.

$$\sum^n$$

For example, suppose you want to evaluate  $n=3$

1. On the **Utilities** tab, click  to open the templates.

Handheld: Press  $\left[ \frac{\square}{\square} \right]$ .

2. Double-click  $\sum_{\square}^{\square} \square$  to insert the algebraic sum template.

The template appears on the entry line with small blocks representing elements that you can enter. A cursor appears next to one of the elements to show that you can type a value for that element.

---

$$\sum_{\square}^{\square} (\square)$$

---

3. Use the arrow keys to move the cursor to each element's position, and type a value or expression for each element.

---

$$\sum_{n=3}^7 (n)$$

---

4. Press **Enter** to evaluate the expression.

---

$$\sum_{n=3}^7 (n) \quad 25$$

---

### Creating Matrices

1. On the **Utilities** tab, click  $\left[ \begin{smallmatrix} \square & \square \\ \square & \square \end{smallmatrix} \right]$  to open the templates.

Handheld: Press  $\left[ \frac{\square}{\square} \right]$ .

2. Double-click  $\begin{bmatrix} \square & \square \\ \square & \square \end{bmatrix}$ .

The Create a Matrix dialogue box opens.

**Create a Matrix**

Number of rows:   $\updownarrow$

Number of columns:   $\updownarrow$

3. Type the **Number of rows**.

4. Type the **Number of columns**, and then click **OK**.

Calculator opens a template with spaces for the rows and columns.

**Note:** If you create a matrix with a large number of rows and columns, it may take a few moments to appear.

5. Type the matrix values into the template, and then press **Enter** to define the matrix.

### Inserting a Row or Column into a Matrix

- ▶ To insert a new row, hold down **Alt** and press **Enter**.
- ▶ To insert a new column, hold down **Shift** and press **Enter**.

Handheld:

- ▶ To insert a new row, press .
- ▶ To insert a new column, press **Shift+Enter**.

### Inserting Expressions Using a Wizard

You can use a wizard to simplify entering some expressions. The wizard contains labelled boxes to help you enter the arguments in the expression.

For example, suppose you want to fit a  $y = mx + b$  linear regression model to the following two lists:

{1,2,3,4,5}

{5,8,11,14,17}

1. On the **Utilities** tab, click  to open the Catalogue.

Handheld: Press  1.

2. Click an entry in the Catalogue, and then press **L** to jump to the entries that begin with “L.”
3. Press **▼** as necessary to highlight **LinRegMx**.
4. Select the **Wizards On** option, if it is not already selected:

Handheld: Press **Tab Tab** to highlight **Wizards On**, press **Enter** to change the setting, and then press **Tab Tab** to highlight **LinRegMx** again.

5. Press **Enter**.

A wizard opens, giving you a labelled box to type each argument.

**Linear Regression (mx+b)**

X List:  ▶

Y List:  ▶

Save RegEqn to:  ▶

Frequency List:  ▶

Category List:  ▶

Include Categories:  ▶

6. Type {1, 2, 3, 4, 5} as **X List**.
7. Press **Tab** to move to the **Y List** box.
8. Type {5, 8, 11, 14, 17} as **Y List**.
9. If you want to store the regression equation in a specific variable, press **Tab**, and then replace **Save RegEqn To** with the name of the variable.
10. Click **OK** to close the wizard and insert the expression into the entry line.

Calculator inserts the expression and adds statements to copy the regression equation and show the variable *stat.results*, which will contain the results.

LinRegMx {1,2,3,4,5},{5,8,11,14,17},1: CopyVar stat.RegEqn,f2: stat.results

Calculator then shows the *stat.results* variables.

LinRegMx {1,2,3,4,5},{5,8,11,14,17},1: <i>stat.results</i>	
"Title"	"Linear Regression (mx+b)"
"RegEqn"	"m*x+b"
"m"	3.
"b"	2.
"r <sup>2</sup> "	1.
"r"	1.
"Resid"	" {... }"

**Note:** You can copy values from the *stat.results* variables and paste them into the entry line.

### Creating a Piecewise Function

1. Begin the function definition. For example, type the following expression:



**Define  $f(x, y) =$**

- On the **Utilities** tab, click  $\left\{ \begin{smallmatrix} \square \\ \square \\ \square \end{smallmatrix} \right\}$  to open the templates.

Handheld: Press  $\left[ \left\{ \begin{smallmatrix} \square \\ \square \\ \square \end{smallmatrix} \right\} \right]$ .

- Double-click  $\left\{ \begin{smallmatrix} \square \\ \square \\ \square \end{smallmatrix} \right\}$ .

The Create Piecewise Function dialogue box opens.

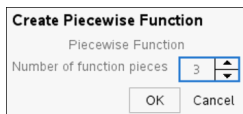

- Type the **Number of Function Pieces**, and click **OK**.

Calculator opens a template with spaces for the pieces.

- Type the expressions into the template, and press **Enter** to define the function.
- Enter an expression to evaluate or graph the function. For example, type the expression  $f(1, 2)$  on the Calculator entry line.

### Creating a System of Equations

- On the **Utilities** tab, click  $\left\{ \begin{smallmatrix} \square \\ \square \\ \square \end{smallmatrix} \right\}$  to open the templates.

Handheld: Press  $\left[ \left\{ \begin{smallmatrix} \square \\ \square \\ \square \end{smallmatrix} \right\} \right]$ .

- Double-click  $\left\{ \begin{smallmatrix} \square \\ \square \\ \square \end{smallmatrix} \right\}$ .

The Create a System of Equations dialogue box opens.

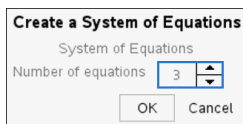

- Type the **Number of Equations**, and click **OK**.

Calculator opens a template with spaces for the equations.

- Type the equations into the template, and press **Enter** to define the system of equations.

## Entering Multiple Statements on the Entry Line

To enter several statements on a single line, separate them with a colon (":"). Only the result of the last expression is shown.

---

$$a:=5: b:=2: \frac{a}{b} \cdot 1. \qquad 2.5$$

---

## CAS: Working with Measurement Units

A list of pre-defined constants and measurement units is available in the Catalogue. You can also create your own units.

**Note:** If you know a unit's name, you can type the unit directly. For example, you can type `_qt` to specify quarts. To type the underscore symbol on the handheld, press

 .

### CAS: Converting Between Measurement Units

You can convert a value between any two units within the same category (such as length).

Example: Using the Catalogue, convert 12 metres to feet. The desired expression is `12*_m ► _ft`.

1. Type **12** on the entry line.
2. On the **Utilities** tab, click  to show the unit conversions.

Handheld: Press  **3**.

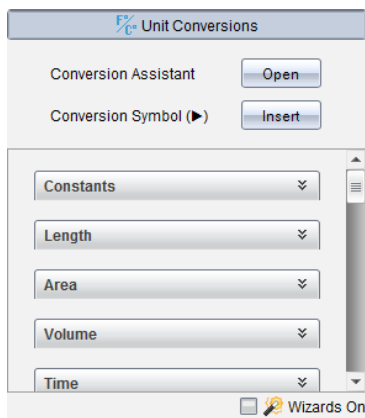

3. Click the **Length** category to expand the list of pre-defined length units.

Handheld: Scroll to the **Length** category, and press **Enter**.

4. Scroll to **metre**.

Handheld: Scroll to **\_m** (noting the **metre** hint in the Help window).

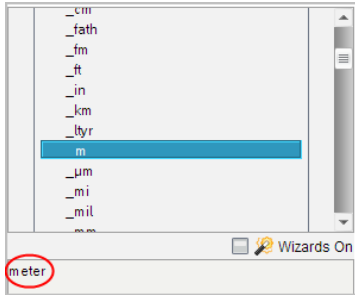

5. Press **Enter** to paste **\_m** to the entry line.

`12_m`

6. Click the Conversion Operator (**▶**) at the top of the Units list, and press **Enter** to paste it to the entry line.

`12_m▶`

7. Select **\_ft** from the Length category, and press **Enter**.

`12_m▶_ft`

8. Press **Enter** to evaluate the expression.

`12·_m▶_ft` `39.3701·_ft`

### CAS: Creating a User-defined Unit

As with the pre-defined units, user-defined unit names must begin with an underscore symbol.

Example: Using the pre-defined units `_ft` and `_min`, define a unit named `_fpm` that lets you enter velocity values in feet per minute and convert velocity results to feet per minute.

Define `_fpm =  $\frac{\_ft}{\_min}$`  `Done`

Now you can use the new velocity unit *\_fpm*.

15·_knot►_fpm	1519.03·_fpm
160·_mph►_fpm	14080·_fpm
500·_fpm►_knot	4.93737·_knot

## Using the Unit Conversion Assistant

In any application where maths input is allowed, you can generate unit conversions using the Unit Conversion Assistant. This can help reduce syntax errors by automatically entering the units for you.

Example: Convert 528 minutes to hours. The desired expression is  $528 \cdot \text{min} \blacktriangleright \text{hr}$ .

1. Type **528** on the entry line.
2. On the **Utilities** tab, click the **Unit Conversions** bar.

Handheld: Press  **3**.

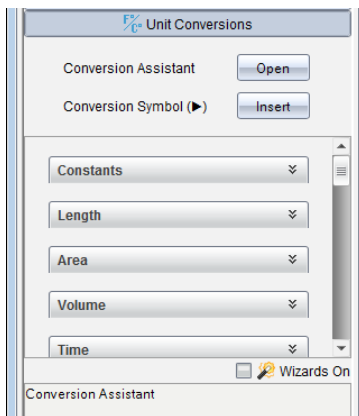

3. Click the **Open** button next to **Conversion Assistant**.

Handheld: Press .

The **Unit Conversion Assistant** dialogue box displays:

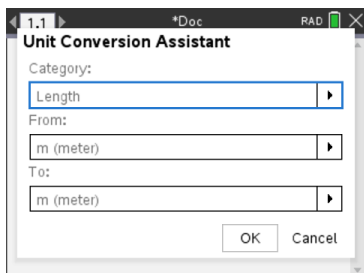

4. Click the **Category** list and select **Time**.

Handheld: Scroll to the **Time** category and press **enter**.

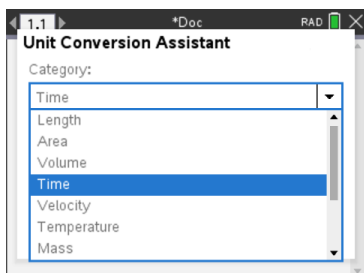

5. Click the **From** list and select **min (minute)**.

Handheld: Scroll to **min (minute)** and press **enter**.

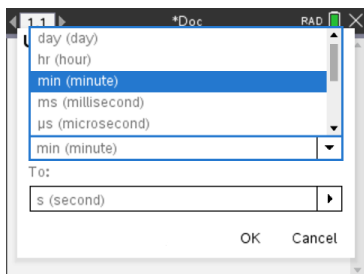

**Note:** You can select **Use existing unit** at the bottom of the list if you have already entered a unit. In this example, you might have already entered 528\*\_min.

6. Click the **To** list and select **hr (hour)**.

Handheld: Scroll to **hr (hour)** and press **enter**.

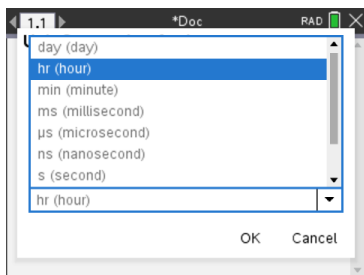

7. Click **OK** to paste `_min ► _hr` to the entry line.
8. Press **Enter** to evaluate the expression.

Handheld: Press `enter`.

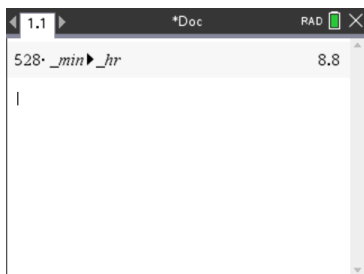

**Note:**

- The last Category, From, and To selections will be retained until:
  - the software is closed and re-opened (Desktop)
  - the device is reset (Handheld)
  - the language is changed, or the app is uninstalled or upgraded (iPad)
- Inserting a conversion into a Notes text field will automatically create a Maths Box.
- Inserting a conversion into an empty line in the Calculator will automatically insert **Ans** before the conversion.

### ***Working with Variables***

When you first store a value in a variable, you give the variable a name.

- If the variable does not already exist, Calculator creates it.
- If the variable already exists, Calculator updates it.

Variables within a problem are shared by TI-Nspire™ maths and science learning technology applications. For example, you can create a variable in Calculator and then use or modify it in Graphs & Geometry or Lists & Spreadsheet within the same problem.

For more information, see *Using Variables*.

## Creating User-defined Functions and Programmes

You can use the **Define** command to create your own functions and programmes. You can create them in the Calculator application or in the Programme Editor and then use them in other TI-Nspire™ applications.

For more information, see *Overview of the Programme Editor and Libraries*.

### Defining a Single-line Function

Suppose you want to define a function named **cube()** that calculates the cube of a number or variable.

1. On the Calculator entry line, type **Define cube(x)=x^3** and press **Enter**.

---

Define  $cube(x)=x^3$  Done

---

The message “Done” confirms that the function has been defined.

2. Type **cube(2)** and press **Enter** to test the function.

---

$cube(2)$  8

---

### Defining a Multiple-line Function Using Templates

You can define a function consisting of multiple statements entered on separate lines. A multiple-line function may be easier to read than one with multiple statements separated by colons.

**Note:** You can create multiple-line functions only by using the **Define** command. You cannot use the **:=** or **→** operators to create multiple-line definitions. The **Func...EndFunc** template serves as a container for the statements.

As an example, define a function named **g(x,y)** that compares two arguments  $x$  and  $y$ . If argument  $x >$  argument  $y$ , the function should return the value of  $x$ . Otherwise, it should return the value of  $y$ .

1. On the Calculator entry line, type **Define g(x,y)=**. Do not press **Enter** yet.

---

define  $g(x,y)=$

---

2. Insert the **Func...EndFunc** template.

From the **Functions & Programmes** menu, select **Func...EndFunc**.

Calculator inserts the template.

---

```
define g(x,y)=Func
      |
      EndFunc
```

---

3. Insert the **If...Then...Else...EndIf** template.

From the **Functions & Programmes** menu, select **Control**, and then select **If...Then...Else...EndIf**.

Calculator inserts the template.

---

```
define g(x,y)=Func
      If Then
      Else
      EndIf
      EndFunc
```

---

4. Type the remaining parts of the function, using the arrow keys to move the cursor from line to line.

---

```
define g(x,y)=Func
      If x>y Then
      return x
      Else
      return y
      EndIf
      EndFunc
```

---

5. Press **Enter** to complete the definition.
6. Evaluate **g(3, -7)** to test the function.

---

```
g(3,-7) 3
```

---

### Defining a Multiple-line Function Manually

Within a multi-line template such as **Func...EndFunc** or **If...EndIf**, you can start a new line without completing the definition.

- **Handheld:** Press **↵** instead of **enter**.
- **Windows®:** Hold **Alt** and press **Enter**.



- **Macintosh®:** Hold **Option** and press **Enter**.

As an example, define a function **sumIntegers(x)** that calculates the cumulative sum of integers from 1 to  $x$ .

1. On the Calculator entry line, type **Define sumIntegers(x)=**. Do not press **Enter** yet.

---

```
Define sumIntegers(x)=|
```

---

2. Insert the **Func...EndFunc** template.

From the **Functions & Programmes** menu, select **Func...EndFunc**.

Calculator inserts the template.

---

```
Define sumIntegers(x)=Func
                        |
                        ...
                        EndFunc
```

---

3. Type the following lines, pressing **↵** or **Alt+Enter** at the end of each line.

---

```
Define sumIntegers(x)=Func
    Local i,tmpsum
    tmpsum:=0
    For i,1,x
        tmpsum:=tmpsum+i|
    EndFor
    Return tmpsum
EndFunc
```

---

4. After typing **Return tmpsum**, press **Enter** to complete the definition.
5. Evaluate **sumIntegers(5)** to test the function.

---

```
sumintegers(5) 15
```

---

## Defining a Programme

Defining a programme is similar to defining a multiple-line function. The **Prgm...EndPrgm** template serves as a container for the programme statements.

As an example, create a programme named  $g(x,y)$  that compares two arguments. Based on the comparison, the programme should show the text " $x>y$ " or " $x\leq y$ " (showing the values of  $x$  and  $y$  in the text).

1. On the Calculator entry line, type **Define prog1(x,y)=**. Do not press **Enter** yet.

---

```
Define prog1(x,y)=|
```

---

2. Insert the **Prgm...EndPrgm** template.

From the **Functions & Programmes** menu, select **Prgm...EndPrgm**.

---

```
Define prog1(x,y)=Prgm
                    |
                    ...|
                    EndPrgm
```

---

3. Insert the **If...Then...Else...EndIf** template.

From the **Functions & Programmes** menu, select **Control**, and then select **If...Then...Else...EndIf**.

---

```
Define prog1(x,y)=Prgm
                    |
                    If|Then
                    |
                    Else
                    |
                    EndIf
                    EndPrgm
```

---

4. Type the remaining parts of the function, using the arrow keys to move the cursor from line to line. Use the Symbol Palette to select the " $\leq$ " symbol.

---

```
Define prog1(x,y)=Prgm
                    |
                    If x>y Then
                    |
                    Disp x, " > ",y
                    |
                    Else
                    |
                    Disp x, " ≤ ",y|
                    EndIf
                    EndPrgm
```

---

5. Press **Enter** to complete the definition.
6. Execute **prog1(3,-7)** to test the programme.

---

$prog1(3,-7)$

---

$3 > -7$

---

*Done*

---

## Recalling a Function or Programme Definition

You might want to reuse or modify a function or programme that you have defined.

1. Show the list of defined functions.

From the **Actions** menu, select **Recall Definition**.

2. Select the name from the list.

The definition (for example, **Define**  $f(x)=1/x+3$ ) is pasted into the entry line for editing.

## Editing Calculator Expressions

Although you cannot edit an expression in the Calculator history, you can copy all or part of an expression from the history and paste it to the entry line. You can then edit the entry line.

### Positioning the Cursor in an Expression

- Press tab, ◀, ▶, ▲ or ▼ to move the cursor through the expression. The cursor moves to the closest valid position in the direction that you press.

**Note:** An expression template may force the cursor to move through its parameters, even though some parameters may not be exactly in the path of the cursor movement. For example, moving upward from the main argument of an integral always moves the cursor to the top limit.

### Inserting into an Expression in the Entry Line

1. Position the cursor at the point where you want to insert additional elements.
2. Type the elements that you want to insert.

**Note:** When you insert an open parenthesis, Calculator adds a temporary close parenthesis, displayed in gray. You can override the temporary parenthesis by typing the same parenthesis manually or by entering something past the temporary parenthesis (thereby implicitly validating its position in the expression). After you override the temporary gray parenthesis, it is replaced with a black parenthesis.

### Selecting Part of an Expression

1. Position the cursor at the starting point in the expression.

Handheld: Press ◀, ▶, ▲ or ▼ to move the cursor.

2. Press and hold **⌘** (or **⇧**), and then press **◀**, **▶**, **▲** or **▼** to select.

### Deleting all or part of an expression on the entry line

1. Select the part of the expression to delete.
2. Press **del**.

## Financial Calculations

Several TI-Nspire™ functions provide financial calculations, such as time value of money, amortisation calculations, and return on investment calculations.

The Calculator application also includes a Finance Solver. It lets you dynamically solve several types of problems, such as loans and investments.

### Using the Finance Solver

1. Open the Finance Solver.

From the **Finance** menu, click **Finance Solver**.

The Finance Solver displays its default values (or previous values, if you have already used the solver in the current problem).

Finance Solver	
N:	0.
I(%):	0.
PV:	0.
Pmt:	0.
FV:	0.
PpY:	1

Press ENTER to calculate  
Number of Payments, N

2. Enter each known value, using **tab** to cycle through the items.
  - The help information at the bottom of the Finance Solver describes each item.
  - You might need to temporarily skip the value that you want to calculate.
  - Make sure to set **PpY**, **CpY** and **PmtAt** to the correct settings (12, 12 and END in this example).
3. Press **tab** as necessary to select the item that you want to calculate, and then press **enter**.

The Finance Solver calculates the value and stores all the values in “tvm.” variables, such as *tvm.n* and *tvm.pmt*. These variables are accessible to all TI-Nspire™ applications within the same problem.

Finance Solver	
N:	60
I(%):	10.5
PV:	25000
Pmt:	-537.34750945294
FV:	0.
PpY:	12

Finance Solver info stored into  
tvm.n, tvm.i, tvm.pv, tvm.pmt, ...

### Finance Functions Included

In addition to the Finance Solver, TI-Nspire™ built-in finance functions include:

- TVM functions for calculating future value, present value, number of payments, interest rate and payment amount.
- Amortisation information such as amortisation tables, balance, sum of interest payments and sum of principal payments.
- Net present value, internal rate of return and modified rate of return.
- Conversions between nominal and effective interest rates, and calculation of days between dates.

#### Notes:

- Finance functions do not automatically store their argument values or results to the TVM variables.
- For a complete list of TI-Nspire™ functions, see the *Reference Guide*.

### Working with the Calculator History

As you enter and evaluate expressions in the Calculator application, each entry/result pair is saved in the Calculator history. The history gives you a way to review your calculations, repeat a set of calculations, and copy expressions for reuse in other pages or documents.

#### Viewing the Calculator History

**Note:** You may notice a processing slowdown when the history contains a large number of entries.

- ▶ Press ▲ or ▼ to scroll through the history.

$\frac{3.76}{-7.9+\sqrt{5}}$	-0.66385
$-0.66384977522033+2\cdot\log_{10}(45)$	2.64258
$a:=5:b:=2:\frac{a}{b}\cdot 1$	2.5
Define $\text{cub}(x)=x^3$	Done

### Copying a Calculator History Item to the Entry Line

You can quickly copy an expression, subexpression, or result from the history into the entry line.

1. Press  $\blacktriangle$  or  $\blacktriangledown$  to move through the history and select the item that you want to copy.

—or—

Select part of the expression or result by using **Shift** in combination with the arrow keys.

$\frac{3.76}{-7.9+\sqrt{5}}$	-0.66385
------------------------------	----------

**Note:** The float setting for the current document may limit the number of decimal places displayed in a result. To capture the result in its full precision, select it either by scrolling with the up and down arrow keys or by triple-clicking it.

2. Press **Enter** to copy the selection and insert it into the entry line.

$\frac{3.76}{-7.9+\sqrt{5}}$
------------------------------

## Copying a History Item to Another Application

1. Press ▲ or ▼ to move through the history and select the item that you want to copy.
2. Optionally, select part of the expression or result by pressing **Shift** in combination with the arrow keys.
3. Use the standard key shortcut for copying a selection.

Windows®: Press **Ctrl+C**.

Mac®: Press **⌘+C**.

Handheld: Press **ctrl** **C**.

4. Place the cursor at the location where you want the copy.
5. Paste the copy.

Windows®: Press **Ctrl+V**.

Mac®: Press **⌘+V**.

Handheld: Press **ctrl** **V**.

**Note:** If you copy an expression that uses variables into a different problem, the values of those variables are not copied. You must define the variables in the problem where you paste the expression.

## Deleting an Expression from the History

When you delete an expression, all variables and functions defined in the expression retain their current values.

1. Drag or use the arrow keys to select the expression.

Handheld: Use the arrow keys.

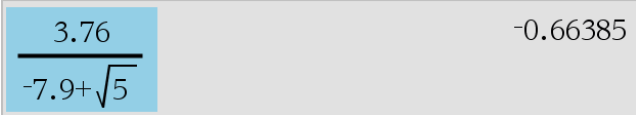

The image shows a calculator display with a light blue background. On the left, the expression  $\frac{3.76}{-7.9 + \sqrt{5}}$  is displayed and highlighted with a light blue selection box. On the right, the result  $-0.66385$  is displayed.

2. Press **Del**.

The expression and its result are removed.

## Clearing the Calculator History

When you clear the history, all variables and functions defined in the history retain their current values. If you clear the history by mistake, use the undo feature.

- ▶ From the **Actions** menu, select **Clear History**.

All expressions and results are removed from the history.



## Using Variables

A variable is a defined value that can be used multiple times in a problem. You can define a value or function as a variable within each application. Within a problem, variables are shared by TI-Nspire™ applications. For example, you can create a variable in Calculator, and then use or modify it in Graphs & Geometry or Lists & Spreadsheet within the same problem.

Each variable has a name and a definition and the definition can be changed. When you change the definition, all occurrences of the variable in the problem are updated to use the new definition. In the TI-Nspire™ software, a variable has four attributes:

- Name - User-defined name assigned when the variable is created.
- Location - Variables are stored in memory.
- Value - Number, text, mathematical expression or function.
- Type - Type of data that can be stored as a variable.

**Note:** Variables created with the **Local** command within a user-defined function or programme are not accessible outside that function or programme.

### *Linking Values on Pages*

Values and functions created or defined in one application can interact with other applications (within the same problem) to share data.

When using linked items, keep in mind:

- Values can be linked between applications on one page or between different pages of the same problem.
- All applications are linked to the same data.
- If the linked value is changed in the original application, the change is reflected in all linked usages.





Defining a variable is the first step in linking values.



### *Creating Variables*

Any portion or attribute of an object or function created within an application can be stored as a variable. Examples of attributes that can become variables are the area of a rectangle, the radius of a circle, the value contained in a spreadsheet cell or the contents of a row or column or a function expression. When you create a variable, it is stored in memory.

#### **Types of Variables**

You can store the following data types as variables:

Data type	Examples						
Expression 	2.54 1.25E6 2π xmin/10 2+3i (x-2) <sup>2</sup> √2						
List 	{2, 4, 6, 8} {1, 1, 2} {"red", "blue", "green"}						
Matrix 	<table border="1" data-bbox="326 305 414 392"> <tr><td>1</td><td>2</td><td>3</td></tr> <tr><td>3</td><td>6</td><td>9</td></tr> </table> This can be entered as: [1, 2, 3; 3, 6, 9]	1	2	3	3	6	9
1	2	3					
3	6	9					
Character string	"Hello" "xmin/10" "The answer is:"						
Function, programme 	myfunc( arg ) ellipse( x, y, r1, r2 )						
Measurement 	area, perimeter, length, slope, angle						

When you click  or press  on a handheld to open the list of stored variables, a symbol indicates the type.

### Creating a Variable from a Calculator Value



This example shows how to create a variable using a handheld. Complete the following steps to create a variable named *num* and store the result of the expression  $5+8^3$  in that variable.

1. On the Calculator entry line, type the expression  $5+8^3$ .



2. Press  to expand the cursor to the baseline.



3. Press   and then type the variable name *num*.



This means: Calculate  $5+8^3$  and store the result as a variable named *num*.

4. Press .

Calculator creates the variable *num* and stores the result there.

---

 $5+8^3 \rightarrow num$ 

---

517

### Creating a Variable in the Computer Software

When creating a variable in the computer software, use the following conventions. As alternatives to using  $\rightarrow$  (store), you can use “:=” or the **Define** command. All of the following statements are equivalent.

$5+8^3 \rightarrow num$

$num := 5+8^3$

Define  $num=5+8^3$ 

### Checking a Variable's Value

You can check the value of an existing variable by entering its name on the Calculator entry line. When you type the name of a stored variable, it appears in bold type.

- On the Calculator entry line, type the variable name **num** and press .

The value most recently stored in *num* is displayed as the result.

num	517
-----	-----

### Automatically Creating Variables in Graphs & Geometry

In the Graphs and Geometry applications, functions defined on the entry line are automatically stored as variables.



In this example,  $f1(x)=x^3$  is a variable definition, which allows it to be displayed in other applications including a table in the Lists & Spreadsheet application.

### Creating a Variable from a Graphs & Geometry Value

1. Click the value to store as a variable.

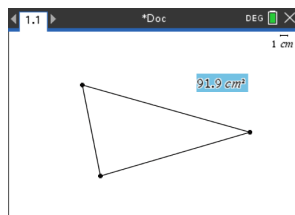

2. Click .

Handheld: Press .

The Variables options are displayed with **Store Var** highlighted.

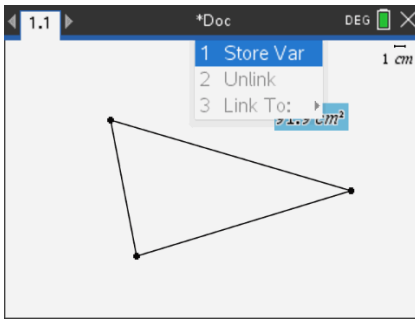

3. Press **enter**. VAR := appears before the selected value. This is the default name.

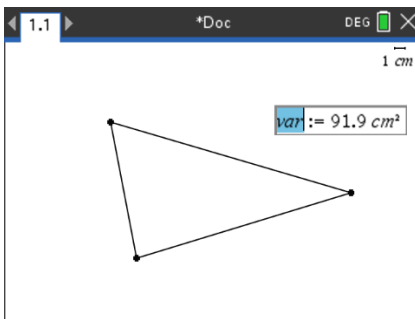

4. Replace the default name VAR with the variable name you want to give the value.

5. When the variable name is typed, press **enter**.

The value is saved to that variable name and the stored value or its name appears in bold text to indicate it is a stored value.

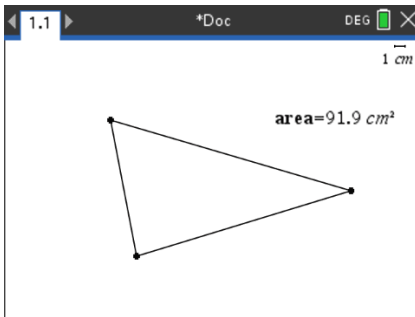

**Note:** You can also share a Graphs & Geometry axis end value with other applications. If necessary, click **Actions, Show/Hide Axes End Values** to display the end values on the horizontal and vertical axes. Click the number for an end value to highlight it in the entry field. Name the variable and store it for use with other applications by using any method described in Step 2.

### Automatically Creating Variables in Lists & Spreadsheet

Naming a list at the top of a Lists & Spreadsheet column automatically stores that value as a list variable. This variable can be used in other applications including Data & Statistics.

### Creating a Variable from a Lists & Spreadsheet Cell Value

You can share a cell value with other applications. When defining or referring to a shared cell in Lists & Spreadsheet, precede the name with an apostrophe (').

1. Click the cell that you want to share.
2. Click  to open the Variables menu.

Handheld: Press .

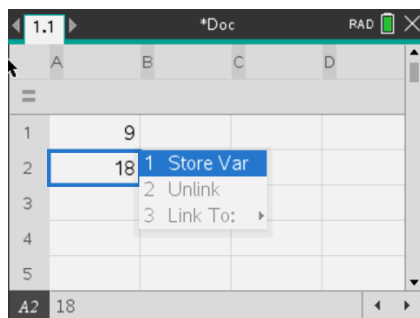

3. Click **Store Var**.

A formula is inserted into the cell with *var* as a placeholder for a variable name.

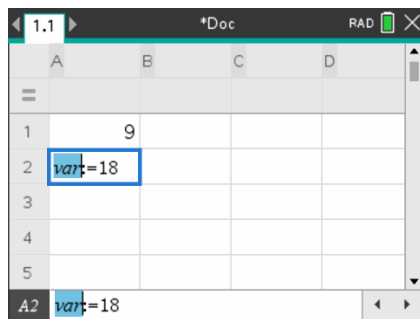

4. Replace the letters "*var*" with a name for the variable and press .

The value is now available as a variable to other applications within the same problem.

**Note:** If a variable with the name you specified already exists in the current problem space, Lists & Spreadsheet displays an error message.

## Using (Linking) Variables

Sharing, or linking, the variables you create is a powerful tool for maths exploration. The display of linked variables is automatically updated when the variable's value changes.

### Linking to Shared Variables

To use a stored variable:

1. Display the page and select the location or object to which you want to link a variable.
2. Select the Variables tool .

The Variables options are displayed. The software knows which types of variables will work in the location or with the object selected and will only display those variables.

3. Use ▲ and ▼ to scroll the list.

—or—

Type part of the variable name.

As you type, the system displays a list of variables that begin with the letters you typed. Typing part of the name enables you to locate a variable more quickly if the list is long.

4. When you locate and highlight the name of the variable you want to use, click the name.

—or—

Press .

The selected variable value is linked.



### Linking a Lists & Spreadsheet Cell to a Variable

When you link a cell to a variable, Lists & Spreadsheet keeps the cell value updated to reflect the current value of the variable. The variable can be any variable in the current problem and can be defined in Graphs & Geometry, Calculator or any instance of Lists & Spreadsheet.

**Note:** Do not link to a system variable. Doing so could prevent the variable from being updated by the system. System variables include *ans*, *StatMatrix* and statistics results (such as *RegEqn*, *dfError* and *Resid*).

1. Click the cell that you want to link to the variable.

2. Open the VarLink menu:

- Click , and then click **Cell**.
- Handheld: Press .

The VarLink menu is displayed.

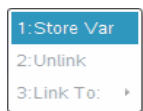



3. Under **Link To**, scroll to the name of the variable and click it.

The cell shows the value of the variable.

### Using a Variable in a Calculation

After storing a value in a variable, you can use the variable name in an expression as a substitute for the stored value.

1. Enter the expression:

- Type  $4*25*num^2$  on the entry line and press **Enter**.
- Handheld: Type  $4$    $25$    $num^2$  on the entry line and press .



Calculator substitutes 517, the value currently assigned to *num* and evaluates the expression.

---

$$4 \cdot 25 \cdot num^2 \qquad 26728900$$

---

2. Enter the expression:

- Type  $4*25*nonum^2$  and press **Enter**.
- Handheld: Type  $4$    $25$    $nonum^2$  on the entry line and press .

---

$$4 \cdot 25 \cdot nonum^2 \qquad 100 \cdot nonum^2$$

---

CAS: Because the variable *nonum* has not been defined, it is treated algebraically in the result.

---

$$4 \cdot 25 \cdot nonum^2$$

"Error: Variable is not defined"

---

Because the variable *nonum* has not been defined, the expression returns an error message.

## Naming Variables

Variable and function names that you create must meet the following naming rules.

**Note:** In the unlikely event that you create a variable with the same name as one used for statistical analysis or by the Finance Solver, an error condition could occur. If you begin entering a variable name that is already in use in the current problem, the software shows the entry in **bold** to let you know.

- Variable names must be in one of the forms  $xxx$  or  $xxx.yyy$ . The  $xxx$  part can have 1 to 16 characters. The  $yyy$  part, if used, can have 1 to 15 characters. If you use the  $xxx.yyy$  form, both  $xxx$  and  $yyy$  are required; you cannot start or end a variable name with a period ".".
- Characters can consist of letters, digits and the underscore character ( $_$ ). Letters can be U.S. or Greek letters (but not  $\Pi$  or  $\pi$ ), accented letters and international letters.
- Do not use **c** or **n** from the symbol palette to construct a variable name such as **c1** or **n12**. These may appear to be letters, but they are treated internally as special symbols.
- You can use uppercase or lowercase letters. The names  $AB22$ ,  $Ab22$ ,  $aB22$  and  $ab22$  all refer to the same variable.
- You cannot use a digit as the first character of  $xxx$  or  $yyy$ .
- You can use digits 0 through 9, U.S. letters, a - z, Latin and Greek letters (but not  $\pi$ ) as subscripts (for example,  $a_2$ ,  $q_a$ , or  $h_2o$ ). To enter a subscript while typing a variable name, select  $\square$  in the Math Templates or on the formatting toolbar.
- Do not use spaces.
- If you want a variable to be treated as a complex number, use an underscore as the last character of the name.
- CAS: If you want a variable to be treated as a type of unit (such as  $\_m$  or  $\_ft$ ), use an underscore as the first character of the name. You cannot use subsequent underscores in the name.
- You cannot use an underscore as the first character of the name.
- You cannot use a preassigned variable, function or command name, such as **Ans**, **min** or **tan**.

**Note:** For more information about TI-Nspire™ functions, see the *Reference Guide*.

- Library documents and library objects are subject to additional naming restrictions. For more information, see *Libraries*.

Here are some examples:

Variable names	Valid?
$Myvar$ , $my.var$	Yes



Variable names	Valid?
<i>My var, list l</i>	No. Contains a space.
<i>a, b, b12, b<sub>12</sub>, c, d</i>	Yes. Note that variables <i>b12</i> and <i>b<sub>12</sub></i> are distinct.
<i>Log, Ans</i>	No. Preassigned to a system function or variable.
<i>Log1, list1.a, list1.b</i>	Yes
<i>3rdTotal, list1.l</i>	No. <i>.xxx</i> or <i>yyy</i> starts with a digit.

## Adjusting Variable Values with a Slider

A slider control lets you interactively adjust or animate the value of a numeric variable. You can insert sliders in the Graphs, Geometry, Notes and Data & Statistics applications.

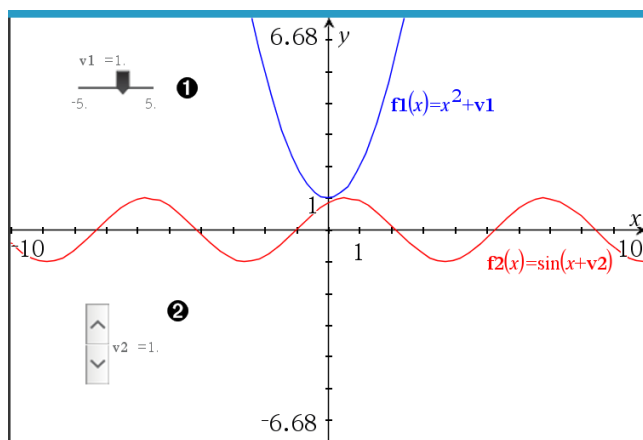

- ❶ Horizontal slider for adjusting variable  $v1$ .
- ❷ Minimised vertical slider for adjusting variable  $v2$ .

**Note:** TI-Nspire™ version 4.2 or higher is required for opening .tns files containing sliders on Notes pages.

### Inserting a Slider Manually

1. From a Graphs, Geometry or Data & Statistics page, select **Actions > Insert Slider**.  
—or—  
From a Notes page, make sure the cursor is not in a maths box or chem box, and then select **Insert > Insert Slider**.

The Slider Settings screen opens.

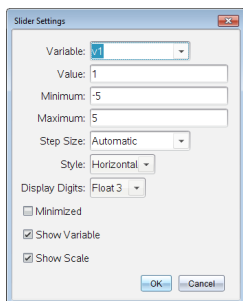

2. Enter the desired values, and click **OK**.

The slider is displayed. On a Graphs, Geometry or Data & Statistics page, handles are displayed to let you move or stretch the slider.

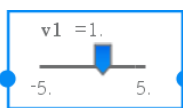

To remove the handles and use the slider, click an empty space in the work area. You can show the handles any time by selecting **Move** from the slider's context menu.

3. To adjust the variable, slide the pointer (or click the arrows on a minimised slider).
  - You can use the **Tab** key to move the focus to a slider or to move from one slider to the next. The colour of the slider changes to show you when it has the focus.
  - When a slider has the focus, you can use the arrow keys to change the value of the variable.

### Working with the Slider

Use the options on the context menu to move or delete the slider, and to start or stop its animation. You can also change the slider's settings.

1. Display the slider's context menu.

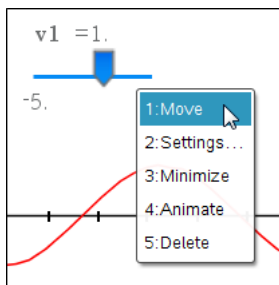

2. Click an option to select it.

## Automatic Sliders in Graphs

Sliders can be created for you automatically in the Graphs application and in the analytic window of the Geometry application. You are offered automatic sliders when you define certain functions, equations or sequences that refer to undefined variables.

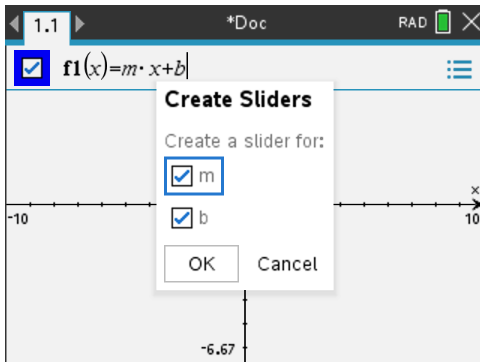

## Locking and Unlocking Variables

Locking lets you protect variables from modification or deletion. Locking prevents unintended changes to a variable.

	A time	B altitude
=		
1	seconds	meters
2	10	64
3	20	59
4	70	49
5	90	44
A.2	10	

Time and altitude lists can be locked to ensure problem fidelity

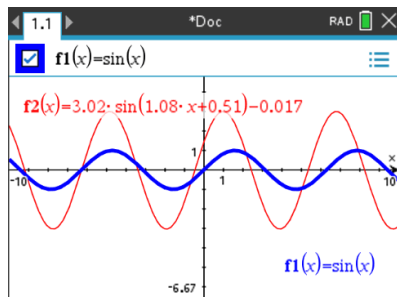

Reference function  $f_1$  can be locked to prevent unintended change

## Variables you Cannot Lock

- System variable  $Ans$
- $stat.$  and  $tvm.$  variable groups

## Important Information About Locked Variables

- To lock variables, use the Lock command.
- To modify or delete a locked variable, you must first unlock the item.
- Locked variables display a lock icon on the variable menu list.

- The Lock command clears the Redo/Undo history when applied to unlocked variables.

### Examples of Locking

<b>Lock a,b,c</b>	Locks variables $a$ , $b$ and $c$ from the Calculator application.
<b>Lock mystats.</b>	Locks all members of variable group <i>mystats</i> .
<b>UnLock func2</b>	Unlocks variable <i>func2</i> .
<b>lm:=getLockInfo (var2)</b>	Retrieves the current lock status of <i>var2</i> and assigns that value to <i>lm</i> in the Calculator application.

For more information, see the *Reference Guide*.

### Updating a Variable

If you want to update a variable with the result of a calculation, you must store the result explicitly.

Entry	Result	Comment
<b>a := 2</b>	2	
<b>a<sup>3</sup></b>	8	Result not stored in variable $a$ .
<b>a</b>	2	
<b>a := a<sup>3</sup></b>	8	Variable $a$ updated with result.
<b>a</b>	8	
<b>a<sup>2</sup> → a</b>	64	Variable $a$ updated with result.
<b>a</b>	64	

### Reusing the Last Answer

Each instance of Calculator automatically stores the last calculated result as a variable named *Ans*. You can use *Ans* to create a chain of calculations.

**Note:** Do not link to *Ans* or any system variable. Doing so could prevent the variable from being updated by the system. System variables include statistics results (such as *Stat.RegEqn*, *Stat.dfError* and *Stat.Resid*) and Finance Solver variables (such as *tvm.n*, *tvm.pmt* and *tvm.fv*).

As an example of using *Ans*, calculate the area of a garden plot that is 1.7 meters by 4.2 meters. Then use the area to calculate the yield per square meter if the plot produces a total of 147 tomatoes.

1. Calculate the area:

- On the Calculator entry line, type  $1.7 * 4.2$  and press **Enter**.
- Handheld: On the Calculator entry line, type  $1.7$    $4.2$  and press .

---

1.7·4.2	7.14
---------	------

---

2. Reuse the last answer to calculate the yield per square meter:

- Type **147/ans** and press **Enter** to find the yield.
- Handheld: Type **147**  $\boxed{\div}$  **ans** and press  $\boxed{\text{enter}}$  to find the yield.

---

147	20.5882
7.14	

---

3. As a second example, calculate  $\frac{3.76}{-7.9+\sqrt{5}}$  and then add  $2 \cdot \log(45)$ .

- Type **3.76/(-7.9+sqrt(5))** and press **Enter**.
- Handheld: Type **3.76**  $\boxed{\div}$   $\boxed{(-)}$ **7.9+sqrt(5))** and press  $\boxed{\text{enter}}$ .

---

3.76	-0.66385
$-7.9+\sqrt{5}$	

---

4. Reuse the last answer:

- Type **ans+2\*log(45)** and press **Enter**.
- Handheld: Type **ans+2**  $\boxed{\times}$  **log(45)** and press  $\boxed{\text{enter}}$ .

---

$-0.66384977522033+2 \cdot \log_{10}(45)$	2.64258
---	---------

---

### Temporarily Substituting a Value for a Variable

Use the “|” (such that) operator to assign a value to a variable for just a single execution of the expression.

---

$a:=200.12$	200.12
-------------	--------

---

$a^2 a=100$	10000
-------------	-------

---

$a$	200.12
-----	--------

---

### Removing a Linked Variable

1. Select the linked variable.
2. Press  $\boxed{\text{var}}$ .

The Variables options are displayed.

3. Select **Unlink**.

The link is removed from the value and the value is displayed without any bold formatting.

# Graphs Application



The Graphs application lets you:

- Graph and explore functions and other relations, such as inequalities, parametrics, polars, sequences, differential equation solutions, and conics.
- Animate points on objects or graphs and explore their behaviour.
- Link to data created by other applications.

## Adding a Graphs Page

- ▶ To start a new document with a blank Graphs page:

From the main **File** menu, click **New Document**, and then click **Add Graphs**.

Handheld: Press , and select **Graphs** .

- ▶ To add a Graphs page in the current problem of an existing document:

From the toolbar, click **Insert > Graphs**.

Handheld: Press  and select **Insert > Graphs**.

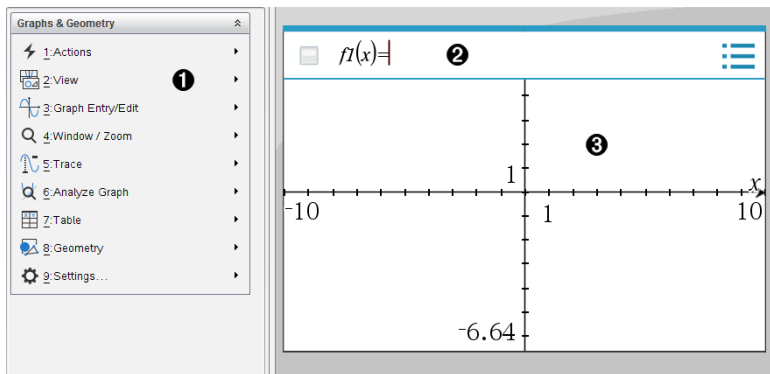

- 1 Graphs & Geometry menu.** Contains tools for defining, viewing, and investigating relations.
- 2 Entry line.** Lets you define the relations that you want to graph. The default graph type is Function, so the form  $f(x)=$  is displayed initially. You can define multiple relations for each of several graph types.
- 3 Graphs Work Area**
  - Shows graphs of relations that you define on the entry line.
  - Shows points, lines, and shapes that you create with geometry tools.
  - Drag the area to pan (affects only those objects created in the Graphs application).

## What You Must Know

### Changing the Graphs and Geometry Settings

1. From the **Settings** menu in the Documents Toolbox, select **Settings**.
2. Select the settings that you want to use.
  - **Display Digits.** Sets the display format for numbers as Floating or Fixed decimal.
  - **Graphing Angle.** Sets the angle unit for all Graphs and 3D Graphing applications in the current document. The default setting is Radian. Set this to Auto if you want graphing angles to follow the Angle setting in the main **File > Settings** menu. An angle mode indicator shows the resulting mode in Graphs and 3D Graphing applications.
  - **Geometry Angle.** Sets the angle unit for all Geometry applications in the current document. The default setting is Degree. Set this to Auto if you want geometry angles to follow the Angle setting in the main **File > Settings** menu. An angle mode indicator shows the resulting mode in Geometry applications.
  - **Grid.** Sets the grid display in the Graphs application. The default setting is No Grid. Dot Grid and Lined Grid are also available.
  - **Automatically hide plot labels.** In the Graphs application, hides the label that normally appears next to a graphed relation.
  - **Show axis end values.** Applies only in the Graphs application.
  - **Show tool tips for function manipulation.** Applies only in the Graphs application.
  - **Automatically find points of interest.** In the Graphs application, shows zeros, minima and maxima while tracing function graphs.
  - **Force Geometric Triangle Angles to Integers.** Restricts the angles of a triangle to integer values as you create or edit the triangle. This setting applies only in the Geometry View with the Geometry Angle unit set to Degree or Radian. It does not apply to analytic triangles in Graphing View or to analytic triangles in the Analytic Window of the Geometry View. This setting does not affect existing angles, and it does not apply when constructing a triangle based on previously inserted points. By default, this setting is deselected.
  - **Automatically Label Points.** Applies labels ( $A, B, \dots, Z, A_1, B_1,$  and so on) to points, lines, and vertices of geometric shapes as you draw them. The labelling sequence starts at  $A$  for each page in a document. By default, this setting is deselected.



**Note:** If you create a new object that uses existing un-labelled points, those point are not automatically labelled in the completed object.



- Click **Restore** to restore all settings to their factory defaults.
- Click **Make Default** to apply the current settings to the open document and save them as the default for new Graphs and Geometry documents.

## Using Context Menus

Context menus provide quick access to commonly used commands and tools that apply to a specific object. For example, you can use a context menu to change an object's line colour or to group a set of selected objects.

- Display the context menu for an object in one of the following ways.
- Windows®: Right-click the object.
  - Mac®: Hold  and click the object.
  - Handheld: Move the pointer to the object, and then press  .

## Finding Hidden Objects in the Graphs or Geometry Application

You can hide and show individual graphs, geometric objects, text, labels, measurements and axis end-values.

To temporarily view hidden graphs or objects or to restore them as shown objects:

1. From the **Actions** menu, select **Hide/Show**.

The Hide/Show tool  appears in the work area, and all hidden objects become visible in dimmed colours.

2. Click a graph or object to toggle its Hide/Show state.
3. To apply the changes and close the Hide/Show tool, press **ESC**.

## Inserting a Background Image

You can insert an image as a background for a Graphs or Geometry page. The file format of the image can be .bmp, .jpg or .png.

1. From the **Insert** menu, click **Image**.
2. Navigate to the image you want to insert, select it and then click **Open**.

For information on moving, resizing, and deleting a background image, see [Working with Images in the Software](#).

## Adding Text to the Graphs or Geometry Work Area

1. From the **Actions** menu, select **Text**.

The Text tool  appears in the work area.

2. Click the location for the text.
3. Type the text in the box that appears, and then press **Enter**.

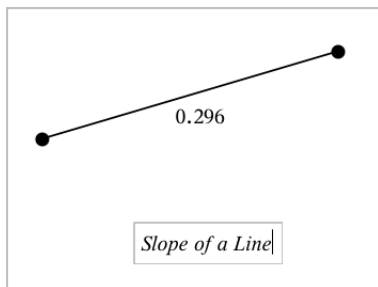

4. To close the Text tool, press **ESC**.
5. To edit the text, double-click it.

### Deleting a Relation and its Graph

1. Select the relation by clicking its graph.
2. Press **Backspace** or **DEL**.

The graph is removed from both the work area and the graph history.

### Graphing Functions

1. From the **Graph Entry/Edit** menu, select **Function**.

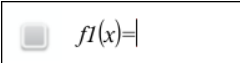

A graphing function input box showing the expression  $f1(x)=|$ .

2. Type an expression for the function.

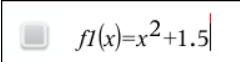

A graphing function input box showing the expression  $f1(x)=x^2+1.5|$ .

3. Press **Enter** to graph the function.

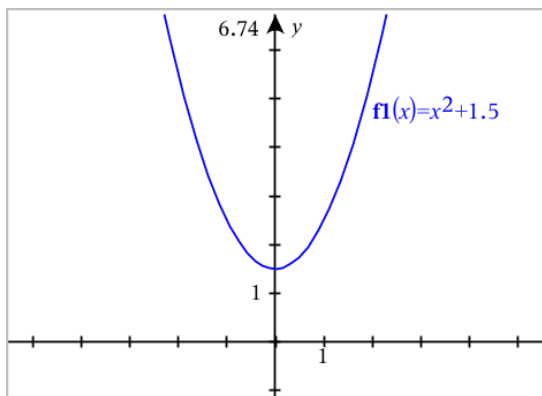

**Note:** For information about path plots, see [Exploring Graphs with Path Plot](#).

## Exploring Graphs with Path Plot

Path Plot lets you animate function, parametric, and polar equation plots in real time to analyse how they are plotted and not just the final plot.

### Changing the Path Plot Settings

1. From the **Trace** menu, select **Path Plot > Path Set-up**.

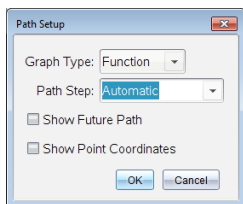

2. Select the settings you want to use.
  - **Graph Type:** Selects Function, Parametric, or Polar as the graph type.
  - **Path Step:** Sets the increment of the independent variable at which values are plotted.
  - **Show Future Path:** Toggles the display of all future points for each function past the starting or current point of the graph. You can also toggle this when viewing the graph with the Up/Down arrow keys.
  - **Show Point Coordinates:** Toggles the display of the coordinates for recorded trace points.

### Enabling Path Plot

1. Enter your equation(s).
2. From the **Trace** menu, select **Path Plot > Function/Parametric/Polar**.
3. Navigate through the animation by:

- using the Play/Pause/Reset Animation icons
- using the Left/Right arrow keys
- entering a number to jump to that point

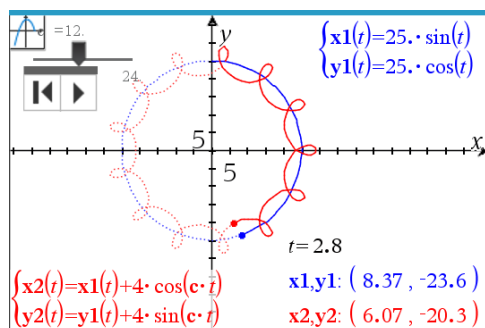

4. Press the **Esc** key to exit the animation.

### Manipulating Functions by Dragging

Some types of functions can be translated, stretched, and/or rotated by dragging parts of the graph. As you drag, the expression for the graph updates to reflect the change.

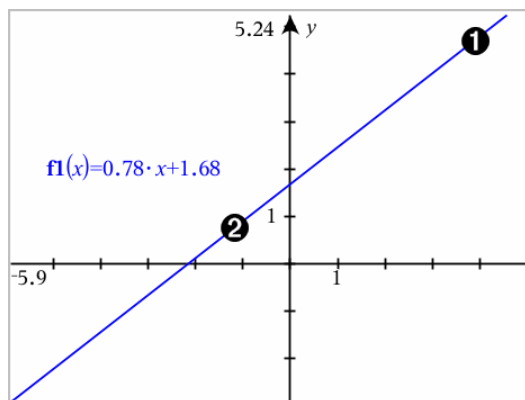

- 1 Drag graph from the ends to rotate.
- 2 Drag graph near the middle to translate.

### Manipulating a Linear Function

- To translate, grab near the middle of the graph, and then drag.

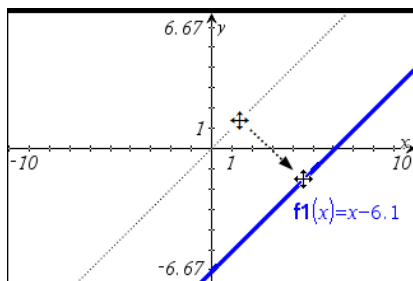

- To rotate, grab near the ends of the graph, and then drag.

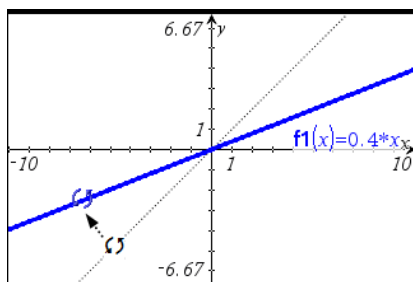

### Manipulating a Quadratic Function

- To translate, grab near the vertex of the graph, and then drag.

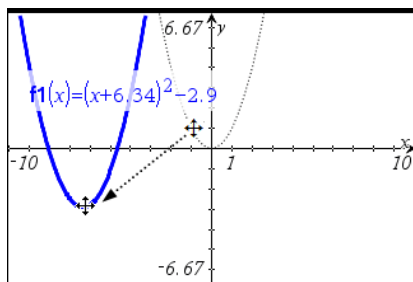

- To stretch, grab away from the vertex of the graph, and then drag.

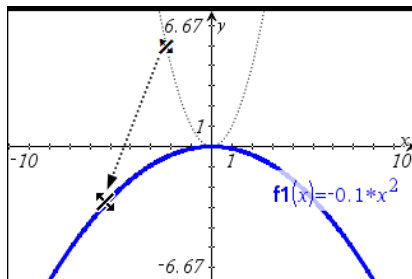

### Manipulating a Sine or Cosine Function

- ▶ To translate, grab near the axis of vertical symmetry of the graph, and then drag.

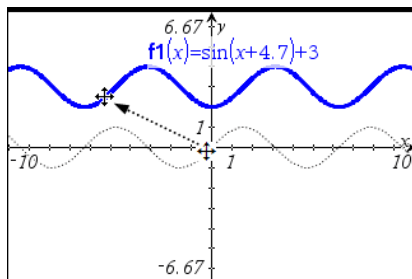

- ▶ To stretch, grab away from the axis of vertical symmetry of the graph, and then drag.

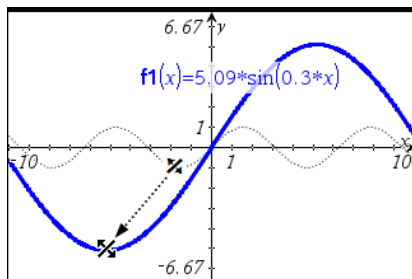

### Specifying a Function with Domain Restrictions

You can use the entry line or the Calculator application to specify a function with domain restrictions. For multiple domain restrictions on a function, use the **piecewise()** function.

In the following example, a function with a domain that is less than 2 and greater than -2 is specified on the entry line:

1. From the **Graph Entry/Edit** menu, select **Function**.

2. Type the following on the entry line, using spaces to separate the "and" operator:

`piecewise(3,x>-2 and x<2)`

3. Tap **Enter** to graph the function.

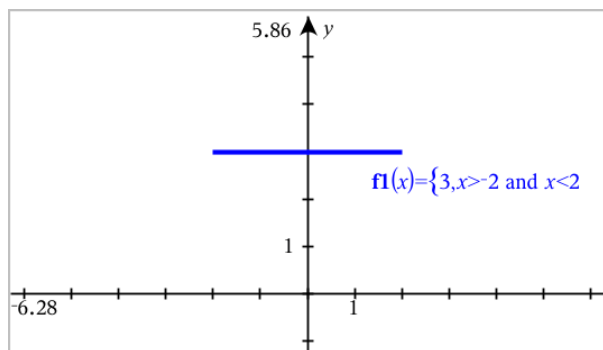

### ***Finding Points of Interest on a Function Graph***

The Graphs application helps you find zeros, minimums, maximums, intersections, derivatives ( $dy/dx$ ), or integrals. For Graphs defined as conic sections, you can also find foci, directrix, and other points.

**(CAS):** You can also find the point of inflection.

#### **Identifying Points of Interest by Dragging a Point**

- ▶ To quickly identify maximums, minimums, and zeros, [create a point on the graph](#) and then drag the point.

Temporary signposts appear as you drag through points of interest.

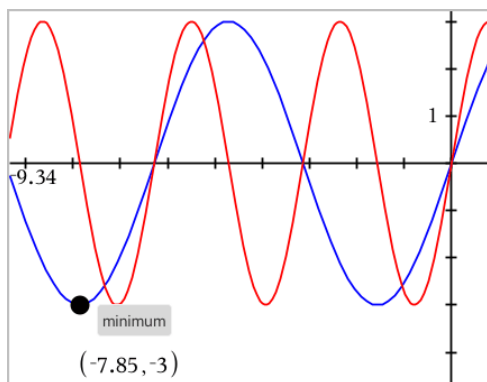

#### **Identifying Points of Interest with Analysis Tools**

This example illustrates using the Minimum tool. Other analysis tools operate similarly.

1. From the **Analyse Graph** menu, select **Minimum**.

The Minimum icon is displayed at the top left on the work area, and a **graph?** prompt appears in the work area.

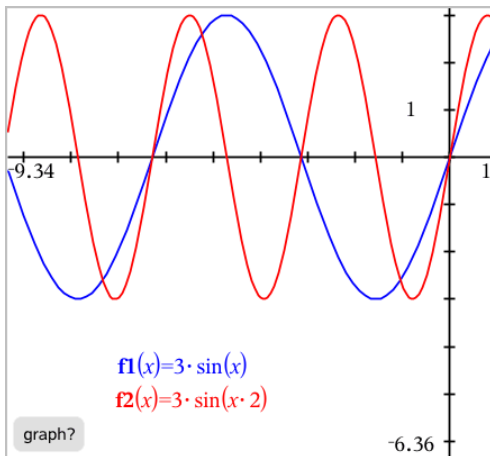

2. Click the graph on which you want to find the minimum.

A dotted line appears, representing the lower bound of the range to search.

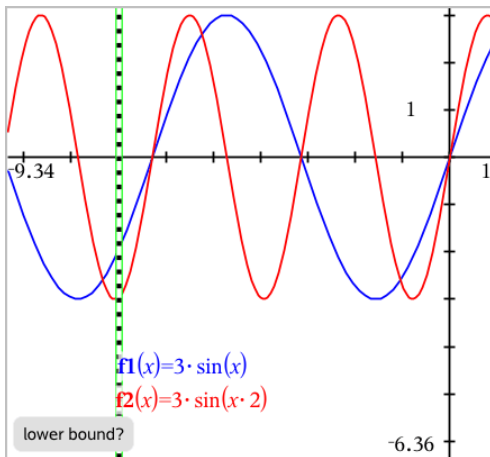

3. Drag the line or click a location to set the lower bound and display a proposed upper bound.



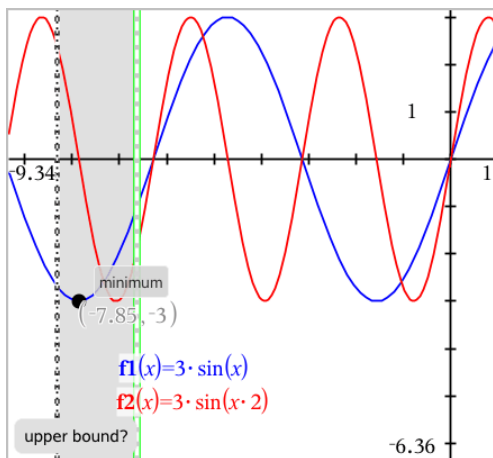

4. Drag the line representing the upper bound, or click a location to set it.

The minimum is displayed, along with a text object showing its coordinates.

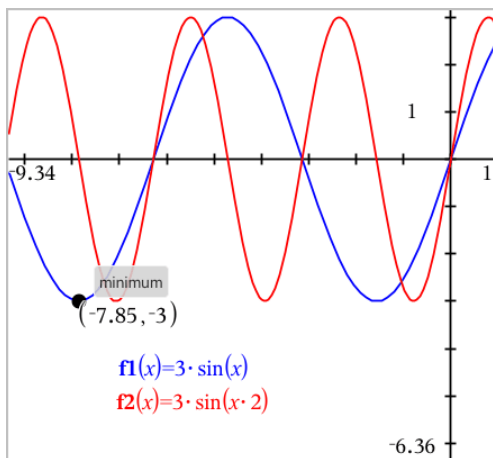

### Graphing a Family of Functions

In a family of functions, each member has its own value for one or more of the parameters. By entering the parameters as lists, you can use a single expression to graph a family of up to 16 functions.

For example, the expression  $f1(x) = \{-1,0,1,2\} \cdot x + \{2,4,6,8\}$  denotes the following four functions:

$$f1\_1(x) = -1 \cdot x + 2$$

$$f1\_2(x) = 0 \cdot x + 4$$

$$f1_3(x) = 1 \cdot x + 6$$

$$f1_4(x) = 2 \cdot x + 8$$

### To Graph a Family of Functions

1. From the **Graph Entry/Edit** menu, select **Function**.
2. Type the expression, using lists to represent the members of the family.

$$f1(x) = \{-1, 0, 1, 2\} \cdot x + \{2, 4, 6, 8\}$$

3. Press **Enter** to graph the functions.

Each member is labelled separately ( $f1_1$ ,  $f1_2$ , and so on) to indicate its sequence in the expression.

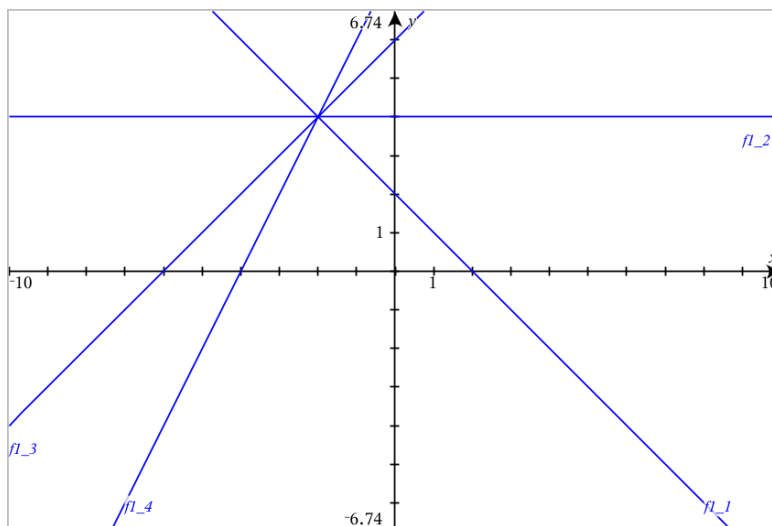

**Note:** You cannot edit a single function graph to change it to a family of functions.

### Graphing Equations

1. From the **Graph Entry/Edit** menu, select **Equation**.
2. Click the type of equation (**Line**, **Parabola**, **Circle**, **Ellipse**, **Hyperbola**, or **Conic**).
3. Click the specific template for the equation. For example, tap  $y = a \cdot x^2 + b \cdot x + c$  to define a parabola.

The entry line includes a symbol to indicate the type of equation.

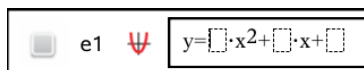

4. Type the coefficients into the equation template.

e1  $y=1 \cdot x^2+2 \cdot x+3$

5. Press **Enter**.

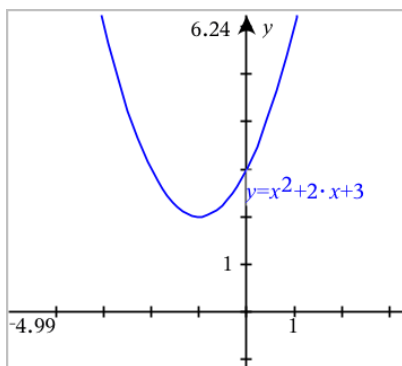

### Graphing Conic Sections

The Graphing view lets you graph and explore linear and conic equations analytically in a two-dimensional coordinate system. You can create and analyse lines, circles, ellipses, parabolas, hyperbolas, and general conic equations.

The entry line makes it easy to enter the equation by displaying a template for the type of equation you choose.

#### Example: Creating a conic ellipse

1. From the **Graph Entry/Edit** menu, select **Equation > Ellipse**, and tap the  $\oplus$  equation type.

e1  $\oplus$   $\frac{(x-\square)^2}{\square^2} + \frac{(y-\square)^2}{\square^2} = 1$

2. Type initial values for the coefficients in the provided spaces. Use the arrow keys to move among the coefficients.

e1  $\oplus$   $\frac{(x-1)^2}{5^2} + \frac{(y-2)^2}{4^2} = 1$

3. Press **Enter** to graph the equation.

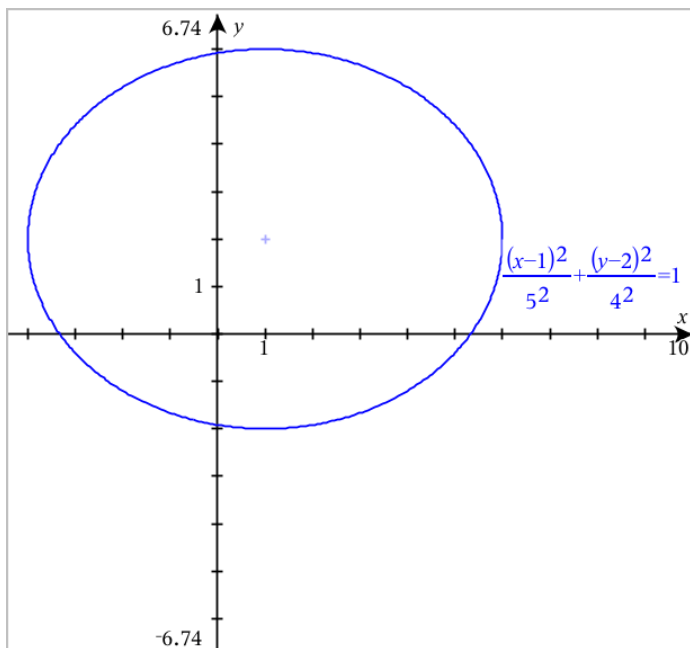

### Exploring the sample ellipse

1. Drag the ellipse from its centre to explore the effect of translation on the equation.

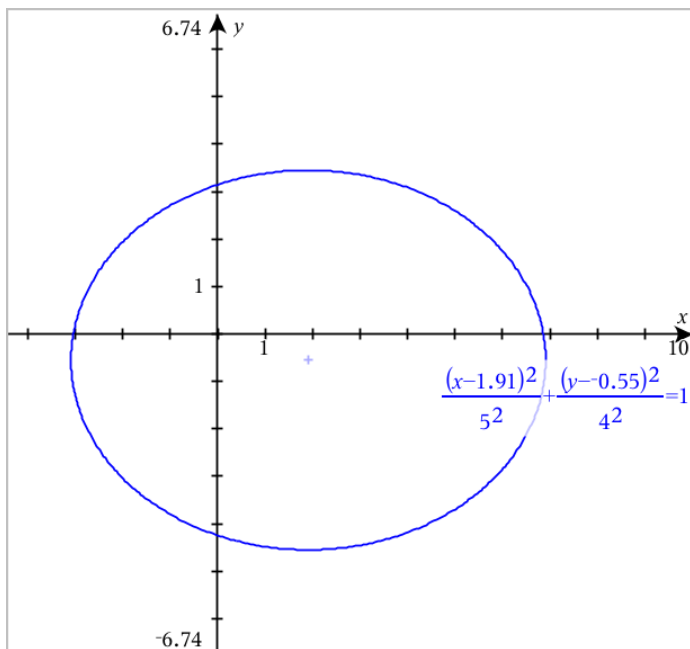

2. Use the analysis tools, such as **Analyse Graph > Analyse Conics > Foci** to further explore the graph.

**Note:** The type of conic determines which analysis tools you can use. In the case of the ellipse, you can obtain its centre, vertices, foci, axes of symmetry, directrices, eccentricity, and latera recta.

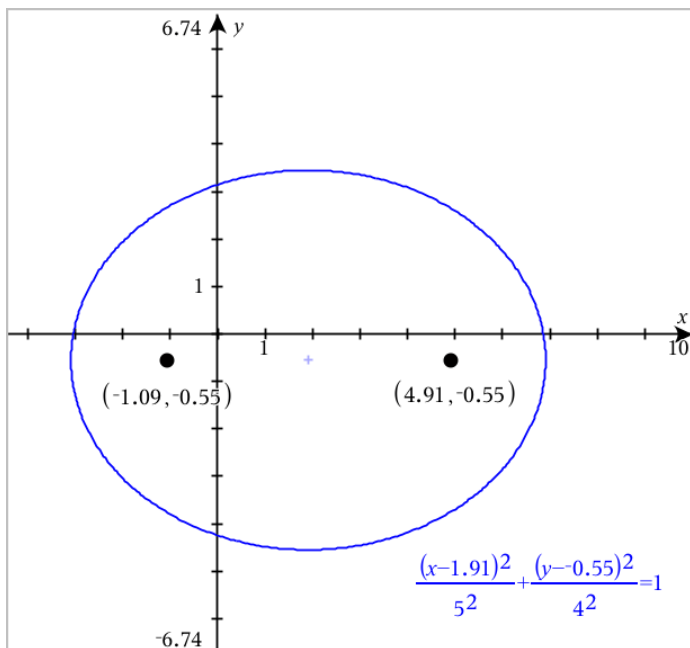

3. To explore translation and dilation interactively, define a conic ellipse that uses variables for the  $h$ ,  $k$ ,  $a$ , and  $b$  coefficients. Insert sliders to vary the parameters.

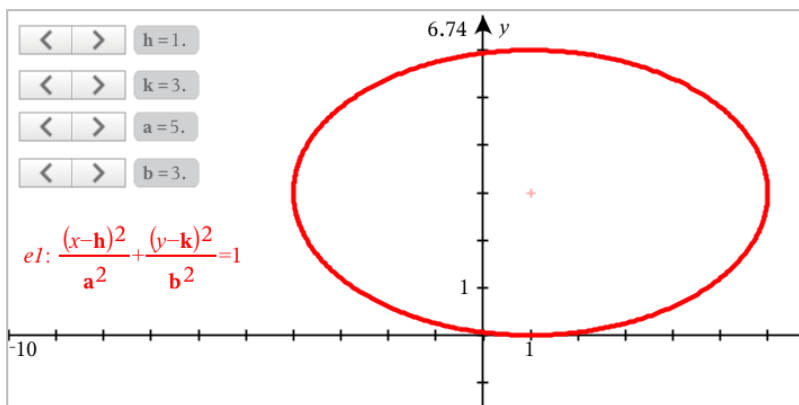

## Graphing Relations

Relation graphing is available on Graphs pages and in the Analytic Window of Geometry pages.

You can define relations using  $\leq$ ,  $<$ ,  $=$ ,  $>$  or  $\geq$ . The inequality operator ( $\neq$ ) is not supported in relation graphing.

Relation type	Examples
Equations and inequalities equivalent to $y = f(x)$	<ul style="list-style-type: none"> <li><math>y = \sqrt{x}</math></li> <li><math>y - \sqrt{x} = 1/2</math></li> <li><math>-2 * y - \sqrt{x} = 1/2</math></li> <li><math>y - \sqrt{x} \geq 1/2</math></li> <li><math>-2 * y - \sqrt{x} \geq 1/2</math></li> </ul>
Equations and inequalities equivalent to $x = g(y)$	<ul style="list-style-type: none"> <li><math>x = \sin(y)</math></li> <li><math>x - \sin(y) = 1/2</math></li> <li><math>x - \sin(y) \geq 1/2</math></li> </ul>
Polynomial equations and inequalities	<ul style="list-style-type: none"> <li><math>x^2 + y^2 = 5</math></li> <li><math>x^2 - y^2 \geq 1/2 + y</math></li> <li><math>x^3 + y^3 - 6 * x * y = 0</math></li> </ul>
The above relations on domains restricted by rectangles	<ul style="list-style-type: none"> <li><math>y = \sin(x)</math> and <math>-2\pi &lt; x \leq 2\pi</math></li> <li><math>y \leq x^2 \mid y \geq -2</math> and <math>0 \leq x \leq 3</math></li> <li><math>\{x^2 + y^2 \leq 3, y \geq 0</math> and <math>x \leq 0</math></li> </ul>

**Note:** Restrictions imposed by an active Press-to-Test session may limit the types of relations you can graph.

### To Graph a Relation:

1. From the **Graph Entry/Edit** menu, select **Relation**.



2. Type an expression for the relation.



3. Press **Enter** to graph the relation.

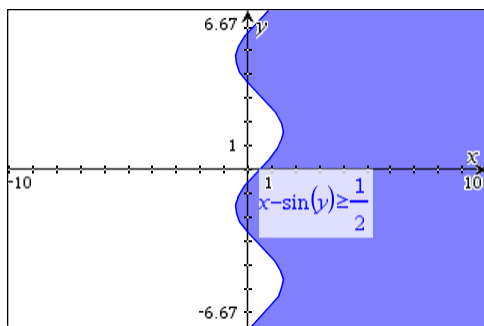

### Tips for Graphing Relations

- ▶ You can quickly define a relation from the Function entry line. Position the cursor to the immediate right of the = sign, and then press the **Backspace** key. A small menu appears with the relation operators and a **Relation** option. Choosing from the menu places the cursor in the Relation entry line.
- ▶ You can type a relation as text on a Graphs page and then drag the text object over either axis. The relation is graphed and added to the relation history.

### Warning and Error Message

Error Condition	Additional Information
Relation input not supported	<p><b>Relation input not supported</b></p> <p><b>Note:</b> The following relation inputs are supported:</p> <ul style="list-style-type: none"> <li>• Relations using <math>\leq</math>, <math>&lt;</math>, <math>=</math>, <math>&gt;</math>, or <math>\geq</math>.</li> <li>• Polynomial relations in <math>x</math> and <math>y</math></li> <li>• Relations equivalent to <math>y=f(x)</math> or <math>x=g(y)</math> or corresponding inequalities</li> <li>• The above relations on domains restricted by rectangles</li> </ul>
Domain Restrictions not supported for certain classes of relations equivalent to $y=f(x)$ or $x=g(y)$ or corresponding inequalities.	<ul style="list-style-type: none"> <li>• Relations equivalent to <math>y=f(x)</math> and corresponding inequalities can only have constraints on <math>x</math></li> <li>• For example: <math>y=v(x)</math> and <math>0 \leq x \leq 1</math> will work but <math>y=v(x)</math> and <math>0 \leq y \leq 1</math> will not</li> <li>• Relations equivalent to <math>x=g(y)</math> and corresponding inequalities can only have constraints on <math>y</math></li> <li>• For example: <math>x=\sin(y)</math> and <math>-1 \leq y \leq 1</math> will work but <math>x=\sin(y)</math> and <math>-1 \leq x \leq 1</math> will not</li> </ul>



## Graphing Parametric Equations

1. From the **Graph Entry/Edit** menu, select **Parametric**.

Use the up and down arrow keys to move among the fields in the Parametric entry line.

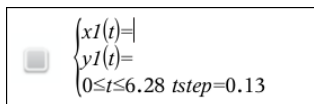

A screenshot of a calculator's parametric equation entry screen. It shows a small cursor icon on the left, followed by the equations  $x1(t)=|$ ,  $y1(t)=$ , and  $0 \leq t \leq 6.28$   $tstep=0.13$ .

2. Type expressions for  $xn(t)$  and  $yn(t)$ .

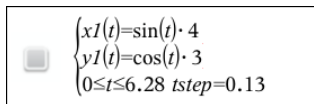

A screenshot of a calculator's parametric equation entry screen. It shows a small cursor icon on the left, followed by the equations  $x1(t)=\sin(t) \cdot 4$ ,  $y1(t)=\cos(t) \cdot 3$ , and  $0 \leq t \leq 6.28$   $tstep=0.13$ .

3. (Optional) Edit the default values for  $tmin$ ,  $tmax$ , and  $tstep$ .
4. Press **Enter**.

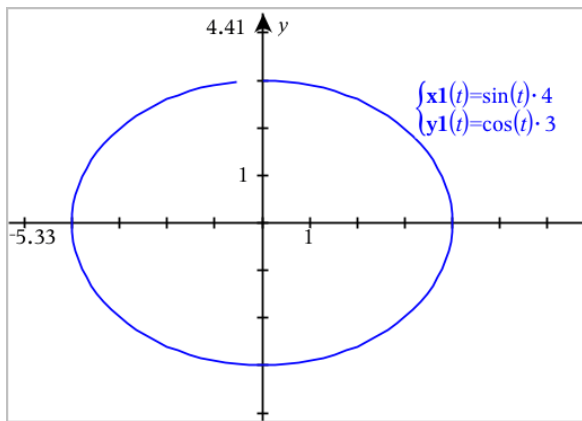

**Note:** For information about path plots, see [Exploring Graphs with Path Plot](#).

## Graphing Polar Equations

1. From the **Graph Entry/Edit** menu, select **Polar**.

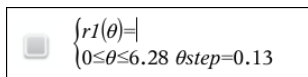

A screenshot of a calculator's polar equation entry screen. It shows a small cursor icon on the left, followed by the equation  $r1(\theta)=|$  and  $0 \leq \theta \leq 6.28$   $\thetastep=0.13$ .

2. Type an expression for  $rn(\theta)$ .
3. (Optional) Edit the default values for  $\theta min$ ,  $\theta max$ , and  $\theta step$ .

$$\begin{cases} r1(\theta) = .2 \cdot \theta \\ 0 \leq \theta \leq (\pi \cdot 10) \quad \theta \text{step} = 0.13 \end{cases}$$

4. Press **Enter**.

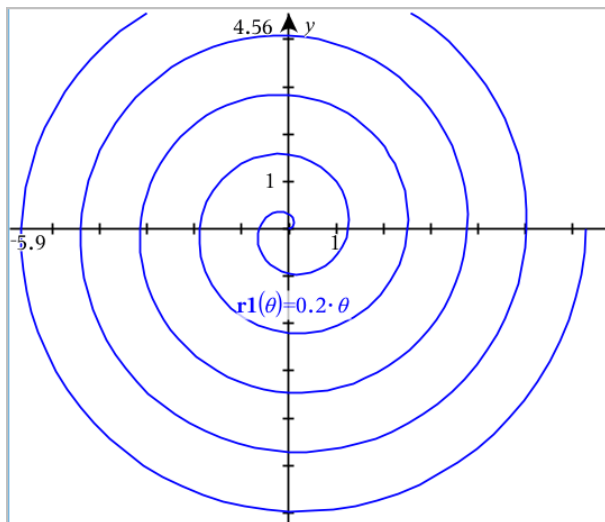

**Note:** For information about path plots, see [Exploring Graphs with Path Plot](#).

### Graphing Scatter Plots

- (Optional) Create two predefined list variables containing the x and y values to plot. You can use the Lists & Spreadsheet, Calculator, or Notes application to create the lists.

A v1	B v2	C	D
1	2		
2	4		
3	8		
4	16		
5	32		

- From the **Graph Entry/Edit** menu, select **Scatter Plot**.

Use the up and down arrow keys to move between the x and y fields.

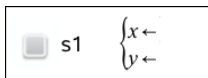

3. Use one of the following methods to specify lists to plot as x and y.
  - Click  to select names of the predefined list variables.
  - Type the names of the variables, such as  $v1$ .
  - Type lists as comma-separated elements enclosed within brackets, for example:  $\{1,2,3\}$ .

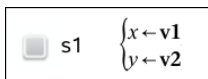

4. Press **Enter** to plot the data, and then [zoom the work area](#) to view the plotted data.

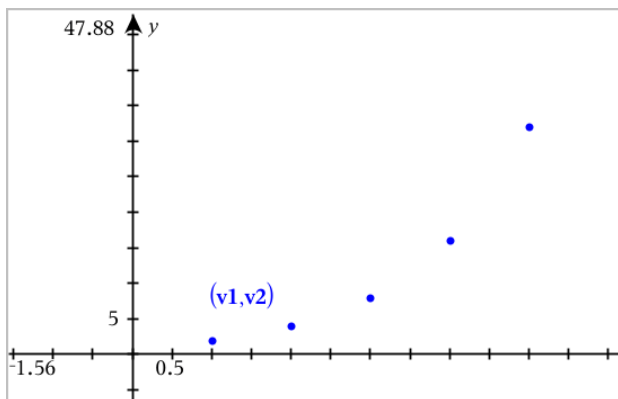

## Plotting Sequences

The Graphs application lets you plot two types of sequences. Each type has a separate template for defining the sequence.

### Defining a Sequence

1. From the **Graph Entry/Edit** menu, select **Sequence > Sequence**.

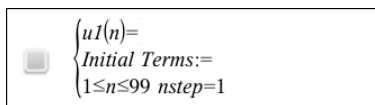

2. Type the expression to define the sequence. Update the independent variable field to  $m+1$ ,  $m+2$ , etc., if necessary.
3. Type an initial term. If the sequence expression references more than one prior term, such as  $u1(n-1)$  and  $u1(n-2)$ , (or  $u1(n)$  and  $u1(n+1)$ ), separate the terms with commas.



$$\begin{cases} u1(n)=1.1 \cdot u1(n-1)+1 \\ \text{Initial Terms}:=1 \\ 1 \leq n \leq 99 \quad n\text{step}=1 \end{cases}$$

4. Press **Enter**.

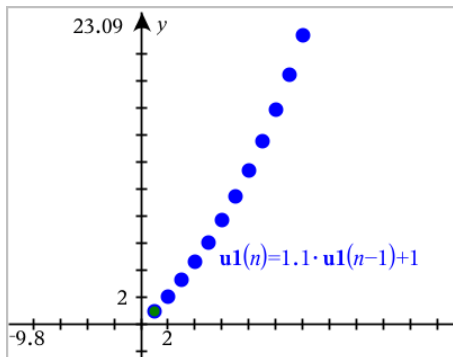

### Defining a Custom Sequence

A custom sequence plot shows the relationship between two sequences by plotting one on the x axis and the other on the y axis.

This example simulates the Predator-Prey model from biology.

1. Use the relations shown here to [define two sequences](#): one for a rabbit population, and another for a fox population. [Replace the default sequence names](#) with **rabbit** and **fox**.



$$\begin{cases} \mathbf{rabbit}(n)=\mathbf{rabbit}(n-1) \cdot (1+0.05-0.001 \cdot \mathbf{fox}(n-1)) \\ \text{Initial Terms}:=200 \\ 1 \leq n \leq 400 \quad n\text{step}=1 \end{cases}$$



$$\begin{cases} \mathbf{fox}(n)=\mathbf{fox}(n-1) \cdot (1+2.E-4 \cdot \mathbf{rabbit}(n-1)-0.03) \\ \text{Initial Terms}:=50 \\ 1 \leq n \leq 400 \quad n\text{step}=1 \end{cases}$$

.05 = the growth rate of rabbits if there are no foxes

.001 = the rate at which foxes can kill rabbits

.0002 = the growth rate of foxes if there are rabbits

.03 = the death rate of foxes if there are no rabbits

**Note:** If you want to see the plots of the two sequences, [zoom the window](#) to the **Zoom - Fit** setting.

2. From the **Graph Entry/Edit** menu, select **Sequence > Custom**.
3. Specify the **rabbit** and **fox** sequences to plot on the x and y axes, respectively.

p1  $\begin{cases} x \leftarrow \text{rabbit}(n) \\ y \leftarrow \text{fox}(n) \\ 1 \leq n \leq 400 \text{ nstep}=1 \end{cases}$

4. Press **Enter** to create the custom plot.
5. [Zoom the window](#) to the **Zoom - Fit** setting.

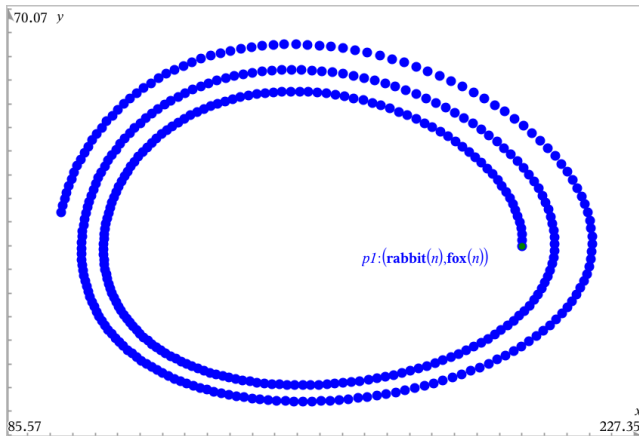

6. Explore the custom plot by dragging the point that represents the initial term.

### Graphing Differential Equations

You can study linear and non-linear differential equations and systems of ordinary differential equations (ODEs), including logistic models and Lotka-Volterra equations (predator-prey models). You can also plot slope and direction fields with interactive implementations of Euler and Runge-Kutta methods.

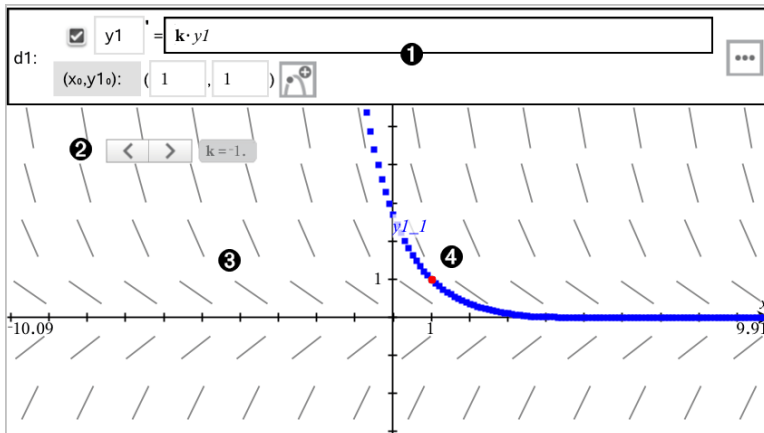

- 1 ODE entry line:
  - **y1** ODE identifier
  - Expression **k·y1** defines the relation
  - Fields **(1,1)** for specifying initial condition
  - Buttons for adding initial conditions and setting plot parameters
- 2 Slider to vary coefficient **k** of the ODE
- 3 Slope field
- 4 A solution curve passing through the initial condition

### To Graph a Differential Equation:

1. From the **Graph Entry/Edit** menu, select **Diff Eq.**

The ODE is automatically assigned an identifier, such as “y1.”

2. Move to the relation field and enter the expression that defines the relation. For example, you might enter  $-y1+0.1 \cdot y1 \cdot y2$ .

3. Enter the initial condition for the independent value  $x_0$  and for  $y1_0$ .

**Note:** The  $x_0$  value(s) are common to all the ODEs in a problem but can be entered or modified only in the first ODE.

4. (Optional) To study multiple initial conditions for the current ODE, click Add Initial Conditions  and enter the conditions.

5. Tap Edit Parameters  to set the plot parameters. Select a numerical Solution Method, and then set any additional parameters. You can change these parameters anytime.

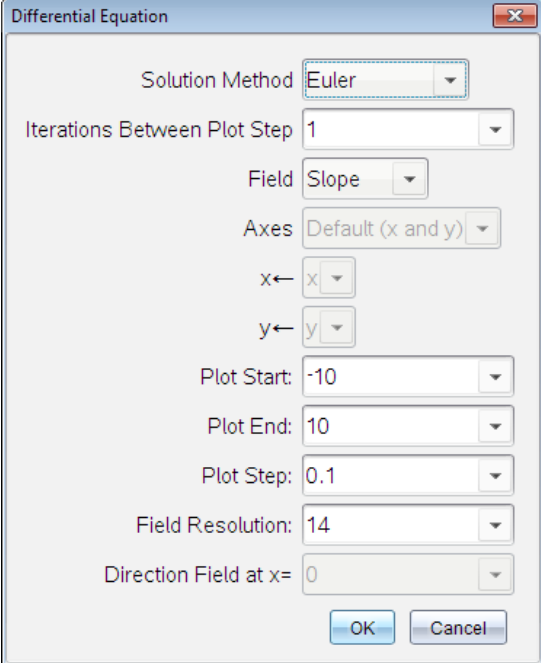

6. Click **OK**.
7. To enter additional ODEs, press the down arrow to display the next ODE edit field.

As you move among defined ODEs, the graph is updated to reflect any changes. One solution to the ODE is graphed for each IC specified for each shown ODE (selected by check box).

### Summary of Differential Equation Settings

<b>Solution Method</b>	Selects Euler or Runge-Kutta as the numerical solution method.
<b>Iterations Between Plot Step</b>	Computational accuracy for Euler solution method only. Must be an integer value $>0$ . To restore the default, select the down-arrow and select <b>Default</b> .
<b>Error Tolerance</b>	Computational accuracy for Runge-Kutta solution method only. Must be a floating-point value $\geq 1 \times 10^{-14}$ . To restore the default, select the down-arrow and select <b>Default</b> .

<b>Field</b>	<p><b>None</b> - No field is plotted. Available for any number of ODEs, but required if three or more 1st-order ODEs are active. Graphs a combination of the solution and/or values of one or more ODEs (according to user-configured <b>Axes</b> settings).</p> <p><b>Slope</b> - Plots a field representing the family of solutions to a single 1st-order ODE. Exactly one ODE must be active. Sets <b>Axes</b> to <b>Default (x and y)</b>. Sets Horizontal axis to x (the independent variable). Sets Vertical axis to y (the solution to the ODE).</p> <p><b>Direction</b> - Graphs a field in the phase plane representing the relationship between a solution and/or values of a system of two 1st-order ODEs (as specified by the <b>CustomAxes</b> setting). Exactly two ODEs must be active.</p>
<b>Axes</b>	<p><b>Default (x and y)</b> - Plots x on the x axis and y (the solutions to the active differential equations) on the y axis.</p> <p><b>Custom</b> - Lets you select the values to be plotted on the x and y axes respectively. Valid entries include:</p> <ul style="list-style-type: none"> <li>• x (the independent variable)</li> <li>• y1, y2, and any identifiers defined in the ODE editor</li> <li>• y1', y2', and any derivatives defined in the ODE editor</li> </ul>
<b>Plot Start</b>	Sets the independent variable value at which the solution plot starts.
<b>Plot End</b>	Sets the independent variable value at which the solution plot stops.
<b>Plot Step</b>	Sets the increment of the independent variable at which values are plotted.
<b>Field Resolution</b>	Sets the number of columns of field rendering elements (line segments) used to draw a slope or direction field. You can change this parameter only if <b>Field = Direction</b> or <b>Slope</b> .
<b>Direction Field at x=</b>	Sets the independent variable value at which a direction field is drawn when plotting non-autonomous equations (those that refer to x). Ignored when plotting autonomous equations. You can change this parameter only if <b>Field = Direction</b> .

## Viewing Tables from the Graphs Application

You can show a table of values for any relation defined in the current problem.

**Note:** For details about using tables and instructions for accessing tables from the Lists & Spreadsheet application, see [Working with Tables](#).

### Showing a Table

► From the **Table** menu, select **Split-screen Table**.

The table is displayed with columns of values for the currently defined relations.



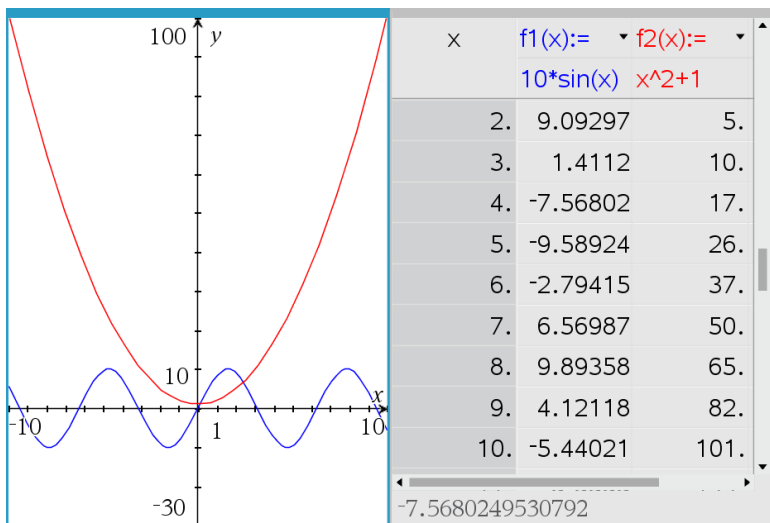

To change which relation is displayed in a column, click the arrow in the top cell of the column, and then select the relation name.

### Hiding the Table

- ▶ From the **Table** menu, select **Remove Table**.

### Editing Relations

1. Double-click the graph to show its expression in the entry line.  
—or—  
Display the graph's context menu, and then click **Edit Relation**.

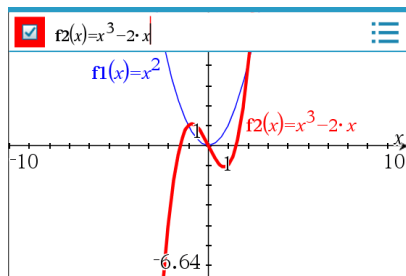

2. Modify the expression as needed.



3. Press **enter** to graph the revised function.

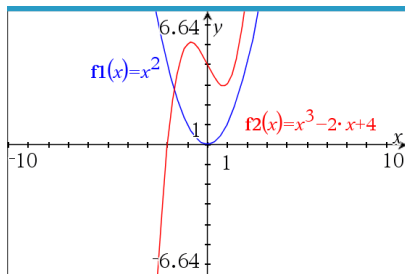

## Renaming a Relation

Each relation type has a default naming convention. For example, the default name for functions is  $f_n(x)$ . (The number represented by  $n$  increases as you create more functions.) You can replace the default name with a name of your choice.

**Note:** If you want to use a custom name as a convention, you must enter it manually for each function.

1. In the entry line, delete the existing name. For example, delete the " $f1$ " from " $f1(x)$ ". You can use the right and left arrow keys to position the cursor.

2. Type the replacement name.

3. If you are defining a new relation, position the cursor after the = sign and type the expression.

4. Press **Enter** to graph the relation with its new name.

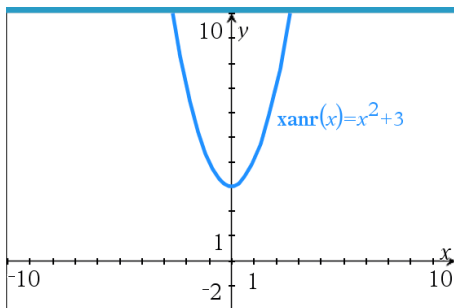

## Accessing the Graph History

For each problem, the software stores a history of relations defined in the Graphs application and 3D Graphing view, such as function graphs **f1** through **f99** and 3D

function graphs **z1** through **z99**. You can view and edit these items using a button on the entry line.

### Viewing the History

1. Press **Ctrl+G** to show the entry line.
2. Click the **History Menu** button  on the entry line.

The menu is displayed. As you point to the name of each item, its expression appears in the entry line.

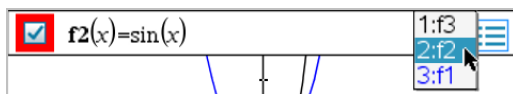

3. Select the name of the relation you want to view or edit.
4. (Optional) From the entry line, use the up and down arrow keys to scroll through the defined relations of the same type.

### Viewing the History of Specific Relation Types

Use this method if you want to view or edit a defined relation that does not appear in the History menu.

1. On the **Graph Entry/Edit** menu, click the relation type. For example, click **Polar** to show the entry line for the next available Polar relation.
2. Click the **History Menu** button , or use the up and down arrow keys to scroll through the defined relations of the same type.

## Zooming/Rescaling the Graphs Work Area

Rescaling in the Graphs application affects only the graphs, plots and objects that reside in the Graphing view. It has no effect on objects in the underlying Plane Geometry view.

### Rescaling by Dragging Along an Axis

- ▶ To rescale the x and y axes proportionally, drag a k mark on either axis.
- ▶ To rescale only one axis, hold down **Shift** and drag a k mark on the axis.

### Zooming Using a Zoom Tool

- ▶ From the **Window / Zoom** menu, select one of the tools.
  - **Zoom - Box** (Click two corners of a box to define the area to show.)
  - **Zoom - In**
  - **Zoom - Out**

### Zooming to Predefined Settings

- ▶ From the **Window / Zoom** menu, select one of the predefined Zoom settings.

- Zoom - Standard
- Zoom - Quadrant 1
- Zoom - Standard User
- Zoom - Standard Trig
- Zoom - Standard Data
- Zoom - Fit

### Entering Custom Window Settings

1. From the **Window / Zoom** menu, select **Window Settings**.
2. Enter a value for each setting. You can use expressions for exact input, as shown below.

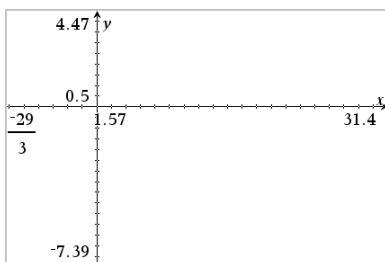

*On TI-Nspire™ products, fractional input is preserved as-is. Other exact inputs are replaced with the evaluated result.*

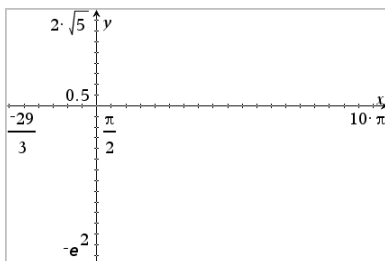

*On TI-Nspire™ Exact Arithmetic and CAS products, fractional and other exact inputs are preserved.*

## Customising the Graphs Work Area

### Inserting a Background Image

You can [insert an image](#) as a background for any Graphs or Geometry page.

1. From the **Insert** menu, click **Image**.
2. Navigate to the image you want to insert, select it and then click **Open**.

### Adding a Text Object to the Work Area

Use the Text tool to add numeric values, formulas, observations or other explanatory information to the Graphs work area. You can graph an equation entered as text (such as "x=3").

1. From the **Actions** menu, select **Text**.
2. Click the location for the text.
3. Type the text in the box that appears, and then press **Enter**.

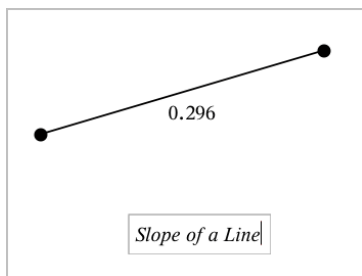

To move a text object, drag it. To edit the text, double-click it. To delete a text object, display its context menu, and select **Delete**.

### Changing the Attributes of Numeric Text

If you enter a numeric value as text, you can lock it or set its format and displayed precision.

1. From the **Actions** menu, select **Attributes**.
2. Click the numeric text to display its list of attributes.
3. Press **▲** and **▼** to move through the list.
4. At each attribute icon, press **◀** or **▶** to move through the options. For example, select **0** through **9** as the precision.
5. Press **Enter** to apply the changes.
6. Press **Esc** to close the Attributes tool.

### Displaying the Grid

By default, the grid is not displayed. You can choose to display it as dots or lines.

- From the **View** menu, select **Grid**, and then select **Dot Grid**, **Lined Grid**, or **No Grid**.

## Changing the Grid Colour

1. From the **Actions** menu, choose **Select > Grid** (available only when the grid is displayed).

The grid flashes to show it is selected.

2. Click the down arrow next to the Colour button, and select a colour for the grid.



## Changing the Appearance of the Graph Axes

1. From the **Actions** menu, click **Attributes**.
2. Click either axis.
3. Press **▲** and **▼** to move to the desired attribute, and then press **◀** and **▶** to choose the option to apply.

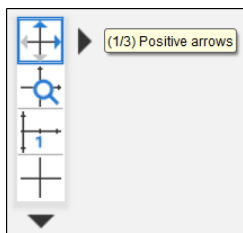

**Note:** To hide the axes or selectively hide or show an individual axis end-value, use the [Hide/Show tool](#).

To display multiple tick mark labels, select the **Multiple Labels** option.

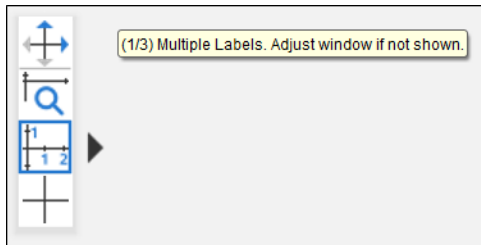

Multiple labels are only displayed if they fit both horizontally and vertically on the axes. If necessary, adjust the values in the **Window / Zoom > Window Settings** dialogue.

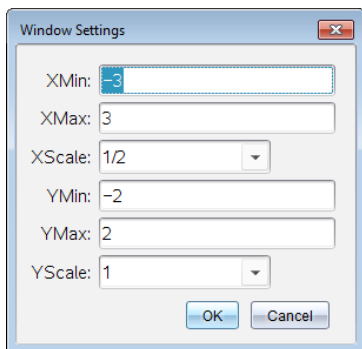

Window Settings

XMin: -3

XMax: 3

XScale: 1/2

YMin: -2

YMax: 2

YScale: 1

OK Cancel

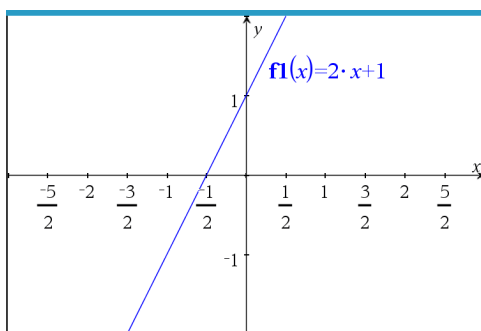

**Exact Arithmetic and CAS Only:** You can change the tick mark labels to display multiples of Pi, radical numbers, and other exact values by editing the **XScale** or **YScale** values in the **Window / Zoom > Window Settings** dialogue. See the following example.

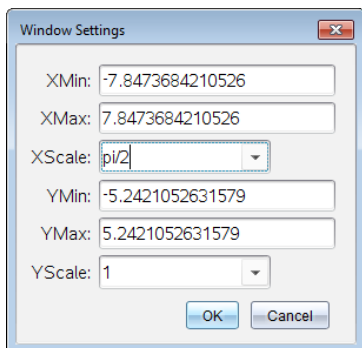

Window Settings

XMin: -7.8473684210526

XMax: 7.8473684210526

XScale:  $\pi/2$

YMin: -5.2421052631579

YMax: 5.2421052631579

YScale: 1

OK Cancel

**Note:**  $\pi/2$  will be converted to  $\pi/2$  after clicking **OK**.

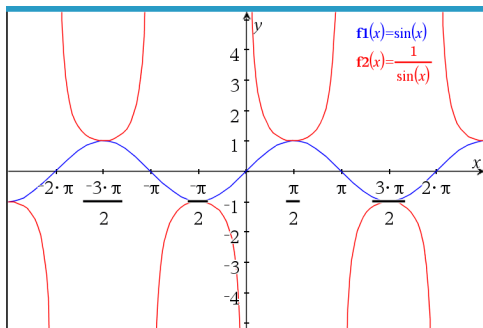

**Note:** For information about path plots, see [Exploring Graphs with Path Plot](#).

### ***Hiding and Showing Items in the Graphs Application***

The Hide/Show tool reveals objects you have previously selected as hidden and lets you select which objects to show or hide.

**Note:** If you hide a graph, its expression is automatically marked as hidden in the [graph history](#).

1. From the **Actions** menu, select **Hide/Show**.

The Hide/Show tool appears at the top of the work area, and currently hidden items (if any) are shown dimmed.

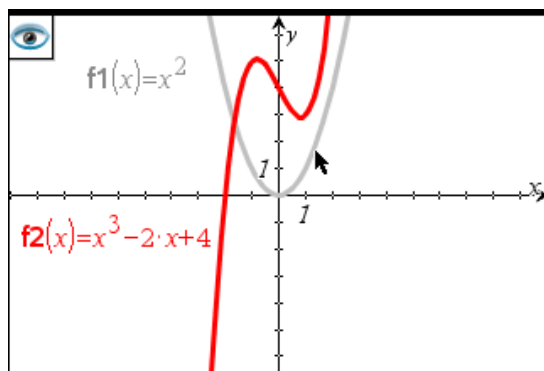

2. Click objects to toggle their hide/show status. You can hide graphs, geometric objects, text, labels, measurements, and individual axis end-values.
3. Press **Esc** to complete your selections and close the tool.

All objects you selected as hidden objects disappear.



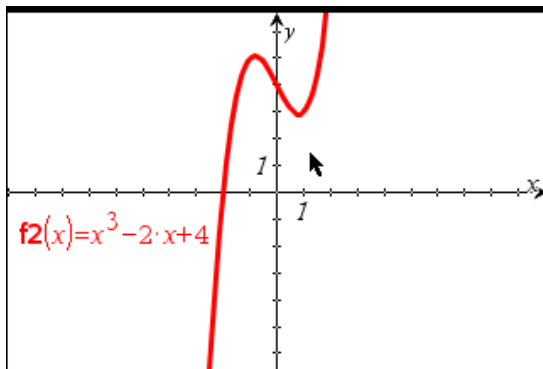

- To view the hidden objects temporarily or restore them as shown objects, open the Hide/Show tool.

### **Conditional Attributes**

You can cause objects to hide, show, and change colour dynamically, based on specified conditions such as " $r_1 < r_2$ " or " $\sin(a_1) \geq \cos(a_2)$ ".

For example, you might want to hide an object based on a changing measurement that you have assigned to a variable, or you might want an object's colour to change based on a "Calculate" result assigned to a variable.

Conditional behaviours can be assigned to objects or groups in the Graphing, Plane Geometry, and 3D Graphing views.

#### **Setting Conditional Attributes of an Object**

You can set conditions of a selected object either by using its context menu or by activating the Set Conditions tool from the **Actions** menu and then selecting the object. These instructions describe using the context menu.

- Select the object or group.
- Display the object's context menu, and click **Conditions**.

The conditional attributes are displayed.

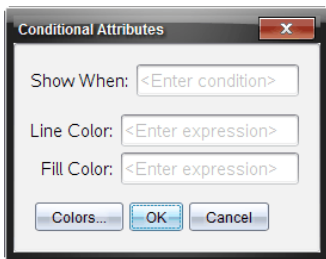

For 2D objects

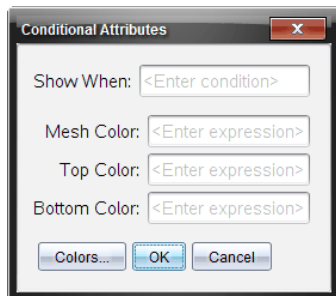

For 3D objects

- (Optional) In the **Show When** field, enter an expression specifying the conditions during which the object will be shown. Anytime the condition is not satisfied, the object will be hidden.

You can specify tolerance by using compound conditionals in the **Show When** input field. For example, **area**>=4 **and** **area**<=6.

**Note:** If you need to see conditionally hidden objects temporarily, click **Actions > Hide/Show**. To return to normal viewing, press **ESC**.

- (Optional) Enter numbers or expressions that evaluate to numbers in the applicable colour fields, such as **Line Colour** or **Mesh Colour**. To see a map of colour values, click the **Colors** button.

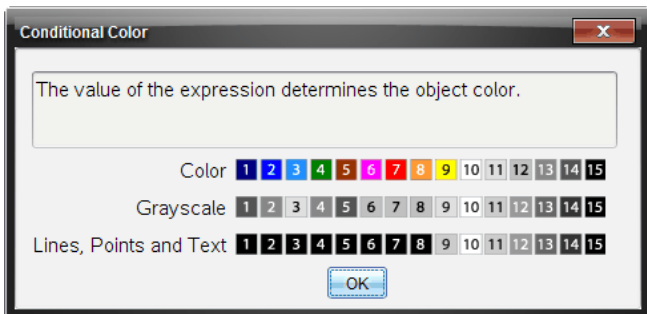

Map of conditional colour values

- Click **OK** in the Conditional Attributes dialogue box to apply the conditions.

## Calculating a Bounded Area

**Note:** To avoid unexpected results when using this feature, make sure the [document setting](#) for "Real or Complex Format" is set to **Real**.

When you calculate the area between curves, each curve must be:

- A function with respect to  $x$ .  
- or -
- An equation in the form  $y=$ , including  $y=$  equations defined through a text box or a conic equation template.

### Defining and Shading the Area

1. From the **Analyse Graph** menu, select **Bounded Area**.

If exactly two appropriate curves are available, they are selected automatically, and you can skip to step 3. Otherwise, you are prompted to select two curves.

2. Click two curves to select them.  
- or -  
Click one curve and the  $x$  axis.

You are prompted to set the lower and upper bounds.

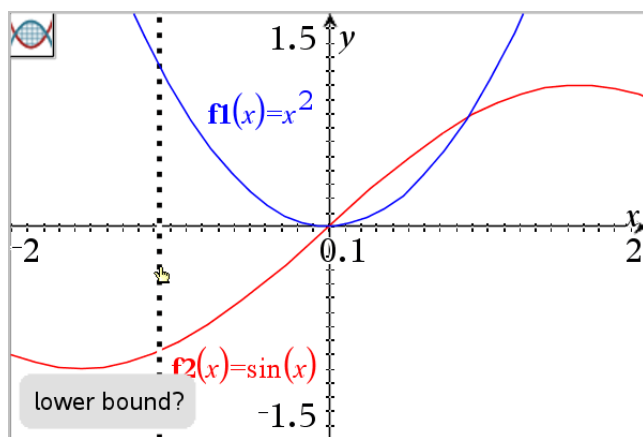

3. Click two points to define the bounds. Optionally, you can type numeric values.

The area becomes shaded, and the area value is displayed. The value is always non-negative, regardless of the interval direction.

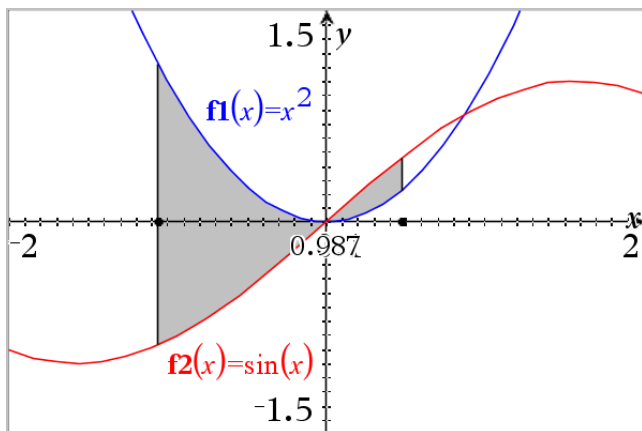

### Working with Shaded Areas

As you change the bounds or redefine the curves, the shading and the area value are updated.

- To change the lower or upper bound, drag it or type new coordinates for it. You cannot move a bound that resides on an intersection. However, the point moves automatically as you edit or manipulate the curves.
- To redefine a curve, either manipulate it by dragging or edit its expression in the entry line.

If an endpoint resided originally on an intersection, and the redefined functions no longer intersect, the shading and area value disappear. If you redefine the function (s) so that there is an intersection point, the shading and area value reappear.

- To delete or hide the shaded area, or to change its colour and other attributes, display its context menu.
  - Windows®: Right-click the shaded area.
  - Mac®: Hold  $\mathcal{H}$  and click the shaded area.
  - Handheld: Move the pointer to the shaded area and press **ctrl** .

### Tracing Graphs or Plots

Graph Trace lets you move a trace cursor over the points of a graph or plot and displays value information.

#### Tracing Specific Graphs

1. From the **Trace** menu, select **Graph Trace**.

The Graph Trace tool appears at the top of the work area, the trace cursor appears, and the cursor coordinates are displayed in the lower right corner.

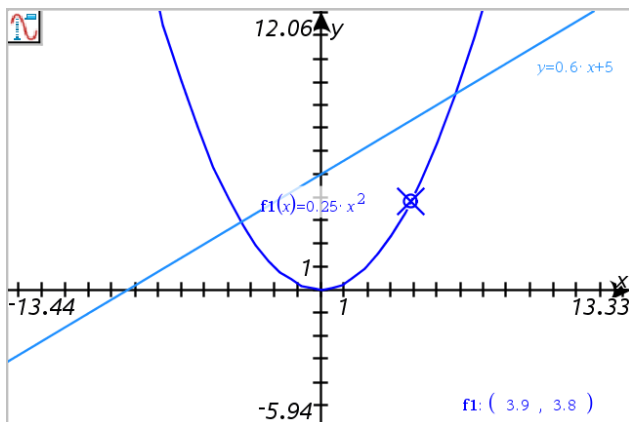

2. Explore a graph or plot:

- Point to a position on a graph or plot to move the trace cursor to that point.
- Press ◀ or ▶ to step the cursor along the current graph or plot. The screen pans automatically to keep the cursor in view.
- Press ▲ or ▼ to cycle among the displayed graphs.
- Click the trace cursor to create a persistent point. Optionally, enter a specific independent value to move the trace cursor to that value.

3. To stop tracing, press Esc.

### Tracing All Graphs

The Trace All tool allows tracing multiple functions simultaneously. With several functions graphed on the work area, perform the following steps:

**Note:** The Trace All tool traces only function graphs, not plots of other relations (polar, parametric, scatter, sequence).

1. From the **Trace** menu, select **Trace All**.

The Trace All tool appears in the work area, a vertical line indicates the x value of the trace, and the coordinates for each traced point are displayed in the lower right corner.

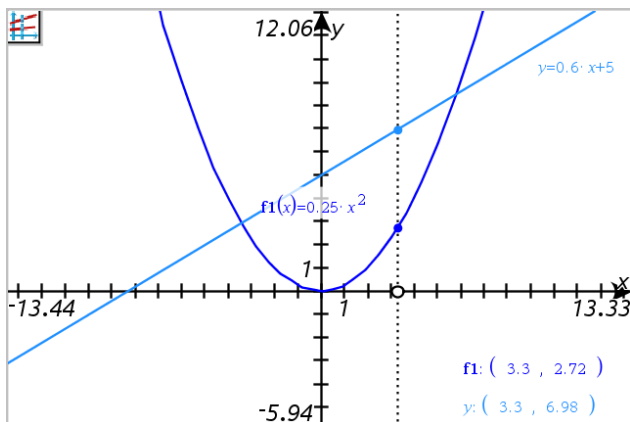

2. Explore the graphs:
  - Click a point on the x axis to move all the trace points to that x value.
  - Press ◀ or ▶ to step the trace points along all the graphs.
3. To stop tracing, press Esc.

### Changing the Trace Step

1. From the **Trace** menu, select **Trace Step**.

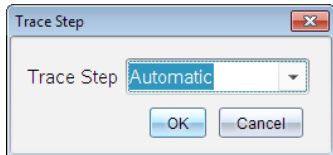

2. Choose Automatic or enter a specific step size for tracing.

### ***Introduction to Geometric Objects***

Geometry tools are accessible in both the Graphs and Geometry applications. You can use these tools to draw and investigate objects such as points, lines, and shapes.

- The Graphing view shows the Graphs work area superimposed on the Geometry work area. You can select, measure, and alter objects in both work areas.
- The Plane Geometry view shows only the objects created in the Geometry application.

## Objects Created in the Graphs Application

Points, lines, and shapes created in the Graphs application are analytic objects.

- All points that define these objects reside on the x,y graph plane. Objects created here are visible only in the Graphs application. Changing the axes scale affects the appearance of the objects.
- You can display and edit the coordinates of any point on an object.
- You can display the equation of a line, tangent line, circle shape, or geometric conic created in the Graphs application.

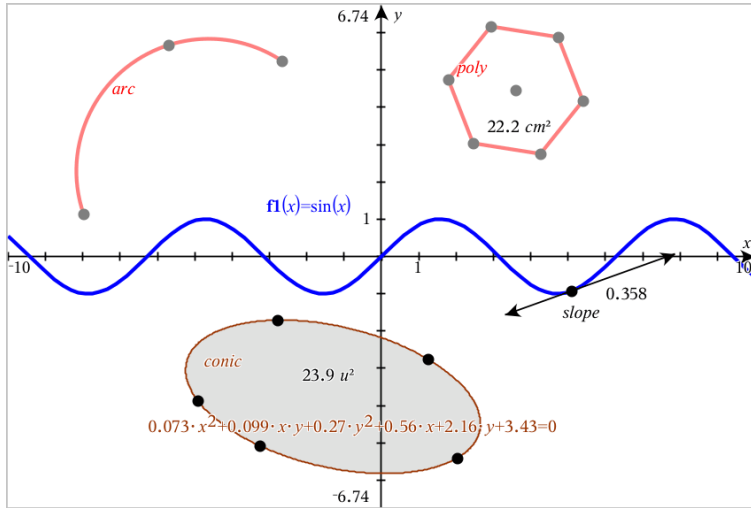

The circle arc and polygon were created in the Geometry application. The sine wave and conic were created in the Graphs application.

## Objects Created in the Geometry Application

Points, lines, and shapes created in the Geometry application are not analytic objects.

- Points that define these objects do not reside on the graph plane. Objects created here are visible in both the Graphs and Geometry applications, but they are unaffected by changes to the Graphs x,y axes.
- You cannot obtain the coordinates of an object's points.
- You cannot display the equation of a geometric object created in the Geometry application

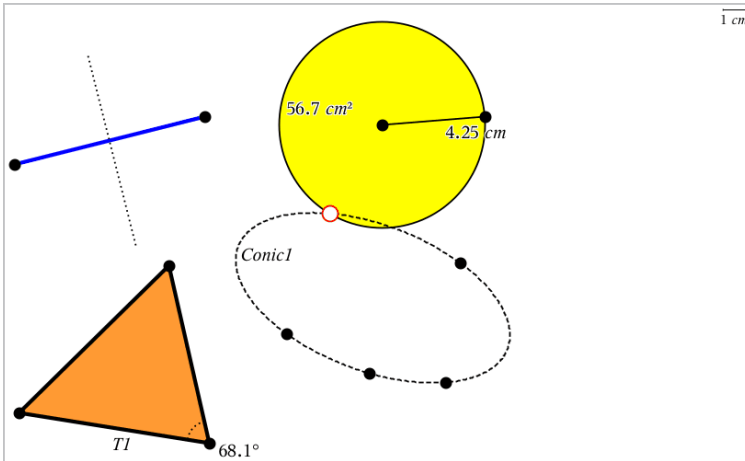

## Creating Points and Lines

As you create an object, a tool appears in the work area (for example, **Segment** ). To cancel, press **ESC**. To enable automatic labeling of certain objects, see *What You Must Know* in this chapter.

### Creating a Point on the Work Area

1. From the **Points and Lines** menu, select **Point**. (In the Graphs application, click **Geometry > Points and Lines > Point**.)
2. Click a location to create the point.
3. (Optional) Label the point.
4. To move a point, drag it.

### Creating a Point on a Graph or Object

You can create a point on a line, segment, ray, axis, vector, circle, graph or axis.

1. From the **Points and Lines** menu, select **Point On**. (In the Graphs application, click **Geometry > Points and Lines > Point On**.)
2. Click the graph or object on which you want to create the point.
3. Click a location on the object to place the point.



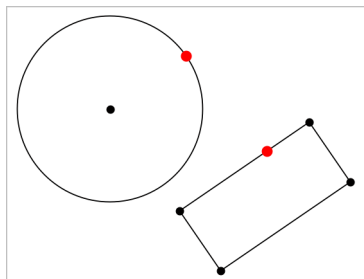

## Creating a Dynamic Point on a Graph

You can create a dynamic point on a graph with Point by Coordinates.

1. From the **Points and Lines** menu, select **Point by Coordinates**. (In the Graphs application, click **Geometry > Points and Lines > Point by Coordinates** or press **P** and select **Point by Coordinates**).

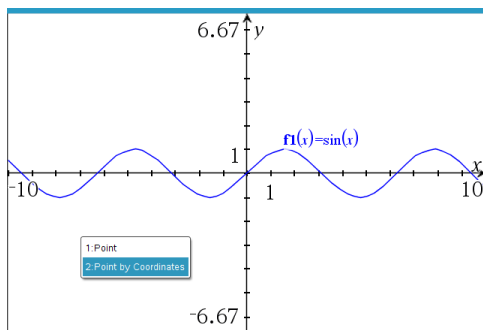

2. Enter the variables or expressions for one or both of the coordinates.

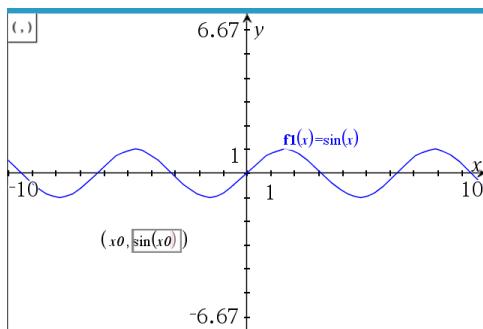

3. Use the slider that is created to move the point on the graph.

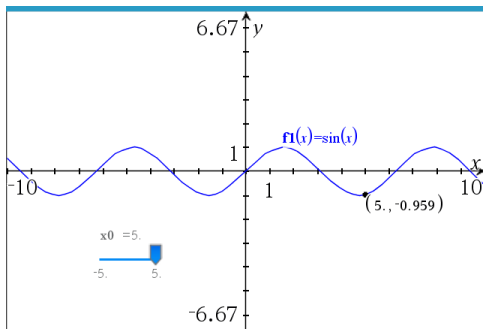

The point will display the actual coordinates. If you hover the cursor over a coordinate, it will display the variable or expression.

To edit the point, double-click the coordinate on the label. Any variable or expression that was entered before is retained.

### Identifying Points of Intersection

1. From the **Points and Lines** menu, select **Intersection Points**. (In the Graphs application, click **Geometry > Points and Lines > Intersection Points**.)
2. Click two intersecting objects to add points at their intersections.

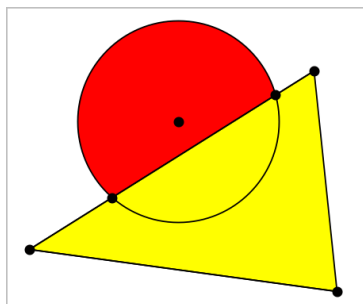

### Creating a Line

1. From the **Points and Lines** menu, select **Line**. (In the Graphs application, click **Geometry > Points and Lines > Line**.)
2. Click a location to define one point on the line.
3. Click a second location to define the direction of the line and the length of its visible portion.

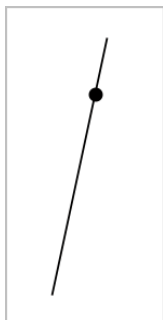

4. To move a line, drag its identifying point. To rotate it, drag any point except the identifying point or ends. To extend its visible portion, drag from either end.

### Creating a Segment

1. From the **Points and Lines** menu, select **Segment**. (In the Graphs application, click **Geometry > Points and Lines > Segment**.)
2. Click two locations to define the endpoints of the segment.



3. To move a segment, drag any point other than an endpoint. To manipulate the direction or length, drag either endpoint.

### Creating a Ray

1. From the **Points and Lines** menu, select **Ray**. (In the Graphs application, click **Geometry > Points and Lines > Ray**.)
2. Click a location to define the endpoint of the ray.
3. Click a second location to define the direction.

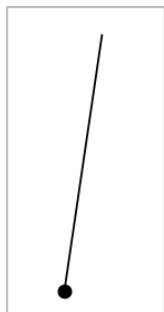

To move a ray, drag its identifying point. To rotate it, drag any point except the identifying point or end. To extend its visible portion, drag from the end.

### Creating a Tangent

You can create a tangent line at a specific point on a geometric object or function graph.

1. From the **Points and Lines** menu, select **Tangent**. (In the Graphs application, click **Geometry > Points and Lines > Tangent**.)
2. Click the object to select it.
3. Click a location on the object to create the tangent.

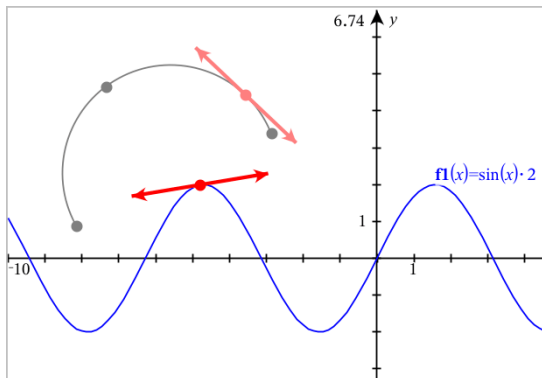

4. To move a tangent, drag it. It remains attached to the object or graph.

### Creating a Vector

1. From the **Points and Lines** menu, select **Vector**. (In the Graphs application, click **Geometry > Points and Lines > Vector**.)

2. Click a location to establish the vector's initial point.
3. Click a second location to specify direction and magnitude and complete the vector.

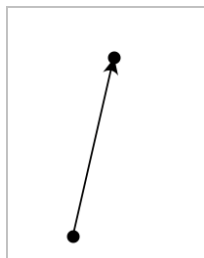

4. To move a vector, drag any point other than the endpoints. To manipulate the magnitude and/or direction, drag either end point.

**Note:** If you create an endpoint on an axis or another object, you can move the endpoint only along that object.

### Creating a Circle Arc

1. From the **Points and Lines** menu, select **Circle Arc**. (In the Graphs application, click **Geometry > Points and Lines > Circle Arc**.)
2. Click a location or point to establish the starting point of the arc.
3. Click a second point to establish an intermediate point through which the arc will pass.
4. Click a third point to set the ending point and complete the arc.

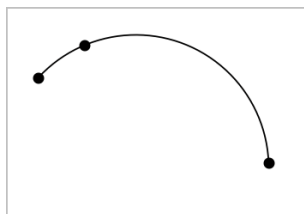

5. To move an arc, drag its perimeter. To manipulate it, drag any of its three defining points.

### Creating Geometric Shapes

The Shape tools let you explore circles, polygons, conics and other geometric objects.

As you create a shape, a tool appears in the work area (for example, **Circle** ). To cancel the shape, press **ESC**. To enable automatic labelling of certain objects, see *What You Must Know*, in this chapter.

### Creating a Circle

1. From the **Shapes** menu, select **Circle**. (In the Graphs application, click **Geometry > Shapes > Circle**.)
2. Click a location or point to position the circle's centre point.
3. Click a location or point to establish the radius and complete the circle.

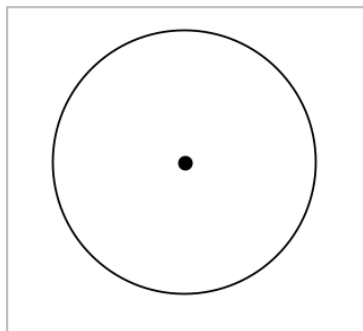

4. To resize a circle, drag its perimeter. To move it, drag its centre point.

### Creating a Triangle

**Note:** To ensure that the total of the angles of a triangle equals  $180^\circ$  or 200 gradians, you can force integer angles in the Geometry view. Refer to *What You Must Know*, in this chapter.

1. From the **Shapes** menu, select **Triangle**. (In the Graphs application, click **Geometry > Shapes > Triangle**.)
2. Click three locations to establish the vertices of the triangle.

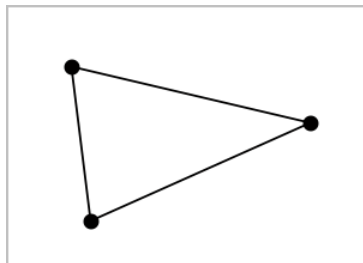

3. To manipulate a triangle, drag any point. To move it, drag any side.

### Creating a Rectangle

1. From the **Shapes** menu, select **Rectangle**. (In the Graphs application, click **Geometry > Shapes > Rectangle**.)

2. Click a location or point to establish the first corner of the rectangle.

3. Click a location for the second corner.

One side of the rectangle is displayed.

4. Click to establish the distance to the opposite side and complete the rectangle.

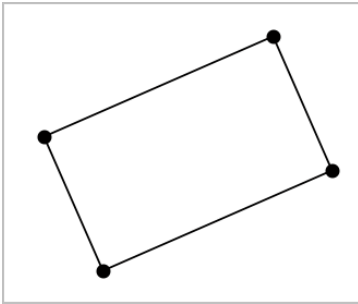

5. To rotate a rectangle, drag one of its first two points. To extend it, drag one of the last two points. To move it, drag any side.

### Creating a Polygon

1. From the **Shapes** menu, select **Polygon**. (In the Graphs application, click **Geometry > Shapes > Polygon**.)

2. Click a location or point to establish the first vertex of the polygon.

3. Click to establish each additional vertex.

4. To complete the polygon, click the first vertex.

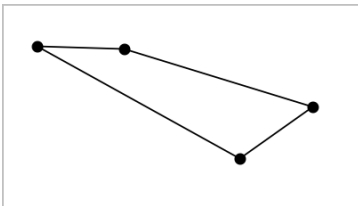

5. To manipulate a polygon, drag any vertex. To move it, drag any side.

## Creating a Regular Polygon

1. From the **Shapes** menu, select **Regular Polygon**. (In the Graphs application, click **Geometry > Shapes > Regular Polygon**.)
2. Click once on the work area to establish the centre point.
3. Click a second location to establish the first vertex and radius.

A 16-sided regular polygon is formed. The number of sides is displayed in brackets; for example, {16}.

4. Drag any vertex in a circular motion to set the number of sides.
  - Drag clockwise to reduce the number of sides.
  - Drag counter-clockwise to add diagonals.

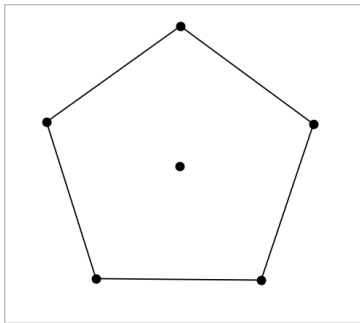

5. To resize or rotate a regular polygon, drag any of its points. To move it, drag any side.

## Creating an Ellipse

1. From the **Shapes** menu, select **Ellipse**. (In the Graphs application, click **Geometry > Shapes > Ellipse**.)
2. Click two locations or points to establish the foci.
3. Click to establish a point on the ellipse and complete the shape.

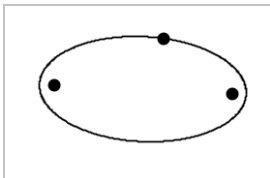



4. To manipulate an ellipse, drag any of its three defining points. To move it, drag its perimeter.

### Creating a Parabola (from focus and vertex)

1. From the **Shapes** menu, select **Parabola**. (In the Graphs application, click **Geometry > Shapes > Parabola**.)
2. Click a location to establish the focus.
3. Click a location to establish the vertex and complete the parabola.

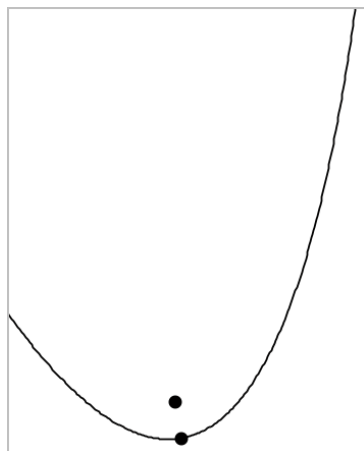

4. To manipulate a parabola, drag its focus or its vertex. To move it, drag it from any other point.

### Creating a Parabola (from focus and directrix)

1. Create a line to serve as the directrix.
2. From the **Shapes** menu, select **Parabola**. (In the Graphs application, click **Geometry > Shapes > Parabola**.)
3. Click a location to establish the focus.
4. Click the line to establish it as the directrix.

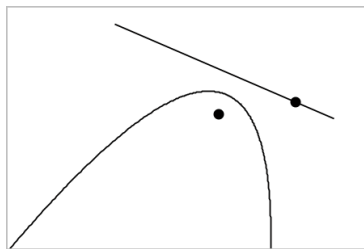

5. To manipulate a parabola, rotate or move its directrix or drag its focus. To move it, select both the directrix and the focus, and then drag either object.

### Creating a Hyperbola

1. From the **Shapes** menu, select **Hyperbola**. (In the Graphs application, click **Geometry > Shapes > Hyperbola**.)
2. Click two locations to establish the foci.
3. Click a third location to complete the hyperbola.

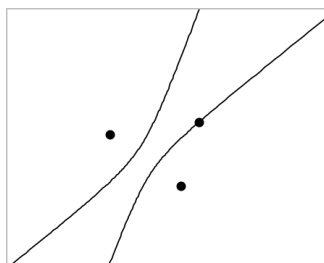

4. To manipulate a hyperbola, drag any of its three defining points. To move it, drag it from any other place on the shape.

### Creating a Conic by Five Points

1. From the **Shapes** menu, select **Conic by Five Points**. (In the Graphs application, click **Geometry > Shapes > Conic by Five Points**.)
2. Click five locations to establish the five points on the shape.

Depending on the pattern of the points, the conic can be a hyperbola or an ellipse.

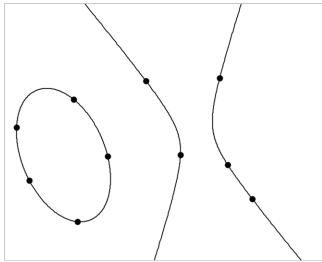

3. To manipulate a conic, drag any of its five defining points. To move it, drag it from any other place on the shape.

### ***Creating Shapes Using Gestures (MathDraw)***

The MathDraw tool lets you use touchscreen or mouse gestures to create points, lines, circles and other shapes.

MathDraw is available in:

- Geometry view without the analytic window displayed.
- Graphing view when the x scale and y scale are identical. This avoids non-circular ellipses and non-square rectangles appearing as circles and squares.

MathDraw is not available in the 3D Graphing view or in the Geometry view with the analytic window displayed.

#### **Activating MathDraw**

1. If using the Geometry view with the analytic window visible, use the **View** menu to hide the window.
2. On the **Actions** menu, select **MathDraw**.

The MathDraw icon  appears. You can begin using the tool.

#### **Cancelling MathDraw**

- ▶ When you have finished using the MathDraw tool, press **Esc**.

The tool also closes if you select a different tool or change views.

#### **Creating Points**

To create a labelled point, tap or click in an open area.

- If the point is close to an existing line, segment, ray, geometric conic (including circles) or polygon, the point snaps to that object. You can also place a point on the intersection of any two of those types of objects.

- If the point is close to a visible grid location in a Graphs view or the analytic window of a Geometry view, it snaps to the grid.

### Drawing Lines and Segments

To create a line or segment, touch or click the initial position, and then drag to the end position.

- If the drawn line passes near an existing point, the line snaps to the point.
- If the drawn line starts close to an existing point and ends next to another existing point, it becomes a segment defined by those points.
- If the drawn line is nearly parallel or perpendicular to an existing line, segment or side of a polygon, it aligns to that object.

**Note:** The default tolerance for detecting parallel/perpendicular lines is 12.5 degrees. This tolerance can be redefined using a variable named **ti\_gg\_fd.angle\_tol**. You can change the tolerance in the current problem by setting this variable in the calculator app to a value in the range 0 through 45 (0=no parallel/perpendicular detection).

### Drawing Circles and Ellipses

To create a circle or ellipse, use the touchscreen or mouse to draw the approximate shape.

- If the drawn shape is sufficiently circular, a circle is created.
- If the shape is elongated, an ellipse is created.
- If the virtual centre of the drawn shape is near an existing point, the circle or ellipse is centred on that point.

### Drawing Triangles

To create a triangle, draw a triangle-like shape.

- If a drawn vertex is close to an existing point, the vertex snaps to the point.

### Drawing Rectangles and Squares

To create a rectangle or square, use the touchscreen or mouse to draw the perimeter.

- If the drawn shape is nearly square, a square is created.
- If the drawn shape is elongated, a rectangle is created.
- If the centre of a square is close to an existing point, the square snaps to that point.

## Drawing Polygons

To create a polygon, tap or click a succession of existing points, ending on the first point you tapped.

### Using MathDraw to Create Equations

In the Graphs view, MathDraw attempts to recognise certain gestures as functions for analytic parabolas.

**Note:** The default step value for quantisation of the parabola coefficients is  $1/32$ . The denominator of this fraction can be redefined using a variable named **ti\_gg\_fd.par\_quant**. You can change the step value in the current problem by setting this variable to a value greater or equal to 2. A value of 2, for example, produces a step value of 0.5.

### Using MathDraw to Measure an Angle

To measure the angle between two existing lines, use the touchscreen or mouse to draw a circle arc from one of the lines to the other.

- If the intersection point between the two lines does not exist, it is created and labelled.
- The angle is not a directed angle.

### Using MathDraw to Find a Mid-point

To create a point midway between two points, tap or click point 1, point 2, and then point 1 again.

### Using MathDraw to Erase

To erase objects, use the touchscreen or mouse to drag left and right, similar to the motion of erasing a whiteboard.

- The erasure area is the bounding rectangle of the erasure gesture.
- All point objects and their dependents inside the erasure area are removed.

## *Basics of Working with Objects*

### Selecting and Deselecting Objects

You can select an individual object or multiple objects. Select multiple objects when you want to quickly move, colour, or delete them together.

1. Click an object or graph to select it.

The object flashes to indicate selection.

2. Click any additional objects to add them to the selection.
3. Perform the operation (such as moving or setting colour).
4. To deselect all objects, click an empty space in the work area.

### Grouping and Ungrouping Geometric Objects

Grouping objects gives you a way to reselect them as a set, even after you have deselected them to work with other objects.

1. Click each object to add it to the current selection.

The selected objects flash.

2. Display a context menu of the selected object or objects.
3. Click **Group**. You can now select all the items in the group by clicking any of its members.
4. To split a group into individual objects, display a context menu of any of its member objects, and click **Ungroup**.

### Deleting Objects

1. Display the context menu of the object or objects.
2. Click **Delete**.

You cannot delete the origin, the axes, or points representing locked variables, even if those items are included in the selection.

### Moving Objects

You can move an object, group, or combination of selected objects and groups.

**Note:** If an immovable object (such as the graph axes or a point with locked coordinates) is included in a selection or group, you cannot move any of the objects. You must cancel the selection and then select only movable items.

To move this...	Drag this
A multiple-object selection or group	Any of its objects

To move this...	Drag this
A point	The point
A segment or vector	Any point other than an endpoint
A line or ray	The identifying point
A circle	The centre point
Other geometric shapes	Any position on the object except one of its defining points. For example, move a polygon by dragging any of its sides.

### Constraining Object Movement

Holding down the **SHIFT** key before dragging lets you constrain how certain objects are drawn, moved, or manipulated.

Use the constraint feature to:

- Rescale only a single axis in the Graphs application.
- Pan the work area horizontally or vertically, depending on which direction you drag initially.
- Limit object movement to horizontal or vertical.
- Limit point placement to  $15^\circ$  increments as you draw a triangle, rectangle, or polygon.
- Limit angle manipulations to  $15^\circ$  increments.
- Limit the radius of a resized circle to integer values.

### Pinning Objects

Pinning objects prevents accidental changes as you move or manipulate other objects.

You can pin graphed functions, geometric objects, text objects, the graph axes, and the background.

1. Select the object or objects to pin, or click an empty area if you are pinning the background.
2. Display the context menu, and select **Pin**.

A pinned object displays a pin icon  when you point to it.

3. To unpin an object, display its context menu, and select **Unpin**.

**Notes:**

- Although you cannot drag a pinned point, you can reposition it by editing its x and y coordinates.
- You cannot pan the work area while the background is pinned.

**Changing the Line or Fill Colour of an Object**

Colour changes made in the software are displayed in shades of grey when you work on documents using a TI-Nspire™ CX handheld that does not support colour. Colour is preserved when you move documents back to the software.

1. Select the object or objects.
2. Display the object's context menu, click **Colour**, and then click **Line Colour** or **Fill Colour**.
3. Select the colour to apply to the objects.

**Changing the Appearance of an Object**

1. From the **Actions** menu, select **Attributes**.
2. Click the object that you want to change. You can change shapes, lines, graphs, or graph axes.

The list of the attributes for the selected object are displayed.

3. Press **▲** and **▼** to move through the list of attributes.
4. At each attribute icon, press **◀** or **▶** to move through the options. For example, select **Thick**, **Thin**, or **Medium** for the **Line Weight** attribute.
5. Press **Enter** to apply the changes.
6. Press **ESC** to close the **Attributes** tool.

**Labelling Points, Geometric Lines, and Shapes**

1. Display the context menu of the object.
2. Click **Label**.
3. Type the text of the label, and then press **Enter**.

The label attaches itself to the object and follows the object as you move it. The label's colour matches the object's colour.



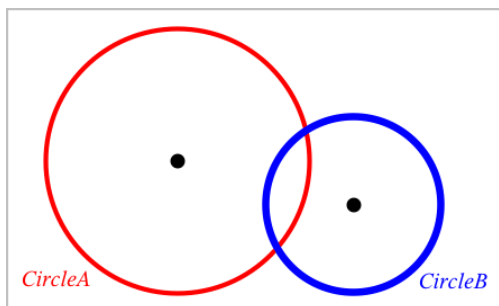

## Measuring Objects

Measurement values update automatically as you manipulate the measured object.

**Note:** Measurements of objects created in the Graphs application are displayed in generic units named  $u$ . Measurements of objects created in the Geometry application are displayed in centimetres ( $cm$ ).

### Measuring Length of a Segment, Circle Arc or Vector

1. From the **Measurement** menu, select **Length**. (In the Graphs application, click **Geometry > Measurement > Length**.)
2. Click the object to display its length.

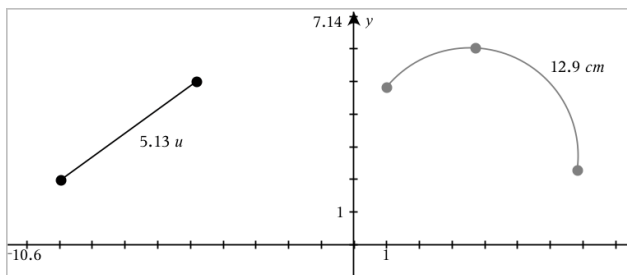

### Measuring Distance Between Two Points, a Point and a Line, or a Point and a Circle

1. From the **Measurement** menu, select **Length**. (In the Graphs application, click **Geometry > Measurement > Length**.)
2. Click the first point.
3. Click the second point or a point on the line or circle.

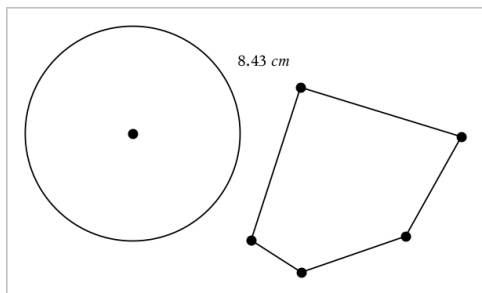

In this example, length is measured from the centre of the circle to the upper left vertex of the polygon.

### Measuring Circumference of a Circle or Ellipse or the Perimeter of a Polygon, Rectangle or Triangle

1. From the **Measurement** menu, select **Length**. (In the Graphs application, click **Geometry > Measurement > Length**.)
2. Click the object to display its circumference or perimeter.

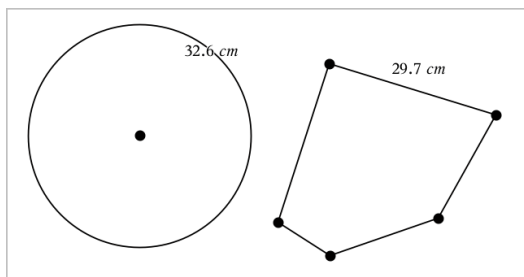

### Measuring a Side of a Triangle, Rectangle or Polygon

1. From the **Measurement** menu, select **Length**. (In the Graphs application, click **Geometry > Measurement > Length**.)
2. Click two points on the object that form the side you want to measure.

**Note:** You must click *two points* to measure a side. Clicking the side measures the entire length of the object's perimeter.

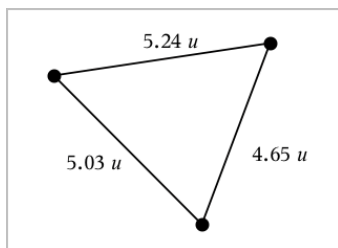

### Measuring Area of a Circle, Ellipse, Polygon, Rectangle or Triangle

**Note:** You cannot measure the area of a polygon constructed using the Segment tool.

1. From the **Measurement** menu, select **Area**. (In the Graphs application, click **Geometry > Measurement > Area**.)
2. Click the object to display its area.

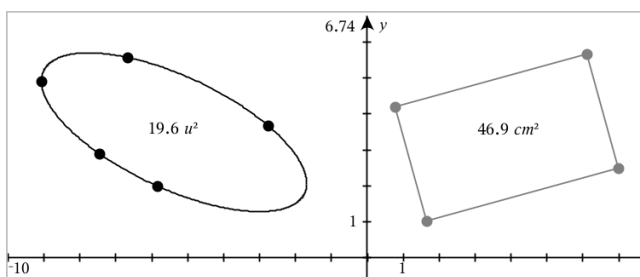

### Measuring Slope of a Line, Ray, Segment or Vector

1. From the **Measurement** menu, select **Slope**. (In the Graphs application, click **Geometry > Measurement > Slope**.)
2. Click the object to display its slope.

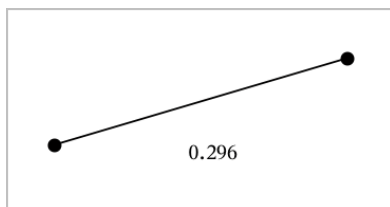

The value is updated automatically when you manipulate the object.

## Measuring Angles

Measured angles in the Geometry application range from  $0^\circ$  to  $180^\circ$ . Measured angles in the Graphs application range from 0 radians to  $\pi$  radians. To change the angle unit, use the **Settings** menu.

1. From the **Measurement** menu, select **Angle**. (In the Graphs application, click **Geometry > Measurement > Angle**.)
2. Click three locations or points to define the angle. The second click defines the vertex.

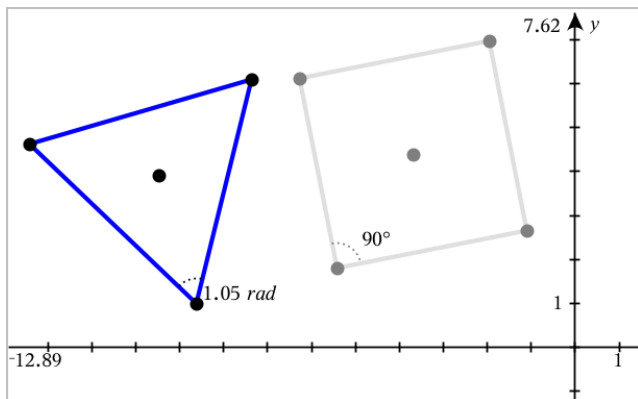

## Measuring Angles using the Directed Angle Tool

1. From the **Measurement** menu, select **Directed Angle**. (In the Graphs application, click **Geometry > Measurement > Directed Angle**.)
2. Click three locations or existing points to define the angle. The second click defines the vertex.

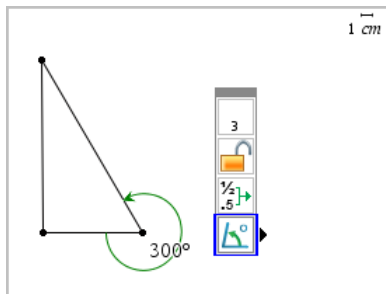

3. To reverse the measurement orientation,

- On the **Actions** menu, select **Attributes**.
- Click the angle text. For example, click  $300^\circ$ .
- Select the orientation attribute, and use the right or left arrow key to change it.
- Press **Esc** to close the Attributes tool.

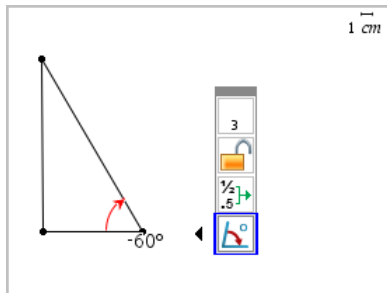

### Moving a Measured Value

- ▶ Drag the measurement to the desired location.

**Note:** If you move a measurement too far from its object, it stops following the object. However, its value continues to be updated as you manipulate the object.

### Editing a Measured Length

You can set the length of a side of a Triangle, Rectangle or Polygon by editing its measured value.

- ▶ Double-click the measurement, and then enter the new value.

### Storing a Measured Value as a Variable

Use this method to create a variable and assign a measured value to it.

- Display the item's context menu, and select **Store**.
- Type a variable name for the stored measurement.

### Linking a Measured Length to an Existing Variable

Use this method to assign a measured length value to an existing variable.

- Display the measurement's context menu, and select **Variables > Link to**.

The menu shows the list of currently defined variables.

- Click the name of the variable you want to link to.

## Deleting a Measurement

- Display the measurement's context menu, and select **Delete**.

## Locking or Unlocking a Measurement

1. Display the measurement's context menu, and select **Attributes**.
2. Use the up/down arrow keys to highlight the Lock attribute.
3. Use the left/right arrow keys to close or open the lock.

As long as the value remains locked, manipulations are not allowed that would require the measurement to change.

## Transforming Objects

You can apply transformations to drawn objects in both the Graphs and Geometry applications. If the object's points are labelled, the corresponding points in the transformed object are labelled using prime notation ( $A \rightarrow A'$ ). To enable automatic labelling of certain objects, see *What You Must Know* in this chapter.

### Exploring Symmetry

1. From the **Transformation** menu, select **Symmetry**. (In the Graphs application, click **Geometry > Transformation > Symmetry**.)
2. Click the object whose symmetry you want to explore.
3. Click a location or existing point to establish the point of symmetry.

A symmetrical image of the object is displayed.

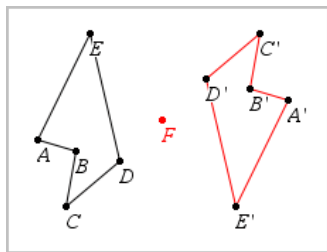

4. Manipulate the original object or the point of symmetry to explore the symmetry.

### Exploring Reflection

1. Create a line or segment to predefine the line about which the object will be reflected.

2. From the **Transformation** menu, select **Reflection**. (In the Graphs application, click **Geometry > Transformation > Reflection**.)
3. Click the object whose reflection you want to explore.
4. Click the predefined reflection line or segment.

A reflected image of the object is displayed.

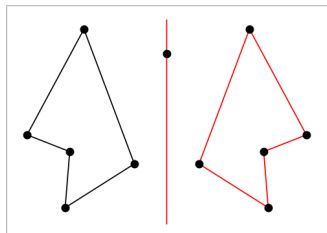

5. Manipulate the original object or the line of symmetry to explore the reflection.

### Exploring Translation

1. (Optional) Create a vector to predefine the distance and direction of translation.
2. From the **Transformation** menu, select **Translation**. (In the Graphs application, click **Geometry > Transformation > Translation**.)
3. Click the object whose translation you want to explore.
4. Click the predefined vector.

—or—

Click two locations on the work area to indicate the direction and distance of translation.

A translated image of the object is displayed.

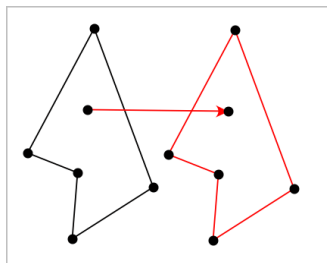

5. Manipulate the original object or the vector to explore the translation.

## Exploring Rotation

1. (Optional) Create an angle measurement to serve as a predefined angle of rotation.
2. From the **Transformation** menu, select **Rotation**. (In the Graphs application, click **Geometry > Transformation > Rotation**.)
3. Click the object whose rotation you want to explore.
4. Click a location or point to define the point of rotation.
5. Click the points of the predefined angle.  
—or—  
Click three locations to define an angle of rotation.

A rotated image of the object is displayed.

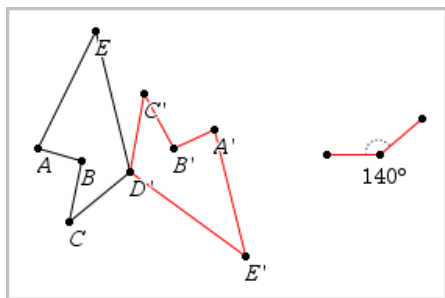

6. Manipulate the original object or the point of rotation to explore the rotation.

## Exploring Dilation

1. Create a Text object containing a numeric value to serve as a predefined dilation factor.

**Note:** You can also use a measured length value as the dilation factor. Keep in mind that if you use a large value, you may have to pan the display to view the dilated object.

2. From the **Transformation** menu, select **Dilation**. (In the Graphs application, click **Geometry > Transformation > Dilation**.)
3. Click the object whose dilation you want to explore.
4. Click a location or existing point to define the centre point of dilation.
5. Click the Text object or measurement that defines the dilation factor.

A dilated image of the object is displayed.



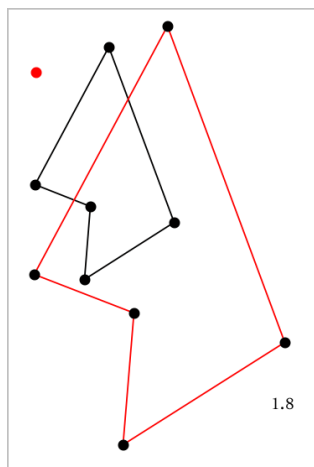

6. Manipulate the original object or the centre point of dilation to explore the dilation. You can also edit the dilation factor.

### ***Exploring with Geometric Construction Tools***

You can investigate scenarios by adding objects from the Construction tools. The constructions are dynamic. The midpoint of a line segment, for example, is updated automatically when you manipulate the endpoints.

While a construction is in progress, a tool appears in the work area (for example, **Parallel** ). To cancel, press **ESC**.

#### **Creating a Midpoint**

This tool lets you bisect a segment or define a midpoint between any two points. The points can be on a single object, on separate objects, or on the work area.

1. From the **Construction** menu, select **Midpoint**. (In the Graphs application, click **Geometry > Construction > Midpoint**.)
2. Click a point or location to define the first point.
3. Click a second point or location to complete the midpoint.

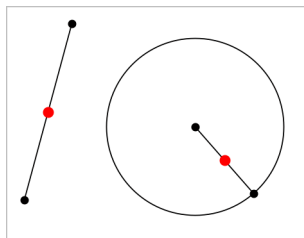

### Creating a Parallel Line

This tool creates a parallel line with respect to any existing line. The existing line can be a Graphs axis or any side of a triangle, square, rectangle, or polygon.

1. From the **Construction** menu, select **Parallel**. (In the Graphs application, click **Geometry > Construction > Parallel**.)
2. Click the object that will serve as the reference line.
3. Click a location to create the parallel line.

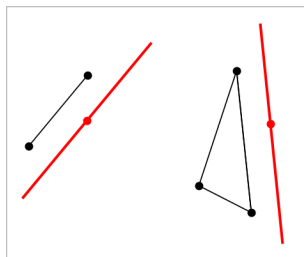

You can drag the parallel line to move it. If you manipulate the reference object, the line remains parallel.

### Creating a Perpendicular Line

You can create a line that is perpendicular to a reference line. The reference can be an axis, an existing line, a segment, or one side of a triangle, rectangle, or polygon.

1. From the **Construction** menu, select **Perpendicular**. (In the Graphs application, click **Geometry > Construction > Perpendicular**.)
2. Click a location or existing point through which the perpendicular line should pass.
3. Click the item that will serve as the reference line.

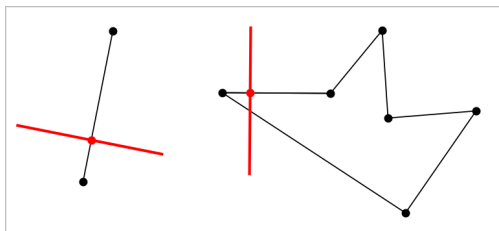

You can drag the intersection point to move the perpendicular. If you manipulate the reference object, the line remains perpendicular.

### Creating a Perpendicular Bisector

You can create a perpendicular bisector on a segment, on one side of a triangle, rectangle, or polygon, or between any two points.

1. From the **Construction** menu, select **Perpendicular Bisector**. (In the Graphs application, click **Geometry > Construction > Perpendicular Bisector**.)
2. Click the item that will serve as the reference line.  
—or—  
Click two points to create a perpendicular bisector between them.

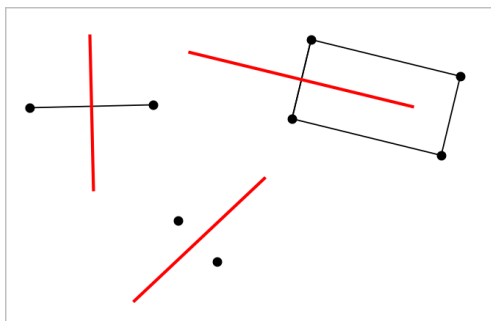

### Bisecting an Angle

This tool creates an angle bisector. The points of the angle can be on existing objects, or they can be locations on the work area.

1. From the **Construction** menu, select **Angle Bisector**. (In the Graphs application, click **Geometry > Construction > Angle Bisector**.)
2. Click three locations or points to define the angle. The second click defines the vertex of the angle.

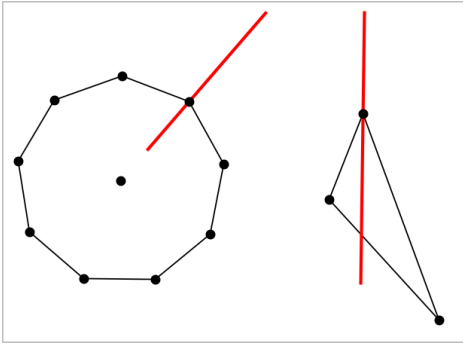

The angle bisector adjusts automatically as you manipulate its defining points.

### Creating a Locus

The Locus tool enables you to explore the range of motion of one object with respect to another object as constrained by a shared point.

1. Create a segment, line, or circle.
2. Create a point on the segment, line, or circle.

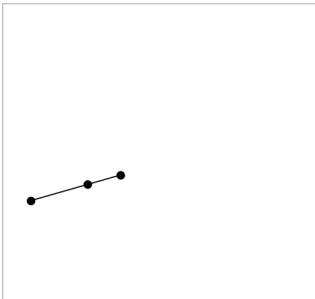

3. Create another object that uses the point created in the previous step.

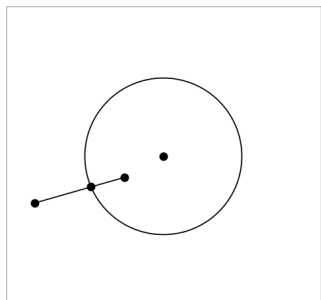

Circle created to use the defined point on the segment.

4. From the **Construction** menu, select **Locus**. (In the Graphs application, click **Geometry > Construction > Locus**.)
5. Click the point shared by the objects.
6. Click the object defined to share the point (this is the object to vary).

The continuous locus is displayed.

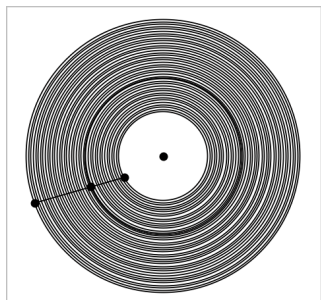

### Creating a Compass

This tool operates similarly to a geometric compass used for drawing circles on paper.

1. From the **Construction** menu, select **Compass**. (In the Graphs application, click **Geometry > Construction > Compass**.)
2. To set the width (radius) of the compass:

Click a segment.

—or—

Click any side of a triangle, rectangle, polygon, or regular polygon.

—or—

Click any two existing points or locations on the work area.

3. Click a location to establish the centre of the circle and complete the construction.

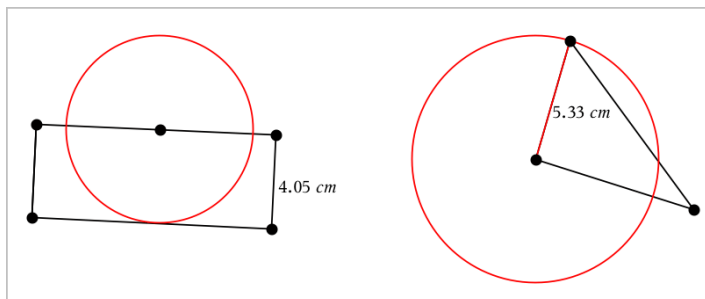

The radius adjusts automatically as you manipulate the original segment, side, or points used to define the radius.

## ***Animating Points on Objects***

You can animate any point created as a point on an object or graph. Multiple points can be animated simultaneously.

### **Animating a Point**

1. From the **Actions** menu, select **Attributes**.
2. Click the point to display its attributes.
3. Press ▼ to select the animation attributes.
4. Press ◀ or ▶ to choose either unidirectional or alternating animation.
5. Type a value to set the animation speed. Any nonzero speed begins the animation. To reverse the direction, enter a negative value.
6. Press **Enter** to display the animation controls ◀ ◻ ▶ ◻.
7. Press **ESC** to close the Attributes tool.

### **Pausing and Resuming All Animations**

- ▶ To pause all animations on a page, click **Pause** ◻ ◻.
- ▶ To resume all animations, click **Play** ◻ ▶.

## Resetting All Animations

Resetting pauses all animations and returns all animated points to the positions they occupied when they were first animated.

- To reset animation, click **Reset** .

## Changing or Stopping the Animation of a Point

1. Click **Reset**  to stop all animation.
2. From the **Actions** menu, select **Attributes**.
3. Click the point to display its attributes.
4. Select the animation attribute, and type a new animation speed. To stop the point's animation, enter zero.

**Note:** If other animated points exist, the animation controls remain in the work area.

## Adjusting Variable Values with a Slider

A slider control lets you interactively adjust or animate the value of a numeric variable. You can insert sliders in the Graphs, Geometry, Notes and Data & Statistics applications.

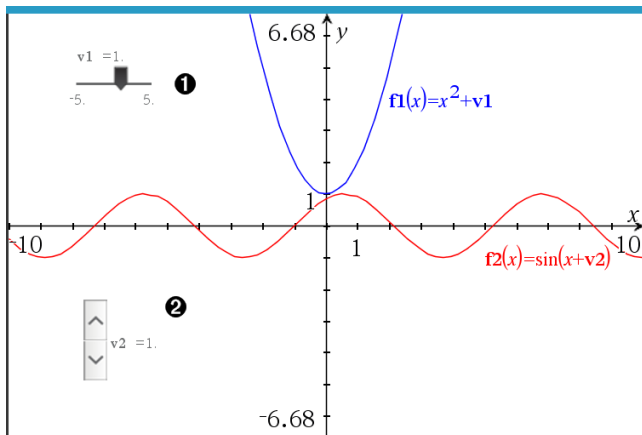

- 1 Horizontal slider for adjusting variable  $v_1$ .
- 2 Minimised vertical slider for adjusting variable  $v_2$ .

**Note:** TI-Nspire™ version 4.2 or higher is required for opening .tns files containing sliders on Notes pages.

## Inserting a Slider Manually

1. From a Graphs, Geometry or Data & Statistics page, select **Actions > Insert Slider**.  
—or—  
From a Notes page, make sure the cursor is not in a maths box or chem box, and then select **Insert > Insert Slider**.

The Slider Settings screen opens.

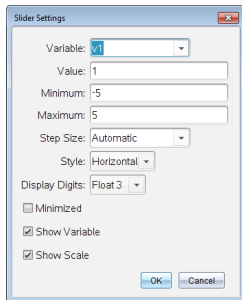

2. Enter the desired values, and click **OK**.

The slider is displayed. On a Graphs, Geometry or Data & Statistics page, handles are displayed to let you move or stretch the slider.

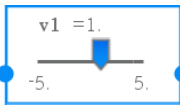

To remove the handles and use the slider, click an empty space in the work area. You can show the handles any time by selecting **Move** from the slider's context menu.

3. To adjust the variable, slide the pointer (or click the arrows on a minimised slider).
  - You can use the **Tab** key to move the focus to a slider or to move from one slider to the next. The colour of the slider changes to show you when it has the focus.
  - When a slider has the focus, you can use the arrow keys to change the value of the variable.

## Working with the Slider

Use the options on the context menu to move or delete the slider, and to start or stop its animation. You can also change the slider's settings.

1. Display the slider's context menu.



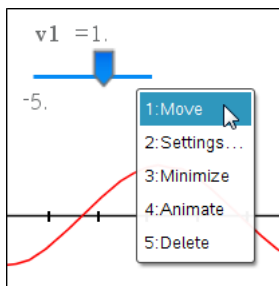

2. Click an option to select it.

### Automatic Sliders in Graphs

Sliders can be created for you automatically in the Graphs application and in the analytic window of the Geometry application. You are offered automatic sliders when you define certain functions, equations or sequences that refer to undefined variables.

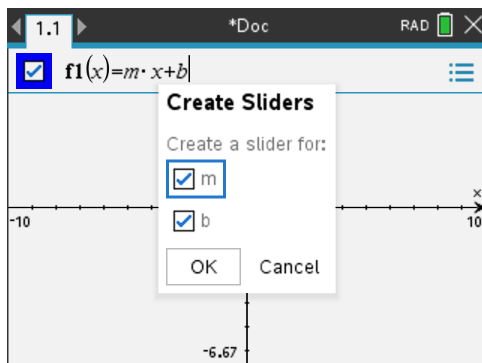

### Labelling (Identifying) the Coordinates of a Point

The Graphs application can identify and label the coordinates of any existing point, provided the point was created in the Graphs application.

1. From the **Actions** menu, select **Coordinates and Equations**.

The tool appears at the top of the work area

2. Tap the point whose coordinates you want to show.

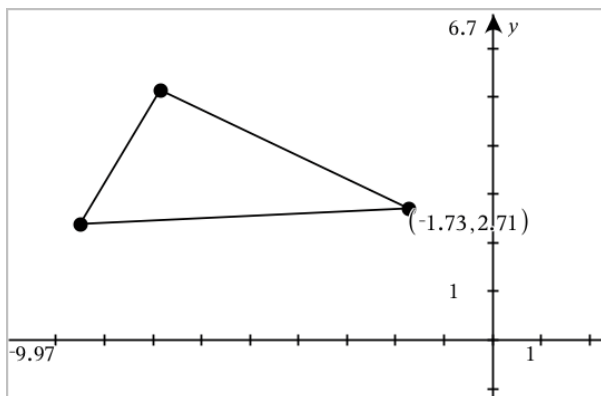

3. Press **Esc** to close the tool.

If you later move the point to a different location, the coordinates follow the point and update automatically.

### ***Displaying the Equation of a Geometric Object***

You can display the equation of a line, tangent line, circle shape, or geometric conic, provided the object was constructed in the Graphing View or within the Analytic Window of the Plane Geometry View.

**Note:** Due to differences in the numerical representations of analytic and geometric conics, the capability to convert a geometric conic to an analytic template may sometimes be unavailable. This is done in order to avoid a situation where the template-based conic would be different from the geometric one.

1. From the **Actions** menu, click **Coordinates and Equations**.
2. Move the pointer to the object.

The equation for the object appears.

**Note:** If you approach a defined point on the line or the centre point of a circle, the coordinates of that point are displayed instead of the equation. Move the pointer away from the defined point to obtain the equation of the object.

3. Click to attach the equation to the pointer.
4. Move the equation to the desired location, and click to anchor it.

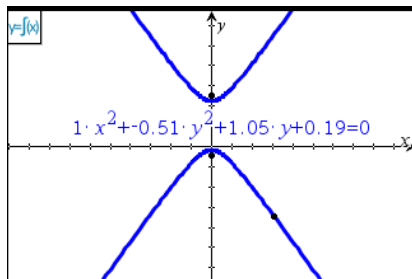

5. Press **Esc** to exit the tool.

### **Using the Calculate Tool**

The Calculate tool is available in the Graphs and Geometry applications. It lets you evaluate a maths expression you have entered as a text object.

The following example uses the Calculate tool to calculate the measured angles of a triangle.

1. Using the **Shapes** menu, create a triangle and then measure its angles.

**Tip:** You can enable options to automatically label points and to force geometric triangle angles to integers. For more information, see *What You Must Know*, in this chapter.

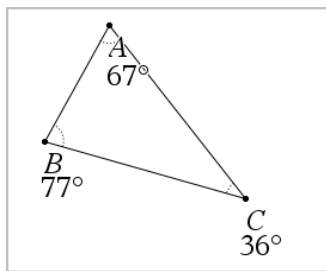

2. From the **Actions** menu, click **Text**.
3. Click a location for the text, and type the formula for the calculation.

In this example, the formula calculates three terms.

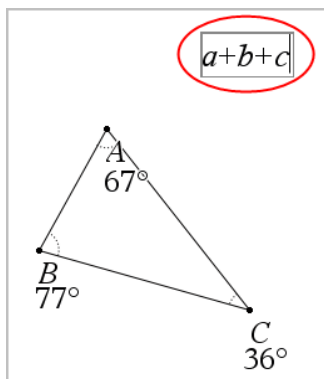

- From the **Actions** menu, click **Calculate**.
- Click the formula you created.

You are prompted to select a value for each term in the formula.

- Click each angle measurement when prompted.

**Note:** If you have stored a measurement as a variable, you can select it when prompted by clicking . If the name of a stored measurement matches a term in the formula, you can press "L" when prompted for that term.

After you have selected the third term, the calculation result attaches itself to the pointer.

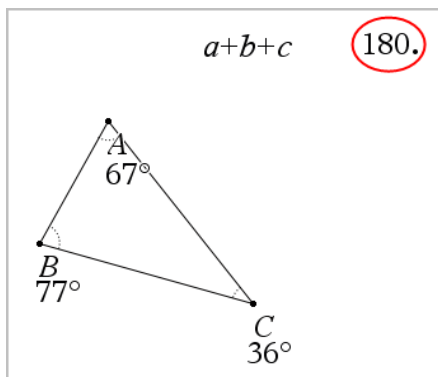

- Position the result, and press **Enter** to anchor it as a new text object.

## 3D Graphs

The 3D Graphing view lets you create and explore three-dimensional graphs of:

- 3D functions of the form  $z(x,y)$
- 3D parametric plots

### Selecting the 3D Graphing View

The 3D Graphing View is available on any Graphs page  or Geometry page .

► From the **View** menu, select **3D Graphing**.

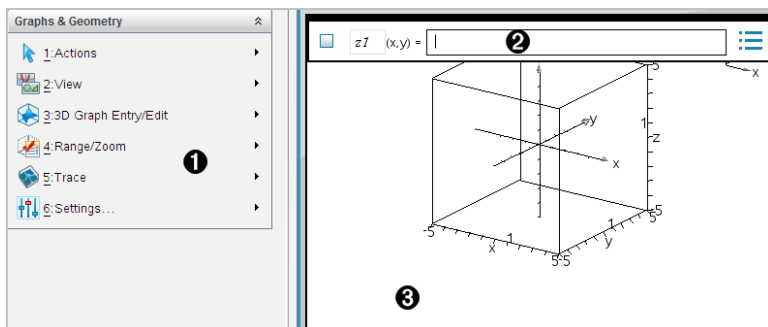

- 1 3D Graphs Menu**
- 2 Entry line.** Lets you define 3D graphs. The default graph type is 3D Function, indicated by  $z1(x,y)=$ .
- 3 3D Graphs Work Area.** Shows a 3D box containing graphs that you define. Drag to rotate the box.

### Graphing 3D Functions

1. In the 3D Graphing view, select **3D Graph Entry/Edit > Function**.

The entry line appears.

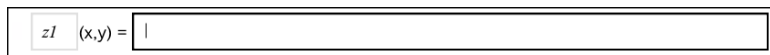

2. Enter the expression that defines the graph. You can type the expression or build it using expression templates.

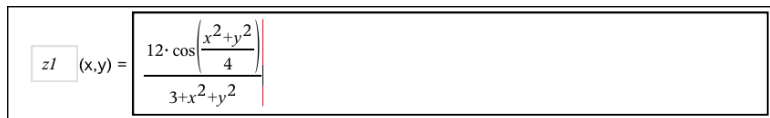

- Press **Enter** to create the graph and hide the entry line. You can show or hide the entry line anytime by pressing **Ctrl+G**.

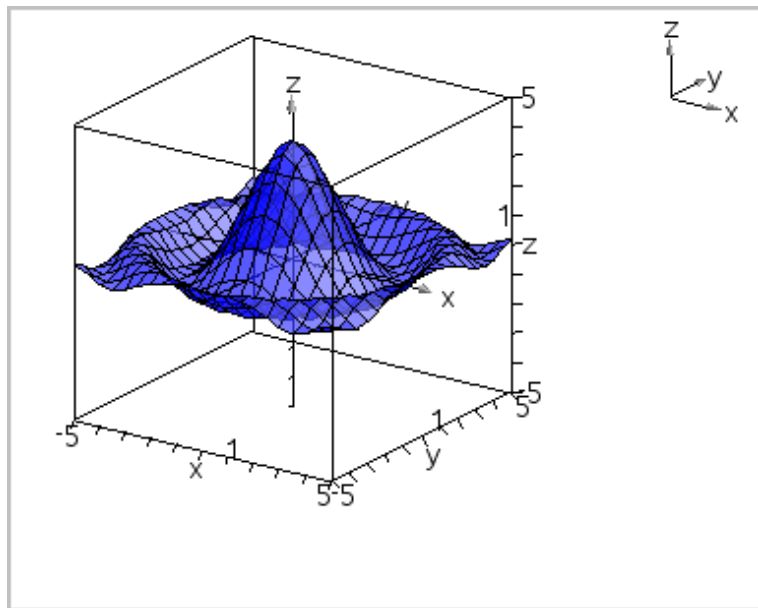

### Graphing 3D Parametric Equations

- In the 3D Graphing view, select **3D Graph Entry/Edit > Parametric**.

The entry line appears.

$xp1$	(t,u) =	<input type="text"/>	
$yp1$	(t,u) =	<Enter expression>	...
$zp1$	(t,u) =	<Enter expression>	

- Type the equations that define the graph.

$xp1$	(t,u) =	$4 \cdot \cos(t) - \sin(u) \cdot \cos(t)$	
$yp1$	(t,u) =	$4 \cdot \sin(t) - \sin(u) \cdot \sin(t)$	...
$zp1$	(t,u) =	$\cos(u)$	

- Press **Enter** to draw the graph and hide the entry line and keyboard. You can show or hide the entry line anytime by pressing **Ctrl+G**.

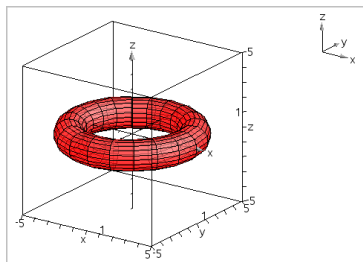

- To set the graphing parameters  $tmin$ ,  $tmax$ ,  $umin$ , and  $umax$ , display the graph's context menu, and select **Edit Parameters**.

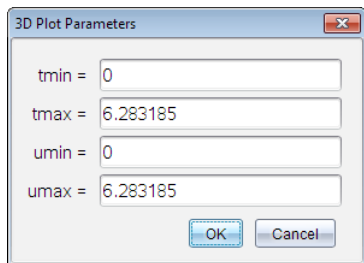

## Rotating the 3D View

### Rotating Manually

- Press **R** to activate the Rotation tool.
- Press any of the four arrow keys to rotate the graph.

### Rotating Automatically

Auto rotation is equivalent to holding down the right arrow key.

- Press **A**.

The Auto Rotation icon  appears, and the graph rotates.

- (Optional) Use the up and down arrow keys to explore the rotating graph.
- To stop the rotation and return to the Pointer tool, press **Esc**.

### Viewing from Specific Orientations

- If necessary, press **Esc** to return to the Pointer tool.
- Use letter keys to select the orientation:
  - Press **Z**, **Y**, or **X** to view along the z, y, or x axis.
  - Press letter **O** to view from the default orientation.

## Editing a 3D Graph

1. Double-click the graph to show its expression in the entry line.  
—or—  
Display the graph's context menu, and then click **Edit Relation**.

2. Modify the existing expression, or type a new expression in the entry line.
3. Press **Enter**.

## Accessing the Graph History

For each problem, the software stores a history of relations defined in the Graphs application and 3D Graphing view, such as function graphs **f1** through **f99** and 3D function graphs **z1** through **z99**. You can view and edit these items using a button on the entry line.

### Viewing the History

1. Press **Ctrl+G** to show the entry line.
2. Click the **History Menu** button  on the entry line.

The menu is displayed. As you point to the name of each item, its expression appears in the entry line.

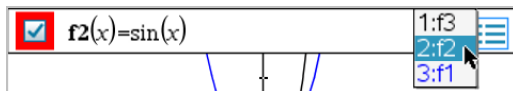

3. Select the name of the relation you want to view or edit.
4. (Optional) From the entry line, use the up and down arrow keys to scroll through the defined relations of the same type.

### Viewing the History of Specific Relation Types

Use this method if you want to view or edit a defined relation that does not appear in the History menu.

1. On the **Graph Entry/Edit** menu, click the relation type. For example, click **Polar** to show the entry line for the next available Polar relation.
2. Click the **History Menu** button , or use the up and down arrow keys to scroll through the defined relations of the same type.



## Changing the Appearance of a 3D Graph

### Setting Wire and Surface Colour:

1. Display the graph's context menu, click **Colour**, and then click **Line Colour** or **Fill Colour**.
2. Click a colour swatch to apply it.

### Setting Custom Plot Colours:

You can assign different colours to a graph's top and bottom surfaces or choose to have the graph coloured automatically, based on height or steepness. You can also set the wire colour.

1. Display the graph's context menu, and then click **Colour > Custom Plot Colour**.

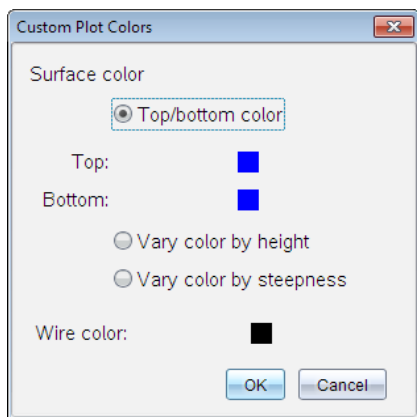

2. Select one of the three Surface colour options: **Top/bottom colour**, **Vary colour by height**, or **Vary colour by steepness**.
  - If you choose Top/bottom colour, click the colour swatches to select colours for the top and bottom surfaces.
  - If you choose to vary colour by height or steepness, colours are determined automatically.
3. To set the Wire colour, click the colour swatch and select a colour.

### Setting Other Attributes of a Graph:

1. Display the graph's context menu, and then click **Attributes**. You can set the following attributes for the selected graph.
  - format: surface+wire, surface only, or wire only

- x resolution (enter a value in range 2-200\*, default=21)
- y resolution (enter a value in range 2-200\*, default=21)
- transparency (enter a value in range 0-100, default=30)

\* Handhelds are limited to a maximum display resolution of 21, regardless of the value entered.

2. Set the attributes as you like, and then press **Enter** to accept the changes.

### **Showing or Hiding a Graph's Label**

- ▶ Display the graph's context menu, and then click **Hide Label** or **Show Label**.

### ***Showing and Hiding 3D Graphs***

1. In the 3D Graphing view, select **Actions > Hide/Show**.

The Hide/Show tool  appears, and all hidden items are displayed in grey.

2. Tap a graph to change its hide/show state.
3. To apply the changes and dismiss the tool, press **Esc**.

**Note:** If you want to show or hide only the graph's label, see [Showing or Hiding a Graph's Label](#).

### ***Customising the 3D Viewing Environment***

#### **Setting the Background Colour**

- ▶ Display the context menu for the work area, and then click **Background Colour**.

#### **Showing or Hiding Specific View Elements**

- ▶ From the **View** menu, click the item to show or hide. You can choose items such as the 3D box, axes, box end values and legend.

#### **Changing the 3D Projection**

- ▶ From the **View** menu, click **Orthographic Projection** or **Perspective View**.

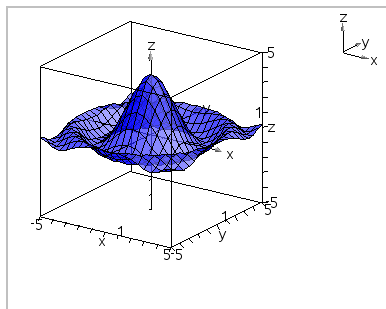

*Orthographic Projection (default)*

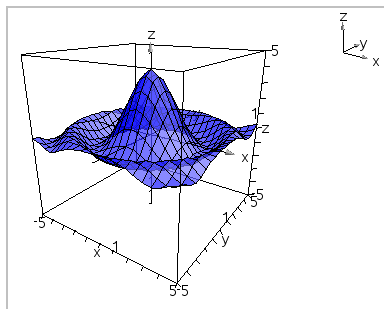

*Perspective View*

### Setting the Visual Attributes of the Box and Axes

1. Display the context menu for the box, and then click **Attributes**. You can set the following attributes.
  - Show or hide tic labels
  - Show or hide end values
  - Show or hide arrows on axes
  - Show 3D or 2D arrow heads
2. Set the attributes as you like, and then press **Enter** to accept the changes.

### Shrinking or Magnifying the 3D View

- From the **Range/Zoom** menu, click **Shrink Box** or **Magnify Box**.

### Changing the 3D Aspect Ratio

1. From the **Range/Zoom** menu, click **Aspect Ratio**.
2. Enter values for the x, y and z axes. The default value for each axis is **1**.

### Changing the Range Settings

- On the **Range/Zoom** menu, click **Range Settings**. You can set the following parameters.
  - XMin (default=-5)  
XMax (default=5)  
XScale (default=**Auto**) You can enter a numeric value.
  - YMin (default=-5)  
YMax (default=5)  
YScale (default=**Auto**) You can enter a numeric value.

- ZMin (default=-5)  
ZMax (default=5)  
ZScale (default=Auto) You can enter a numeric value.
- eye  $\theta^\circ$  (default=35)  
eye  $\phi^\circ$  (default=160)  
eye distance (default=11)

### Tracing in the 3D View

1. From the **Trace** menu, select **z Trace**.

The z Trace icon  and the trace plane appear, along with a text line showing the current "z=" trace value.

2. To move the trace, hold down **Shift** and press the up or down arrow key.

The "z=" text is updated as you move.

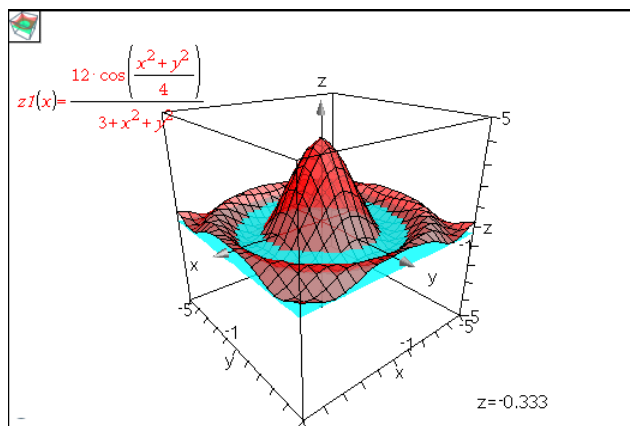

3. (Optional) Use the four arrow keys to rotate the view and see how the trace plane and the graph intersect.
4. To stop tracing and return to the Pointer tool, press **Esc**.

### Changing the Trace Settings

1. From the **Trace** menu, select **Trace Setup**.

The 3D Trace Setup dialogue box opens.

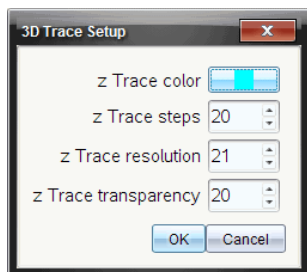

2. Enter or select the settings, and click **OK** to apply them.
3. If you are not already tracing, your new settings take effect the next time you trace.

### **Example: Creating an Animated 3D Graph**

1. Insert a new problem and select the 3D Graphing view.
2. From the **Actions** menu, select **Insert Slider**, click to position it, and type **time** as the variable name.
3. Display the slider's context menu, click **Settings**, and enter the following values.

Value: **3.8**  
 Minimum: **3.2**  
 Maximum: **4.4**  
 Step Size: **0.1**

4. In the entry line, define the function shown here:

$$z1(x,y) = 3 + \frac{|\sin(\text{time})|}{x^2 + y^2}$$

5. Drag the slider thumb to see the effect of varying *time*.

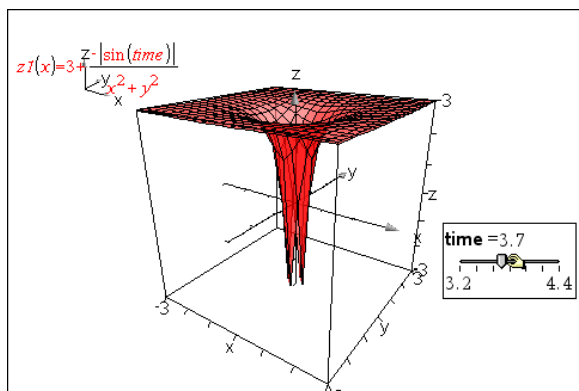

6. Add visual interest. For example:

- [Change the background colour](#) of the work area.
- [Hide the box, axes, or legend.](#)
- [Automatically rotate](#) the graph.
- [Change the graph's fill colour and hide its lines.](#)
- Change the graph's [transparency and shading.](#)

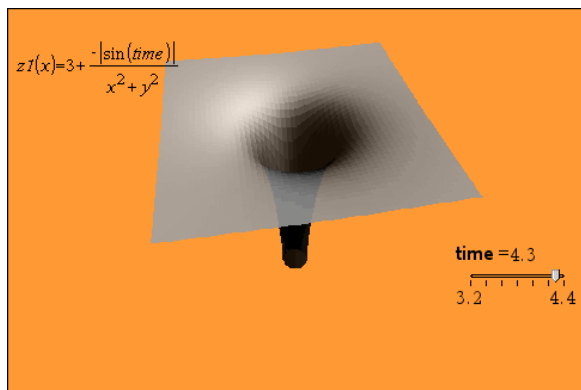

- To animate the graph, display the slider's context menu, and click **Animate**. (To stop, click **Stop Animate** from the context menu.)

You can combine manual or auto rotation with the slider animation. Experiment with the x and y resolution to balance curve definition against animation smoothness.

# Geometry Application

The Geometry application lets you:

- Create and explore geometric objects and constructions.
- Manipulate and measure geometric objects.
- Animate points on objects and explore their behaviour.
- Explore object transformations.

## Adding a Geometry Page

- ▶ To start a new document with a blank Geometry page:

From the main **File** menu, click **New Document**, and then click **Add Geometry**.

Handheld: Press **[on]**, and select **Geometry** .

- ▶ To add a Geometry page in the current problem of an existing document:

From the toolbar, click **Insert > Geometry**.

Handheld: Press **[doc]** and select **Insert > Geometry**.

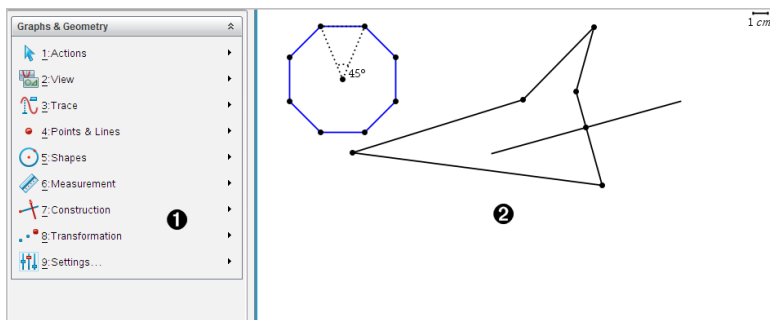

- 1 Geometry menu – Available anytime you are viewing a Geometry page.
- 2 Geometry work area -- The area where you create and explore geometric objects.

## What You Must Know

### Changing the Graphs and Geometry Settings

1. From the **Settings** menu in the Documents Toolbox, select **Settings**.
2. Select the settings that you want to use.
  - **Display Digits**. Sets the display format for numbers as Floating or Fixed decimal.

- **Graphing Angle.** Sets the angle unit for all Graphs and 3D Graphing applications in the current document. The default setting is Radian. Set this to Auto if you want graphing angles to follow the Angle setting in the main **File > Settings** menu. An angle mode indicator shows the resulting mode in Graphs and 3D Graphing applications.
- **Geometry Angle.** Sets the angle unit for all Geometry applications in the current document. The default setting is Degree. Set this to Auto if you want geometry angles to follow the Angle setting in the main **File > Settings** menu. An angle mode indicator shows the resulting mode in Geometry applications.
- **Grid.** Sets the grid display in the Graphs application. The default setting is No Grid. Dot Grid and Lined Grid are also available.
- **Automatically hide plot labels.** In the Graphs application, hides the label that normally appears next to a graphed relation.
- **Show axis end values.** Applies only in the Graphs application.
- **Show tool tips for function manipulation.** Applies only in the Graphs application.
- **Automatically find points of interest.** In the Graphs application, shows zeros, minima and maxima while tracing function graphs.
- **Force Geometric Triangle Angles to Integers.** Restricts the angles of a triangle to integer values as you create or edit the triangle. This setting applies only in the Geometry View with the Geometry Angle unit set to Degree or Gradian. It does not apply to analytic triangles in Graphing View or to analytic triangles in the Analytic Window of the Geometry View. This setting does not affect existing angles, and it does not apply when constructing a triangle based on previously inserted points. By default, this setting is deselected.
- **Automatically Label Points.** Applies labels ( $A, B, \dots, Z, A_1, B_1,$  and so on) to points, lines, and vertices of geometric shapes as you draw them. The labelling sequence starts at  $A$  for each page in a document. By default, this setting is deselected.



**Note:** If you create a new object that uses existing un-labelled points, those point are not automatically labelled in the completed object.

- Click **Restore** to restore all settings to their factory defaults.
- Click **Make Default** to apply the current settings to the open document and save them as the default for new Graphs and Geometry documents.



## Using Context Menus

Context menus provide quick access to commonly used commands and tools that apply to a specific object. For example, you can use a context menu to change an object's line colour or to group a set of selected objects.

- ▶ Display the context menu for an object in one of the following ways.
  - Windows®: Right-click the object.
  - Mac®: Hold  and click the object.
  - Handheld: Move the pointer to the object, and then press  .

## Finding Hidden Objects in the Graphs or Geometry Application

You can hide and show individual graphs, geometric objects, text, labels, measurements and axis end-values.

To temporarily view hidden graphs or objects or to restore them as shown objects:

1. From the **Actions** menu, select **Hide/Show**.

The Hide/Show tool  appears in the work area, and all hidden objects become visible in dimmed colours.

2. Click a graph or object to toggle its Hide/Show state.
3. To apply the changes and close the Hide/Show tool, press **ESC**.

## Inserting a Background Image

You can insert an image as a background for a Graphs or Geometry page. The file format of the image can be .bmp, .jpg or .png.

1. From the **Insert** menu, click **Image**.
2. Navigate to the image you want to insert, select it and then click **Open**.

For information on moving, resizing, and deleting a background image, see [Working with Images in the Software](#).

## Adding Text to the Graphs or Geometry Work Area

1. From the **Actions** menu, select **Text**.

The Text tool  appears in the work area.

2. Click the location for the text.

3. Type the text in the box that appears, and then press **Enter**.

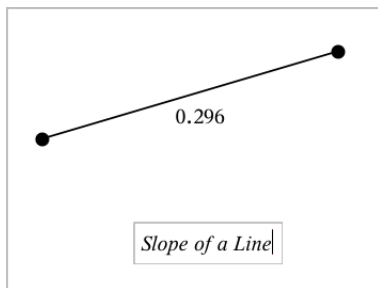

4. To close the Text tool, press **ESC**.
5. To edit the text, double-click it.

### **Deleting a Relation and its Graph**

1. Select the relation by clicking its graph.
2. Press **Backspace** or **DEL**.

The graph is removed from both the work area and the graph history.

## ***Introduction to Geometric Objects***

Geometry tools are accessible in both the Graphs and Geometry applications. You can use these tools to draw and investigate objects such as points, lines, and shapes.

- The Graphing view shows the Graphs work area superimposed on the Geometry work area. You can select, measure, and alter objects in both work areas.
- The Plane Geometry view shows only the objects created in the Geometry application.

### **Objects Created in the Graphs Application**

Points, lines, and shapes created in the Graphs application are analytic objects.

- All points that define these objects reside on the  $x,y$  graph plane. Objects created here are visible only in the Graphs application. Changing the axes scale affects the appearance of the objects.
- You can display and edit the coordinates of any point on an object.
- You can display the equation of a line, tangent line, circle shape, or geometric conic created in the Graphs application.

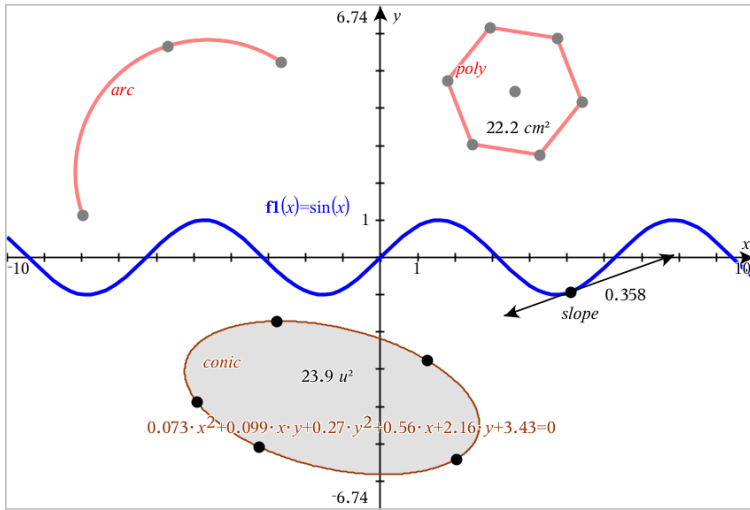

The circle arc and polygon were created in the Geometry application. The sine wave and conic were created in the Graphs application.

### Objects Created in the Geometry Application

Points, lines, and shapes created in the Geometry application are not analytic objects.

- Points that define these objects do not reside on the graph plane. Objects created here are visible in both the Graphs and Geometry applications, but they are unaffected by changes to the Graphs x,y axes.
- You cannot obtain the coordinates of an object's points.
- You cannot display the equation of a geometric object created in the Geometry application

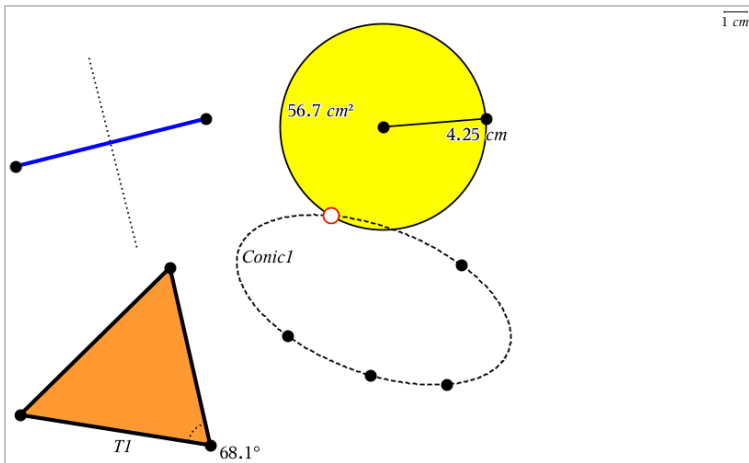

## Creating Points and Lines

As you create an object, a tool appears in the work area (for example, **Segment** ). To cancel, press **ESC**. To enable automatic labeling of certain objects, see *What You Must Know* in this chapter.

### Creating a Point on the Work Area

1. From the **Points and Lines** menu, select **Point**. (In the Graphs application, click **Geometry > Points and Lines > Point**.)
2. Click a location to create the point.
3. (Optional) Label the point.
4. To move a point, drag it.

### Creating a Point on a Graph or Object

You can create a point on a line, segment, ray, axis, vector, circle, graph or axis.

1. From the **Points and Lines** menu, select **Point On**. (In the Graphs application, click **Geometry > Points and Lines > Point On**.)
2. Click the graph or object on which you want to create the point.
3. Click a location on the object to place the point.

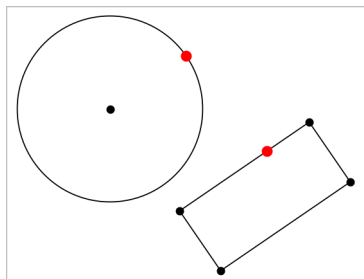

## Creating a Dynamic Point on a Graph

You can create a dynamic point on a graph with Point by Coordinates.

1. From the **Points and Lines** menu, select **Point by Coordinates**. (In the Graphs application, click **Geometry > Points and Lines > Point by Coordinates** or press **P** and select **Point by Coordinates**).

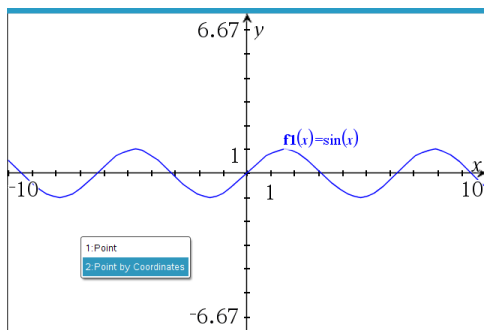

2. Enter the variables or expressions for one or both of the coordinates.

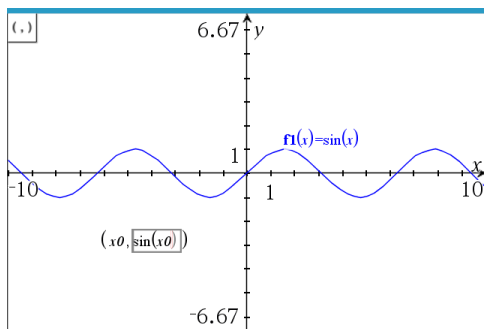

3. Use the slider that is created to move the point on the graph.

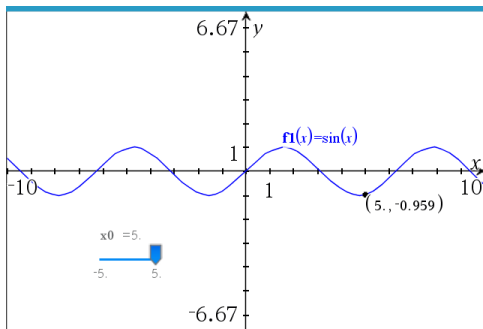

The point will display the actual coordinates. If you hover the cursor over a coordinate, it will display the variable or expression.

To edit the point, double-click the coordinate on the label. Any variable or expression that was entered before is retained.

### Identifying Points of Intersection

1. From the **Points and Lines** menu, select **Intersection Points**. (In the Graphs application, click **Geometry > Points and Lines > Intersection Points**.)
2. Click two intersecting objects to add points at their intersections.

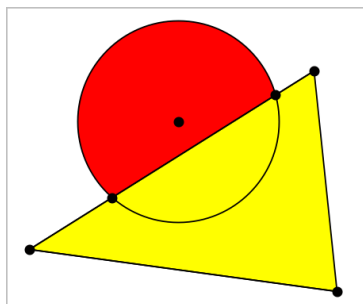

### Creating a Line

1. From the **Points and Lines** menu, select **Line**. (In the Graphs application, click **Geometry > Points and Lines > Line**.)
2. Click a location to define one point on the line.
3. Click a second location to define the direction of the line and the length of its visible portion.

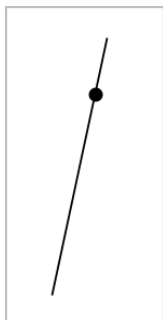

4. To move a line, drag its identifying point. To rotate it, drag any point except the identifying point or ends. To extend its visible portion, drag from either end.

### Creating a Segment

1. From the **Points and Lines** menu, select **Segment**. (In the Graphs application, click **Geometry > Points and Lines > Segment**.)
2. Click two locations to define the endpoints of the segment.

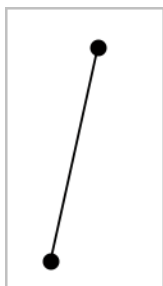

3. To move a segment, drag any point other than an endpoint. To manipulate the direction or length, drag either endpoint.

### Creating a Ray

1. From the **Points and Lines** menu, select **Ray**. (In the Graphs application, click **Geometry > Points and Lines > Ray**.)
2. Click a location to define the endpoint of the ray.
3. Click a second location to define the direction.

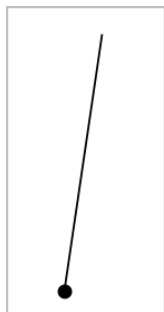

To move a ray, drag its identifying point. To rotate it, drag any point except the identifying point or end. To extend its visible portion, drag from the end.

### Creating a Tangent

You can create a tangent line at a specific point on a geometric object or function graph.

1. From the **Points and Lines** menu, select **Tangent**. (In the Graphs application, click **Geometry > Points and Lines > Tangent**.)
2. Click the object to select it.
3. Click a location on the object to create the tangent.

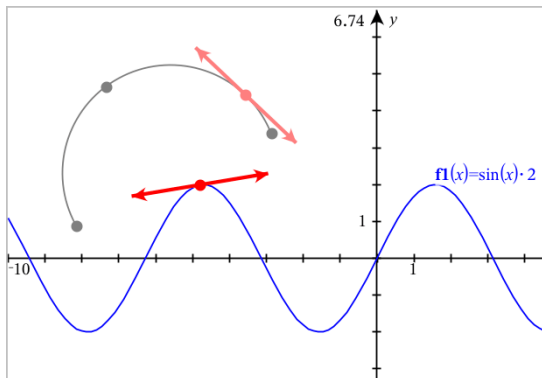

4. To move a tangent, drag it. It remains attached to the object or graph.

### Creating a Vector

1. From the **Points and Lines** menu, select **Vector**. (In the Graphs application, click **Geometry > Points and Lines > Vector**.)



2. Click a location to establish the vector's initial point.
3. Click a second location to specify direction and magnitude and complete the vector.

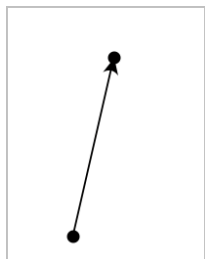

4. To move a vector, drag any point other than the endpoints. To manipulate the magnitude and/or direction, drag either end point.

**Note:** If you create an endpoint on an axis or another object, you can move the endpoint only along that object.

### Creating a Circle Arc

1. From the **Points and Lines** menu, select **Circle Arc**. (In the Graphs application, click **Geometry > Points and Lines > Circle Arc**.)
2. Click a location or point to establish the starting point of the arc.
3. Click a second point to establish an intermediate point through which the arc will pass.
4. Click a third point to set the ending point and complete the arc.

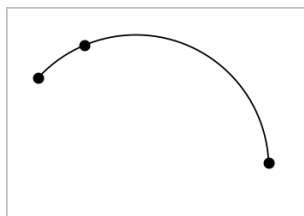

5. To move an arc, drag its perimeter. To manipulate it, drag any of its three defining points.

### Creating Geometric Shapes

The Shape tools let you explore circles, polygons, conics and other geometric objects.

As you create a shape, a tool appears in the work area (for example, **Circle** ). To cancel the shape, press **ESC**. To enable automatic labelling of certain objects, see *What You Must Know*, in this chapter.

### Creating a Circle

1. From the **Shapes** menu, select **Circle**. (In the Graphs application, click **Geometry > Shapes > Circle**.)
2. Click a location or point to position the circle's centre point.
3. Click a location or point to establish the radius and complete the circle.

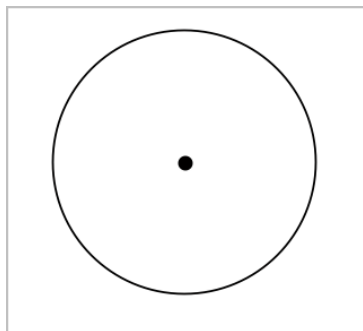

4. To resize a circle, drag its perimeter. To move it, drag its centre point.

### Creating a Triangle

**Note:** To ensure that the total of the angles of a triangle equals  $180^\circ$  or 200 gradians, you can force integer angles in the Geometry view. Refer to *What You Must Know*, in this chapter.

1. From the **Shapes** menu, select **Triangle**. (In the Graphs application, click **Geometry > Shapes > Triangle**.)
2. Click three locations to establish the vertices of the triangle.

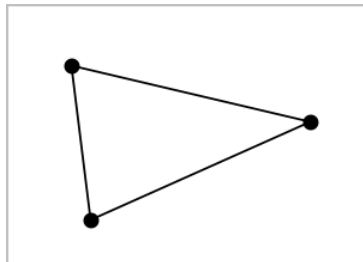

3. To manipulate a triangle, drag any point. To move it, drag any side.

### Creating a Rectangle

1. From the **Shapes** menu, select **Rectangle**. (In the Graphs application, click **Geometry > Shapes > Rectangle**.)
2. Click a location or point to establish the first corner of the rectangle.
3. Click a location for the second corner.

One side of the rectangle is displayed.

4. Click to establish the distance to the opposite side and complete the rectangle.

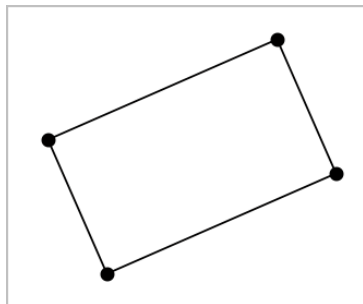

5. To rotate a rectangle, drag one of its first two points. To extend it, drag one of the last two points. To move it, drag any side.

### Creating a Polygon

1. From the **Shapes** menu, select **Polygon**. (In the Graphs application, click **Geometry > Shapes > Polygon**.)
2. Click a location or point to establish the first vertex of the polygon.
3. Click to establish each additional vertex.
4. To complete the polygon, click the first vertex.

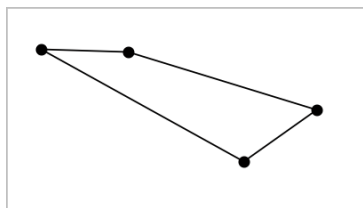

5. To manipulate a polygon, drag any vertex. To move it, drag any side.

## Creating a Regular Polygon

1. From the **Shapes** menu, select **Regular Polygon**. (In the Graphs application, click **Geometry > Shapes > Regular Polygon**.)
2. Click once on the work area to establish the centre point.
3. Click a second location to establish the first vertex and radius.

A 16-sided regular polygon is formed. The number of sides is displayed in brackets; for example, {16}.

4. Drag any vertex in a circular motion to set the number of sides.
  - Drag clockwise to reduce the number of sides.
  - Drag counter-clockwise to add diagonals.

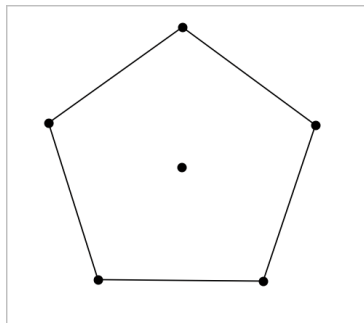

5. To resize or rotate a regular polygon, drag any of its points. To move it, drag any side.

## Creating an Ellipse

1. From the **Shapes** menu, select **Ellipse**. (In the Graphs application, click **Geometry > Shapes > Ellipse**.)
2. Click two locations or points to establish the foci.
3. Click to establish a point on the ellipse and complete the shape.

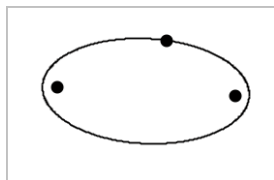

4. To manipulate an ellipse, drag any of its three defining points. To move it, drag its perimeter.

### Creating a Parabola (from focus and vertex)

1. From the **Shapes** menu, select **Parabola**. (In the Graphs application, click **Geometry > Shapes > Parabola**.)
2. Click a location to establish the focus.
3. Click a location to establish the vertex and complete the parabola.

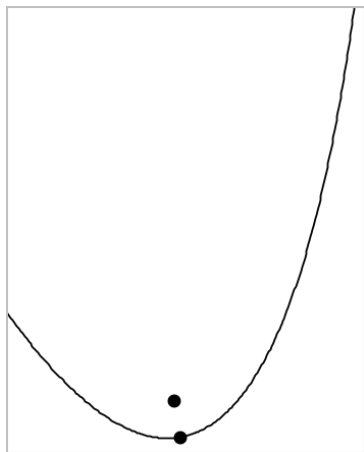

4. To manipulate a parabola, drag its focus or its vertex. To move it, drag it from any other point.

### Creating a Parabola (from focus and directrix)

1. Create a line to serve as the directrix.
2. From the **Shapes** menu, select **Parabola**. (In the Graphs application, click **Geometry > Shapes > Parabola**.)
3. Click a location to establish the focus.
4. Click the line to establish it as the directrix.

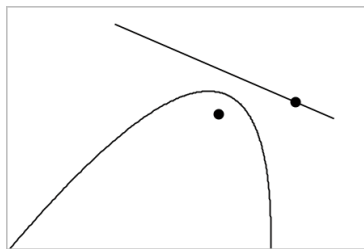

- To manipulate a parabola, rotate or move its directrix or drag its focus. To move it, select both the directrix and the focus, and then drag either object.

### Creating a Hyperbola

- From the **Shapes** menu, select **Hyperbola**. (In the Graphs application, click **Geometry > Shapes > Hyperbola**.)
- Click two locations to establish the foci.
- Click a third location to complete the hyperbola.

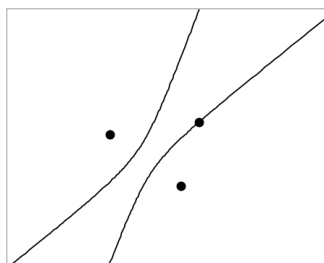

- To manipulate a hyperbola, drag any of its three defining points. To move it, drag it from any other place on the shape.

### Creating a Conic by Five Points

- From the **Shapes** menu, select **Conic by Five Points**. (In the Graphs application, click **Geometry > Shapes > Conic by Five Points**.)
- Click five locations to establish the five points on the shape.

Depending on the pattern of the points, the conic can be a hyperbola or an ellipse.

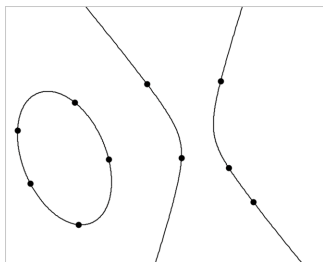

3. To manipulate a conic, drag any of its five defining points. To move it, drag it from any other place on the shape.

### ***Creating Shapes Using Gestures (MathDraw)***

The MathDraw tool lets you use touchscreen or mouse gestures to create points, lines, circles and other shapes.

MathDraw is available in:

- Geometry view without the analytic window displayed.
- Graphing view when the x scale and y scale are identical. This avoids non-circular ellipses and non-square rectangles appearing as circles and squares.

MathDraw is not available in the 3D Graphing view or in the Geometry view with the analytic window displayed.

#### **Activating MathDraw**

1. If using the Geometry view with the analytic window visible, use the **View** menu to hide the window.
2. On the **Actions** menu, select **MathDraw**.

The MathDraw icon  appears. You can begin using the tool.

#### **Cancelling MathDraw**

- ▶ When you have finished using the MathDraw tool, press **Esc**.

The tool also closes if you select a different tool or change views.

#### **Creating Points**

To create a labelled point, tap or click in an open area.

- If the point is close to an existing line, segment, ray, geometric conic (including circles) or polygon, the point snaps to that object. You can also place a point on the intersection of any two of those types of objects.

- If the point is close to a visible grid location in a Graphs view or the analytic window of a Geometry view, it snaps to the grid.

### Drawing Lines and Segments

To create a line or segment, touch or click the initial position, and then drag to the end position.

- If the drawn line passes near an existing point, the line snaps to the point.
- If the drawn line starts close to an existing point and ends next to another existing point, it becomes a segment defined by those points.
- If the drawn line is nearly parallel or perpendicular to an existing line, segment or side of a polygon, it aligns to that object.

**Note:** The default tolerance for detecting parallel/perpendicular lines is 12.5 degrees. This tolerance can be redefined using a variable named **ti\_gg\_fd.angle\_tol**. You can change the tolerance in the current problem by setting this variable in the calculator app to a value in the range 0 through 45 (0=no parallel/perpendicular detection).

### Drawing Circles and Ellipses

To create a circle or ellipse, use the touchscreen or mouse to draw the approximate shape.

- If the drawn shape is sufficiently circular, a circle is created.
- If the shape is elongated, an ellipse is created.
- If the virtual centre of the drawn shape is near an existing point, the circle or ellipse is centred on that point.

### Drawing Triangles

To create a triangle, draw a triangle-like shape.

- If a drawn vertex is close to an existing point, the vertex snaps to the point.

### Drawing Rectangles and Squares

To create a rectangle or square, use the touchscreen or mouse to draw the perimeter.

- If the drawn shape is nearly square, a square is created.
- If the drawn shape is elongated, a rectangle is created.
- If the centre of a square is close to an existing point, the square snaps to that point.



## Drawing Polygons

To create a polygon, tap or click a succession of existing points, ending on the first point you tapped.

### Using MathDraw to Create Equations

In the Graphs view, MathDraw attempts to recognise certain gestures as functions for analytic parabolas.

**Note:** The default step value for quantisation of the parabola coefficients is  $\frac{1}{32}$ . The denominator of this fraction can be redefined using a variable named **ti\_gg\_fd.par\_quant**. You can change the step value in the current problem by setting this variable to a value greater or equal to 2. A value of 2, for example, produces a step value of 0.5.

### Using MathDraw to Measure an Angle

To measure the angle between two existing lines, use the touchscreen or mouse to draw a circle arc from one of the lines to the other.

- If the intersection point between the two lines does not exist, it is created and labelled.
- The angle is not a directed angle.

### Using MathDraw to Find a Mid-point

To create a point midway between two points, tap or click point 1, point 2, and then point 1 again.

### Using MathDraw to Erase

To erase objects, use the touchscreen or mouse to drag left and right, similar to the motion of erasing a whiteboard.

- The erasure area is the bounding rectangle of the erasure gesture.
- All point objects and their dependents inside the erasure area are removed.

## ***Basics of Working with Objects***

### Selecting and Deselecting Objects

You can select an individual object or multiple objects. Select multiple objects when you want to quickly move, colour, or delete them together.

1. Click an object or graph to select it.

The object flashes to indicate selection.

2. Click any additional objects to add them to the selection.
3. Perform the operation (such as moving or setting colour).
4. To deselect all objects, click an empty space in the work area.

### Grouping and Ungrouping Geometric Objects

Grouping objects gives you a way to reselect them as a set, even after you have deselected them to work with other objects.

1. Click each object to add it to the current selection.

The selected objects flash.

2. Display a context menu of the selected object or objects.
3. Click **Group**. You can now select all the items in the group by clicking any of its members.
4. To split a group into individual objects, display a context menu of any of its member objects, and click **Ungroup**.

### Deleting Objects

1. Display the context menu of the object or objects.
2. Click **Delete**.

You cannot delete the origin, the axes, or points representing locked variables, even if those items are included in the selection.

### Moving Objects

You can move an object, group, or combination of selected objects and groups.

**Note:** If an immovable object (such as the graph axes or a point with locked coordinates) is included in a selection or group, you cannot move any of the objects. You must cancel the selection and then select only movable items.

To move this...	Drag this
A multiple-object selection or group	Any of its objects

To move this...	Drag this
A point	The point
A segment or vector	Any point other than an endpoint
A line or ray	The identifying point
A circle	The centre point
Other geometric shapes	Any position on the object except one of its defining points. For example, move a polygon by dragging any of its sides.

### Constraining Object Movement

Holding down the **SHIFT** key before dragging lets you constrain how certain objects are drawn, moved, or manipulated.

Use the constraint feature to:

- Rescale only a single axis in the Graphs application.
- Pan the work area horizontally or vertically, depending on which direction you drag initially.
- Limit object movement to horizontal or vertical.
- Limit point placement to  $15^\circ$  increments as you draw a triangle, rectangle, or polygon.
- Limit angle manipulations to  $15^\circ$  increments.
- Limit the radius of a resized circle to integer values.

### Pinning Objects

Pinning objects prevents accidental changes as you move or manipulate other objects.

You can pin graphed functions, geometric objects, text objects, the graph axes, and the background.

1. Select the object or objects to pin, or click an empty area if you are pinning the background.
2. Display the context menu, and select **Pin**.

A pinned object displays a pin icon  when you point to it.

3. To unpin an object, display its context menu, and select **Unpin**.

**Notes:**

- Although you cannot drag a pinned point, you can reposition it by editing its x and y coordinates.
- You cannot pan the work area while the background is pinned.

**Changing the Line or Fill Colour of an Object**

Colour changes made in the software are displayed in shades of grey when you work on documents using a TI-Nspire™ CX handheld that does not support colour. Colour is preserved when you move documents back to the software.

1. Select the object or objects.
2. Display the object's context menu, click **Colour**, and then click **Line Colour** or **Fill Colour**.
3. Select the colour to apply to the objects.

**Changing the Appearance of an Object**

1. From the **Actions** menu, select **Attributes**.
2. Click the object that you want to change. You can change shapes, lines, graphs, or graph axes.

The list of the attributes for the selected object are displayed.

3. Press **▲** and **▼** to move through the list of attributes.
4. At each attribute icon, press **◀** or **▶** to move through the options. For example, select **Thick**, **Thin**, or **Medium** for the **Line Weight** attribute.
5. Press **Enter** to apply the changes.
6. Press **ESC** to close the **Attributes** tool.

**Labelling Points, Geometric Lines, and Shapes**

1. Display the context menu of the object.
2. Click **Label**.
3. Type the text of the label, and then press **Enter**.

The label attaches itself to the object and follows the object as you move it. The label's colour matches the object's colour.

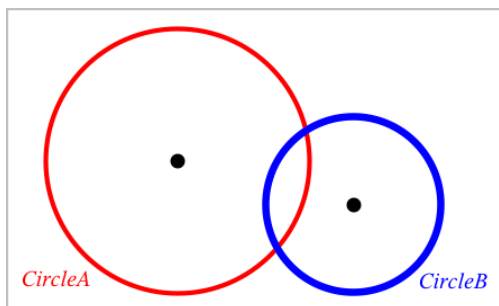

## Measuring Objects

Measurement values update automatically as you manipulate the measured object.

**Note:** Measurements of objects created in the Graphs application are displayed in generic units named  $u$ . Measurements of objects created in the Geometry application are displayed in centimetres ( $cm$ ).

### Measuring Length of a Segment, Circle Arc or Vector

1. From the **Measurement** menu, select **Length**. (In the Graphs application, click **Geometry > Measurement > Length**.)
2. Click the object to display its length.

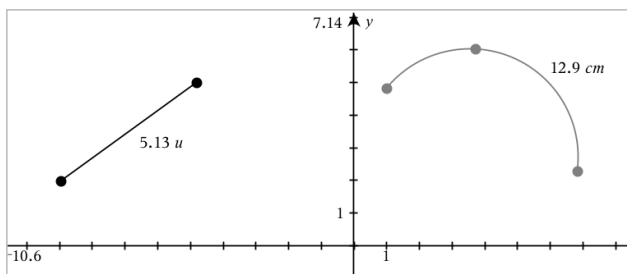

### Measuring Distance Between Two Points, a Point and a Line, or a Point and a Circle

1. From the **Measurement** menu, select **Length**. (In the Graphs application, click **Geometry > Measurement > Length**.)
2. Click the first point.
3. Click the second point or a point on the line or circle.

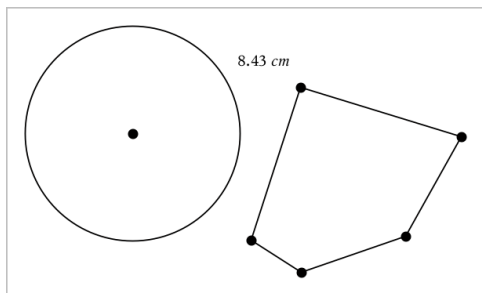

In this example, length is measured from the centre of the circle to the upper left vertex of the polygon.

### Measuring Circumference of a Circle or Ellipse or the Perimeter of a Polygon, Rectangle or Triangle

1. From the **Measurement** menu, select **Length**. (In the Graphs application, click **Geometry > Measurement > Length**.)
2. Click the object to display its circumference or perimeter.

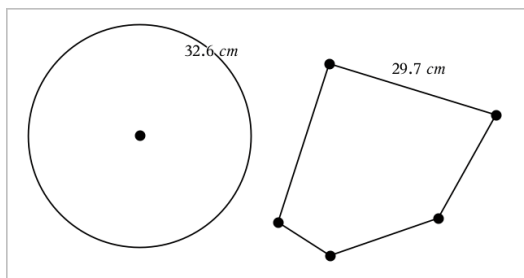

### Measuring a Side of a Triangle, Rectangle or Polygon

1. From the **Measurement** menu, select **Length**. (In the Graphs application, click **Geometry > Measurement > Length**.)
2. Click two points on the object that form the side you want to measure.

**Note:** You must click *two points* to measure a side. Clicking the side measures the entire length of the object's perimeter.

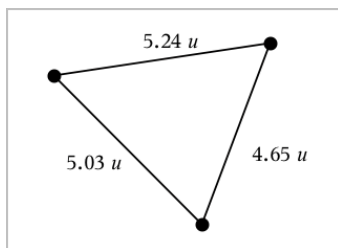

### Measuring Area of a Circle, Ellipse, Polygon, Rectangle or Triangle

**Note:** You cannot measure the area of a polygon constructed using the Segment tool.

1. From the **Measurement** menu, select **Area**. (In the Graphs application, click **Geometry > Measurement > Area**.)
2. Click the object to display its area.

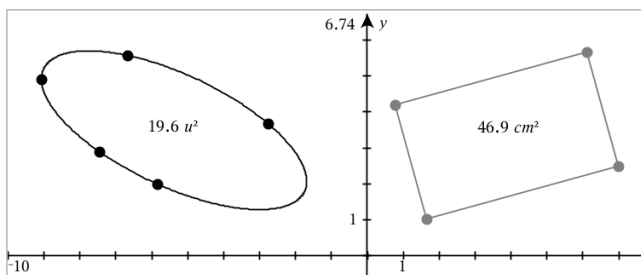

### Measuring Slope of a Line, Ray, Segment or Vector

1. From the **Measurement** menu, select **Slope**. (In the Graphs application, click **Geometry > Measurement > Slope**.)
2. Click the object to display its slope.

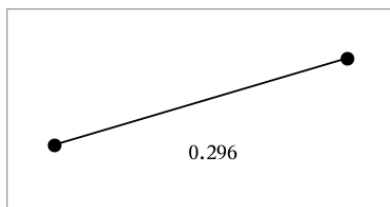

The value is updated automatically when you manipulate the object.

## Measuring Angles

Measured angles in the Geometry application range from  $0^\circ$  to  $180^\circ$ . Measured angles in the Graphs application range from 0 radians to  $\pi$  radians. To change the angle unit, use the **Settings** menu.

1. From the **Measurement** menu, select **Angle**. (In the Graphs application, click **Geometry > Measurement > Angle**.)
2. Click three locations or points to define the angle. The second click defines the vertex.

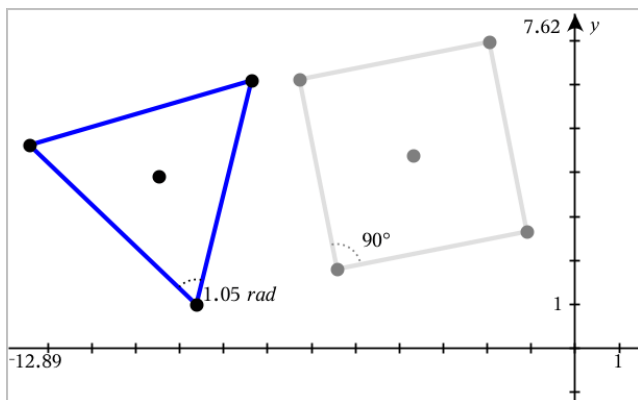

## Measuring Angles using the Directed Angle Tool

1. From the **Measurement** menu, select **Directed Angle**. (In the Graphs application, click **Geometry > Measurement > Directed Angle**.)
2. Click three locations or existing points to define the angle. The second click defines the vertex.

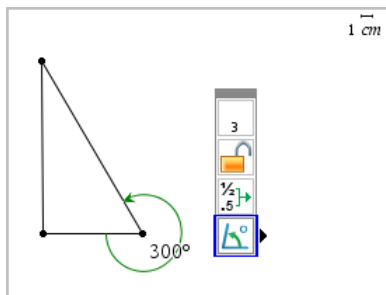

3. To reverse the measurement orientation,



- On the **Actions** menu, select **Attributes**.
- Click the angle text. For example, click  $300^\circ$ .
- Select the orientation attribute, and use the right or left arrow key to change it.
- Press **Esc** to close the Attributes tool.

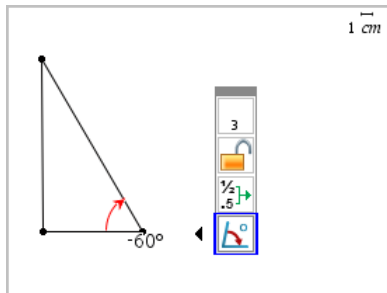

### Moving a Measured Value

- ▶ Drag the measurement to the desired location.

**Note:** If you move a measurement too far from its object, it stops following the object. However, its value continues to be updated as you manipulate the object.

### Editing a Measured Length

You can set the length of a side of a Triangle, Rectangle or Polygon by editing its measured value.

- ▶ Double-click the measurement, and then enter the new value.

### Storing a Measured Value as a Variable

Use this method to create a variable and assign a measured value to it.

- Display the item's context menu, and select **Store**.
- Type a variable name for the stored measurement.

### Linking a Measured Length to an Existing Variable

Use this method to assign a measured length value to an existing variable.

- Display the measurement's context menu, and select **Variables > Link to**.

The menu shows the list of currently defined variables.

- Click the name of the variable you want to link to.

## Deleting a Measurement

- Display the measurement's context menu, and select **Delete**.

## Locking or Unlocking a Measurement

1. Display the measurement's context menu, and select **Attributes**.
2. Use the up/down arrow keys to highlight the Lock attribute.
3. Use the left/right arrow keys to close or open the lock.

As long as the value remains locked, manipulations are not allowed that would require the measurement to change.

## Transforming Objects

You can apply transformations to drawn objects in both the Graphs and Geometry applications. If the object's points are labelled, the corresponding points in the transformed object are labelled using prime notation ( $A \rightarrow A'$ ). To enable automatic labelling of certain objects, see *What You Must Know* in this chapter.

### Exploring Symmetry

1. From the **Transformation** menu, select **Symmetry**. (In the Graphs application, click **Geometry > Transformation > Symmetry**.)
2. Click the object whose symmetry you want to explore.
3. Click a location or existing point to establish the point of symmetry.

A symmetrical image of the object is displayed.

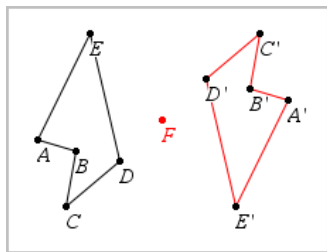

4. Manipulate the original object or the point of symmetry to explore the symmetry.

### Exploring Reflection

1. Create a line or segment to predefine the line about which the object will be reflected.

2. From the **Transformation** menu, select **Reflection**. (In the Graphs application, click **Geometry > Transformation > Reflection**.)
3. Click the object whose reflection you want to explore.
4. Click the predefined reflection line or segment.

A reflected image of the object is displayed.

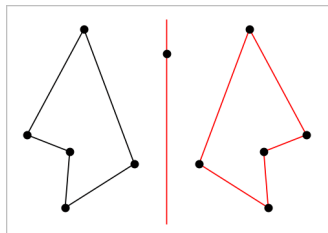

5. Manipulate the original object or the line of symmetry to explore the reflection.

### Exploring Translation

1. (Optional) Create a vector to predefine the distance and direction of translation.
2. From the **Transformation** menu, select **Translation**. (In the Graphs application, click **Geometry > Transformation > Translation**.)
3. Click the object whose translation you want to explore.
4. Click the predefined vector.

—or—

Click two locations on the work area to indicate the direction and distance of translation.

A translated image of the object is displayed.

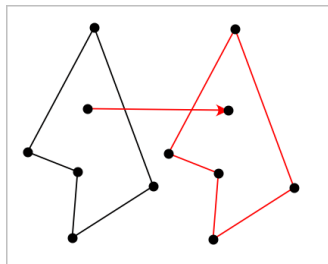

5. Manipulate the original object or the vector to explore the translation.

## Exploring Rotation

1. (Optional) Create an angle measurement to serve as a predefined angle of rotation.
2. From the **Transformation** menu, select **Rotation**. (In the Graphs application, click **Geometry > Transformation > Rotation**.)
3. Click the object whose rotation you want to explore.
4. Click a location or point to define the point of rotation.
5. Click the points of the predefined angle.  
—or—  
Click three locations to define an angle of rotation.

A rotated image of the object is displayed.

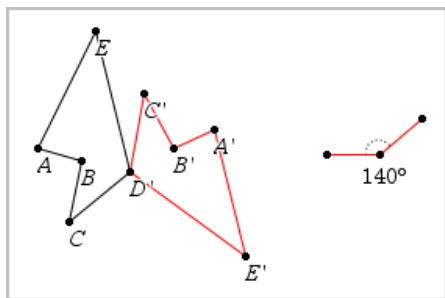

6. Manipulate the original object or the point of rotation to explore the rotation.

## Exploring Dilation

1. Create a Text object containing a numeric value to serve as a predefined dilation factor.

**Note:** You can also use a measured length value as the dilation factor. Keep in mind that if you use a large value, you may have to pan the display to view the dilated object.

2. From the **Transformation** menu, select **Dilation**. (In the Graphs application, click **Geometry > Transformation > Dilation**.)
3. Click the object whose dilation you want to explore.
4. Click a location or existing point to define the centre point of dilation.
5. Click the Text object or measurement that defines the dilation factor.

A dilated image of the object is displayed.

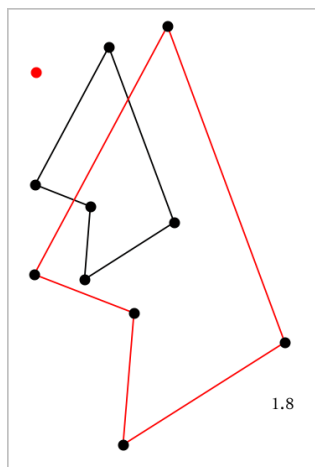

6. Manipulate the original object or the centre point of dilation to explore the dilation. You can also edit the dilation factor.

### ***Exploring with Geometric Construction Tools***

You can investigate scenarios by adding objects from the Construction tools. The constructions are dynamic. The midpoint of a line segment, for example, is updated automatically when you manipulate the endpoints.

While a construction is in progress, a tool appears in the work area (for example, **Parallel** ). To cancel, press **ESC**.

#### **Creating a Midpoint**

This tool lets you bisect a segment or define a midpoint between any two points. The points can be on a single object, on separate objects, or on the work area.

1. From the **Construction** menu, select **Midpoint**. (In the Graphs application, click **Geometry > Construction > Midpoint**.)
2. Click a point or location to define the first point.
3. Click a second point or location to complete the midpoint.

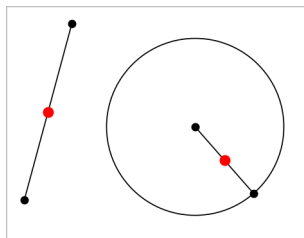

### Creating a Parallel Line

This tool creates a parallel line with respect to any existing line. The existing line can be a Graphs axis or any side of a triangle, square, rectangle, or polygon.

1. From the **Construction** menu, select **Parallel**. (In the Graphs application, click **Geometry > Construction > Parallel**.)
2. Click the object that will serve as the reference line.
3. Click a location to create the parallel line.

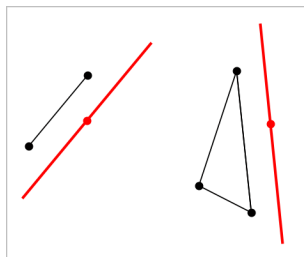

You can drag the parallel line to move it. If you manipulate the reference object, the line remains parallel.

### Creating a Perpendicular Line

You can create a line that is perpendicular to a reference line. The reference can be an axis, an existing line, a segment, or one side of a triangle, rectangle, or polygon.

1. From the **Construction** menu, select **Perpendicular**. (In the Graphs application, click **Geometry > Construction > Perpendicular**.)
2. Click a location or existing point through which the perpendicular line should pass.
3. Click the item that will serve as the reference line.

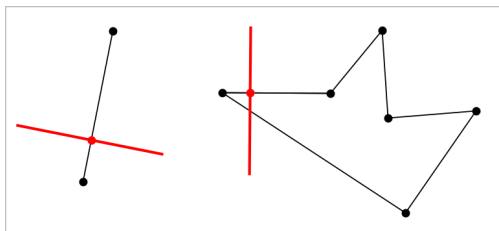

You can drag the intersection point to move the perpendicular. If you manipulate the reference object, the line remains perpendicular.

### Creating a Perpendicular Bisector

You can create a perpendicular bisector on a segment, on one side of a triangle, rectangle, or polygon, or between any two points.

1. From the **Construction** menu, select **Perpendicular Bisector**. (In the Graphs application, click **Geometry > Construction > Perpendicular Bisector**.)
2. Click the item that will serve as the reference line.  
—or—  
Click two points to create a perpendicular bisector between them.

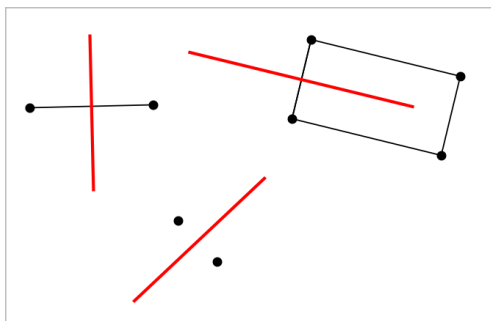

### Bisecting an Angle

This tool creates an angle bisector. The points of the angle can be on existing objects, or they can be locations on the work area.

1. From the **Construction** menu, select **Angle Bisector**. (In the Graphs application, click **Geometry > Construction > Angle Bisector**.)
2. Click three locations or points to define the angle. The second click defines the vertex of the angle.

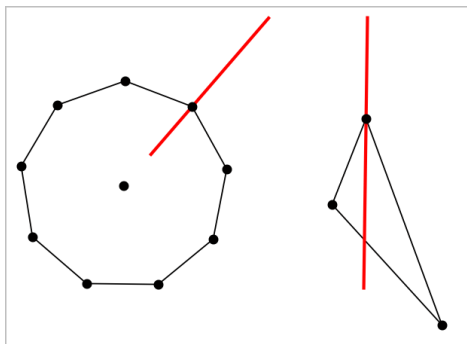

The angle bisector adjusts automatically as you manipulate its defining points.

### Creating a Locus

The Locus tool enables you to explore the range of motion of one object with respect to another object as constrained by a shared point.

1. Create a segment, line, or circle.
2. Create a point on the segment, line, or circle.

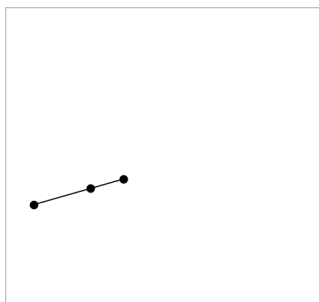

3. Create another object that uses the point created in the previous step.



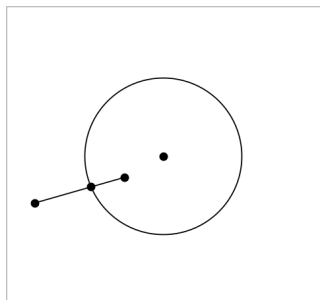

Circle created to use the defined point on the segment.

4. From the **Construction** menu, select **Locus**. (In the Graphs application, click **Geometry > Construction > Locus**.)
5. Click the point shared by the objects.
6. Click the object defined to share the point (this is the object to vary).

The continuous locus is displayed.

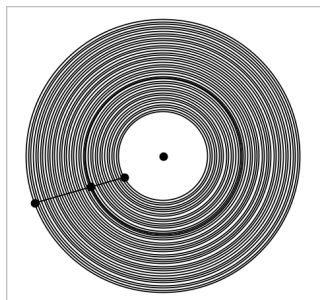

### Creating a Compass

This tool operates similarly to a geometric compass used for drawing circles on paper.

1. From the **Construction** menu, select **Compass**. (In the Graphs application, click **Geometry > Construction > Compass**.)
2. To set the width (radius) of the compass:

Click a segment.

—or—

Click any side of a triangle, rectangle, polygon, or regular polygon.

—or—

Click any two existing points or locations on the work area.

3. Click a location to establish the centre of the circle and complete the construction.

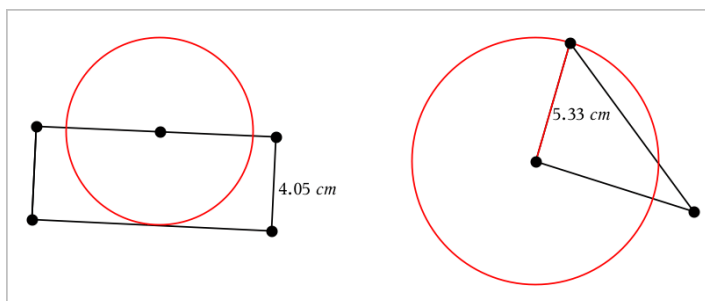

The radius adjusts automatically as you manipulate the original segment, side, or points used to define the radius.

### ***Using Geometry Trace***

The Geometry Trace tool leaves a visible trail of a geometric object or function graph as it is moved or manipulated. The movement can be done manually or by [using animation](#). This tool is accessible in both the Graphs and Geometry applications.

1. From the **Trace** menu, select **Geometry Trace**.

The Geometry Trace tool appears.

2. Click the object or function that you want to trace to select it.
3. Drag the object, or play the animation.

This example shows traces of a graphed function manipulated by dragging and a triangle manipulated by animation.

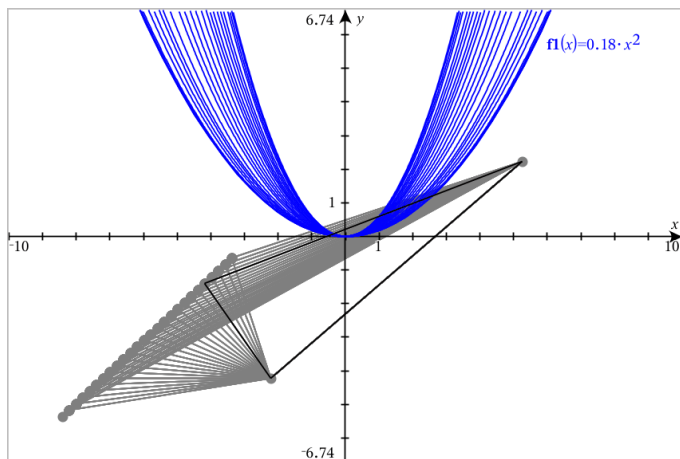

**Note:** You cannot select or manipulate the trace trail.

- To erase all trails, select **Erase Geometry Trace** from the **Trace** menu.
- To stop tracing, press **Esc**.

### **Conditional Attributes**

You can cause objects to hide, show, and change colour dynamically, based on specified conditions such as " $r_1 < r_2$ " or " $\sin(a_1) \geq \cos(a_2)$ ."

For example, you might want to hide an object based on a changing measurement that you have assigned to a variable, or you might want an object's colour to change based on a "Calculate" result assigned to a variable.

Conditional behaviours can be assigned to objects or groups in the Graphing, Plane Geometry, and 3D Graphing views.

#### **Setting Conditional Attributes of an Object**

You can set conditions of a selected object either by using its context menu or by activating the Set Conditions tool from the **Actions** menu and then selecting the object. These instructions describe using the context menu.

- Select the object or group.
- Display the object's context menu, and click **Conditions**.

The conditional attributes are displayed.

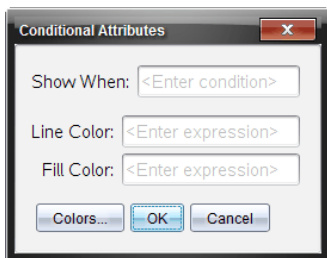

For 2D objects

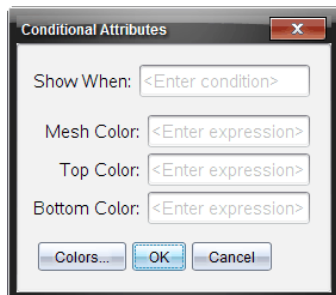

For 3D objects

- (Optional) In the **Show When** field, enter an expression specifying the conditions during which the object will be shown. Anytime the condition is not satisfied, the object will be hidden.

You can specify tolerance by using compound conditionals in the **Show When** input field. For example, **area**>=4 and **area**<=6.

**Note:** If you need to see conditionally hidden objects temporarily, click **Actions > Hide/Show**. To return to normal viewing, press **ESC**.

- (Optional) Enter numbers or expressions that evaluate to numbers in the applicable colour fields, such as **Line Colour** or **Mesh Colour**. To see a map of colour values, click the **Colors** button.

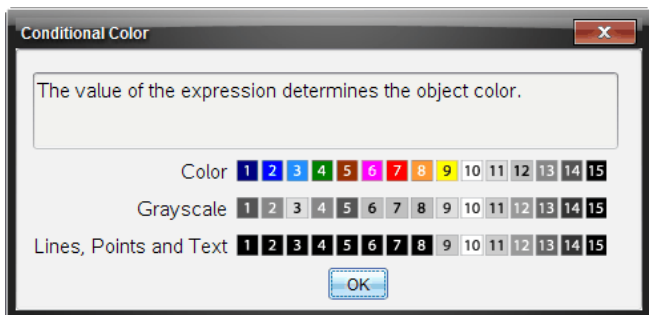

Map of conditional colour values

- Click **OK** in the Conditional Attributes dialogue box to apply the conditions.

## ***Hiding Objects in the Geometry Application***

The Hide/Show tool reveals objects you have previously selected as hidden and lets you select which objects to show or hide.

- From the **Actions** menu, select **Hide/Show**.

The Hide/Show tool appears, and currently hidden items (if any) are shown dimmed.

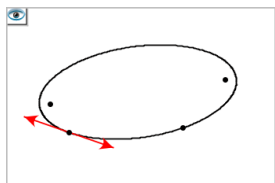

2. Click objects to toggle their hide/show status.

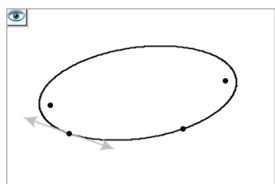

3. Press **Esc** to complete your selections and close the tool.

All objects you selected as hidden objects disappear.

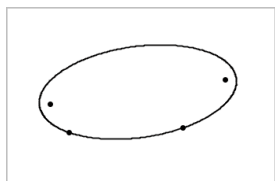

4. To view the hidden objects temporarily or restore them as shown objects, open the Hide/Show tool.

## ***Customizing the Geometry Work Area***

### **Inserting a Background Image**

You can [insert an image](#) as a background for any Graphs or Geometry page.

1. From the **Insert** menu, click **Image**.
2. Navigate to the image you want to insert, select it, and then click **Open**.

### **Adding a Text Object to the Work Area**

Use the Text tool to add numeric values, formulas, observations, or other explanatory information to the Geometry work area.

1. From the **Actions** menu, select **Text**.
2. Click the location for the text.
3. Type the text in the box that appears, and then press **Enter**.

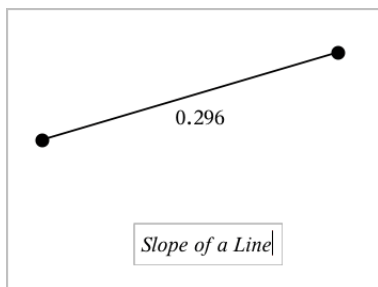

To move a text object, drag it. To edit the text, double-click it. To delete a text object, display its context menu, and select **Delete**.

### Changing the Attributes of Numeric Text



If you enter a numeric value as text, you can lock it or set its format and displayed precision.

1. From the **Actions** menu, select **Attributes**.
2. Click the numeric text to display its list of attributes.
3. Press **▲** and **▼** to move through the list.
4. At each attribute icon, press **◀** or **▶** to move through the options. For example, select **0** through **9** as the precision.
5. Press **Enter** to apply the changes.
6. Press **Esc** to close the Attributes tool.



### Animating Points on Objects

You can animate any point created as a point on an object or graph. Multiple points can be animated simultaneously.

#### Animating a Point

1. From the **Actions** menu, select **Attributes**.
2. Click the point to display its attributes.
3. Press **▼** to select the animation attributes.
4. Press **◀** or **▶** to choose either unidirectional or alternating animation.
5. Type a value to set the animation speed. Any nonzero speed begins the animation. To reverse the direction, enter a negative value.
6. Press **Enter** to display the animation controls  .
7. Press **ESC** to close the Attributes tool.

## Pausing and Resuming All Animations

- ▶ To pause all animations on a page, click **Pause** .
- ▶ To resume all animations, click **Play** .

## Resetting All Animations

Resetting pauses all animations and returns all animated points to the positions they occupied when they were first animated.

- ▶ To reset animation, click **Reset** .

## Changing or Stopping the Animation of a Point

1. Click **Reset**  to stop all animation.
2. From the **Actions** menu, select **Attributes**.
3. Click the point to display its attributes.
4. Select the animation attribute, and type a new animation speed. To stop the point's animation, enter zero.

**Note:** If other animated points exist, the animation controls remain in the work area.

## Adjusting Variable Values with a Slider

A slider control lets you interactively adjust or animate the value of a numeric variable. You can insert sliders in the Graphs, Geometry, Notes and Data & Statistics applications.

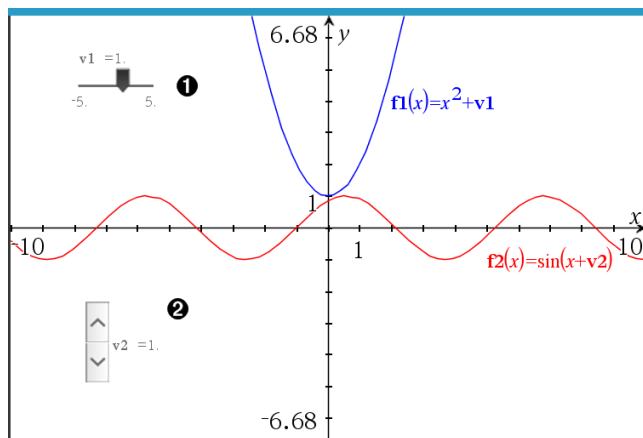

- 1 Horizontal slider for adjusting variable  $v1$ .
- 2 Minimised vertical slider for adjusting variable  $v2$ .

**Note:** TI-Nspire™ version 4.2 or higher is required for opening .tns files containing sliders on Notes pages.

### Inserting a Slider Manually

1. From a Graphs, Geometry or Data & Statistics page, select **Actions > Insert Slider**.  
—or—  
From a Notes page, make sure the cursor is not in a maths box or chem box, and then select **Insert > Insert Slider**.

The Slider Settings screen opens.

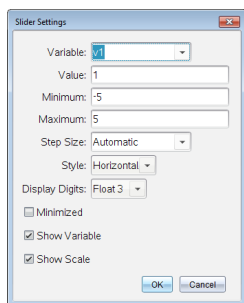

2. Enter the desired values, and click **OK**.

The slider is displayed. On a Graphs, Geometry or Data & Statistics page, handles are displayed to let you move or stretch the slider.

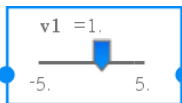

To remove the handles and use the slider, click an empty space in the work area. You can show the handles any time by selecting **Move** from the slider's context menu.

3. To adjust the variable, slide the pointer (or click the arrows on a minimised slider).
  - You can use the **Tab** key to move the focus to a slider or to move from one slider to the next. The colour of the slider changes to show you when it has the focus.
  - When a slider has the focus, you can use the arrow keys to change the value of the variable.

### Working with the Slider

Use the options on the context menu to move or delete the slider, and to start or stop its animation. You can also change the slider's settings.

1. Display the slider's context menu.



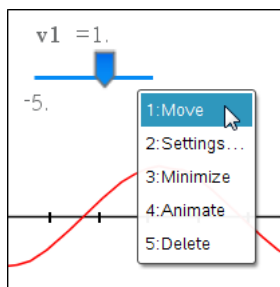

2. Click an option to select it.

### Automatic Sliders in Graphs

Sliders can be created for you automatically in the Graphs application and in the analytic window of the Geometry application. You are offered automatic sliders when you define certain functions, equations or sequences that refer to undefined variables.

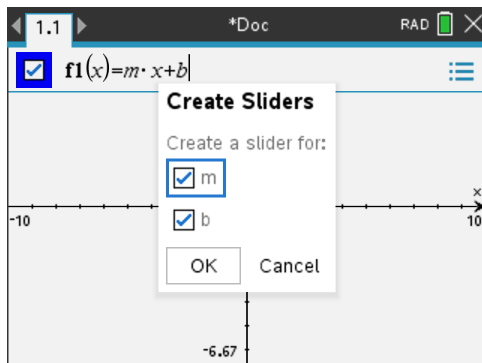

### Using the Calculate Tool

The Calculate tool is available in the Graphs and Geometry applications. It lets you evaluate a maths expression you have entered as a text object.

The following example uses the Calculate tool to calculate the measured angles of a triangle.

1. Using the **Shapes** menu, create a triangle and then measure its angles.

**Tip:** You can enable options to automatically label points and to force geometric triangle angles to integers. For more information, see *What You Must Know*, in this chapter.

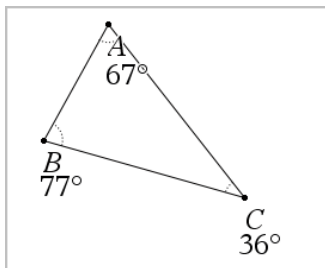

- From the **Actions** menu, click **Text**.
- Click a location for the text, and type the formula for the calculation.

In this example, the formula calculates three terms.

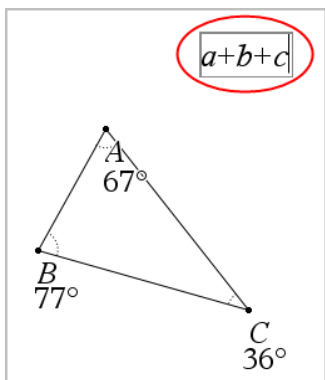

- From the **Actions** menu, click **Calculate**.
- Click the formula you created.

You are prompted to select a value for each term in the formula.

- Click each angle measurement when prompted.

**Note:** If you have stored a measurement as a variable, you can select it when prompted by clicking . If the name of a stored measurement matches a term in the formula, you can press "L" when prompted for that term.

After you have selected the third term, the calculation result attaches itself to the pointer.

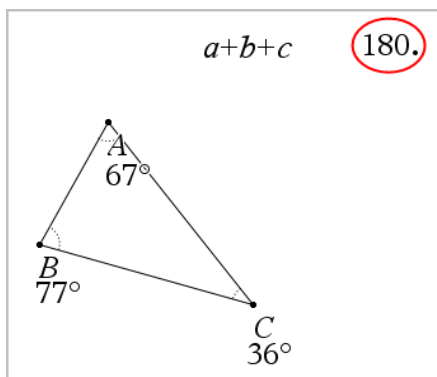

7. Position the result, and press **Enter** to anchor it as a new text object.

# Lists & Spreadsheet Application



The Lists & Spreadsheet application gives you a place to work with tabular data. It lets you:

- Store numeric data, text or maths expressions.
- Define a table cell in terms of the contents of other cells.
- Define an entire column based on the contents of another column.
- Share columns of data as list variables with other TI-Nspire™ applications. Also share individual cells as variables.
- Work with variables created in the Graphs & Geometry and Calculator applications.
- Collect tables of real-world data from sensors.
- Generate columns of data-based sequences that you define.
- Plot table data using the Data & Statistics application.
- Generate a table of values for a function.
- Copy and paste table data from the Lists & Spreadsheet application to other computer applications, such as TI Connect™ software and Excel® spreadsheet software.
- Perform statistical analysis on lists of data.

## Adding a Lists & Spreadsheet Page

- ▶ To start a new document with a blank Lists & Spreadsheet page:

From the main **File** menu, click **New Document** and then click **Lists & Spreadsheet**.

Handheld: Press  **on**, and select **Lists & Spreadsheet** .

- ▶ To add a Lists & Spreadsheet page in the current problem of an existing document:

From the toolbar, click **Insert > Lists & Spreadsheet**.

Handheld: Press  and select **Insert > Lists & Spreadsheet**.

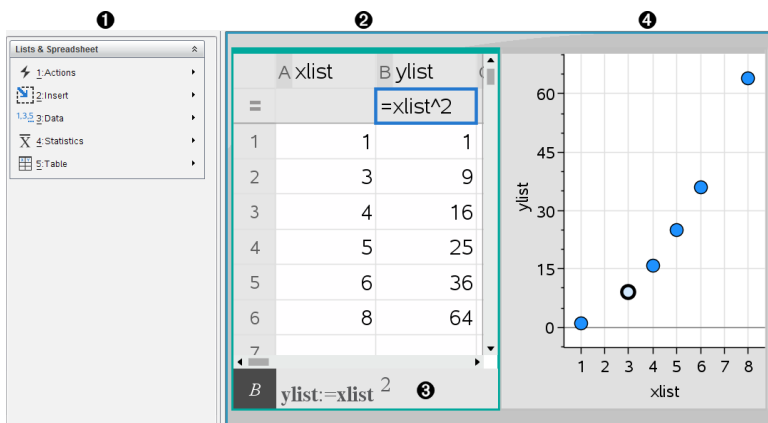

- ❶ Lists & Spreadsheet tools (available when a Lists & Spreadsheet work area is active)
- ❷ Sample Lists & Spreadsheet work area
- ❸ Lists & Spreadsheet entry line
- ❹ Lists & Spreadsheet data plotted in the Data & Statistics application

## Creating and Sharing Spreadsheet Data as Lists

You can define a column as a named list of elements of the same type of data. After defining a list, you can link to it from the Graphs & Geometry, Calculator or Data & Statistics applications, and from other instances of the Lists & Spreadsheet application within the current problem.

**Note:** Lists & Spreadsheet can display a maximum of 2500 elements in a list.

### Sharing a Spreadsheet Column as a List Variable

You share a column of data by naming it as a list variable.

**Note:** Avoid defining variables that use the same names as those used for statistical analysis. In some cases, an error condition could occur.

Variable names used for statistical analysis are listed in the *TI-Nspire™ Reference Guide*, under the **stat.results** entry.

1. Click the cell to move to the column's name cell (the top cell of the column).

—or—

Press  $\blacktriangle$  as necessary.

2. Type a name for the list variable, and press **Enter**.

The column is now available as a list variable to other TI-Nspire™ applications.

3. Create elements in the list the same as you would create data in spreadsheet cells. For example, you can type the data into each cell or use a formula to generate a column of data.

#### Notes:

- If a variable with the name you specified already exists in the current problem, Lists & Spreadsheet displays an error message.
- When you select the column formula cell of a list, it displays the list name in an expression similar to **width:=**.
- Lists can contain empty elements (denoted by “\_”).
- You can refer to a specific element in a named list from the Calculator application. Use the list name and the element’s position within the list. In a list named Heights, for example, refer to the first element as Heights[1]. The expression Heights[2] refers to the second element, and so on.



#### Linking to an Existing List Variable

Linking a column to an existing list variable lets you easily view and edit the values in the list. The list can be any shared list in the current problem and can be defined in Graphs & Geometry, Calculator or any instance of Lists & Spreadsheet.

After you link a column to a list, Lists & Spreadsheet automatically shows any changes that you make to the list with other TI-Nspire™ applications.

1. Click the column formula cell (the second cell from the top) of the column that you want to link to the variable.
2. Type the name of the list variable you want to link to.

—or—

Click  on the toolbar (press  on the handheld), click **Link To** and click the variable you want to link to.

3. Press **Enter**.

The column shows the list elements.

#### Notes:

- You cannot link to the same variable multiple times on the same page.

- Use caution if you link to a system variable. Doing so could prevent the variable from being updated by the system. System variables include *ans* and statistics results (such as *stat.results*, *stat.RegEqn* and *stat.Resid*).

### Inserting an Element in a List

When you insert an element in a list, the remaining elements shift downward to create space. No other columns are affected.

- ▶ Click **Insert > Insert Cell**.

### Deleting an Element from a List

When you delete an element, the remaining list elements shift upward to close the gap. The upward shift affects only the selected column.

1. Click the cell of the element to delete.
2. Open the context menu for the cell, and click **Delete Cell**.

**Note:** If you press **Del** or **Backspace** to clear the contents of the cell instead of deleting the list element, the element is assigned a value of 0 (zero). The remaining list elements do not shift.

## Creating Spreadsheet Data

You can type numeric values, text or formulas into body cells. Column formula cells can contain formulas only. (For more information, see *Generating Columns of Data*.)

### Data Examples

Entry	Remarks
1.234	Simple numeric entry
"Green"	Text - Enclose categorical data (such as the names of colours used in a study) within quotes to distinguish them from variable names. Handheld: Press <input type="checkbox"/> <b>ctrl</b> <input type="checkbox"/> <b>x</b> to enter quoted data.
=a3*length	Formula - Consists of an "=" symbol followed by an expression. You can type the expression or use the Catalogue and expression templates to build it. For more information, see the <i>Calculator</i> section. To ensure a decimal result instead of a fraction, type one of the integers in the expression as a decimal. For example, type <b>1.0</b> instead of <b>1</b> .

## Typing a Maths Expression, Text or Spreadsheet Formula

1. Double-click the cell to select it and put it in edit mode.

**Note:** If the cell is already selected, you can press **Enter** or click the entry line.

2. Type the expression, text or formula. Be sure to enclose text entries in quotes and start formula entries with an “=” symbol.

As you type the data, it appears in the cell and on the entry line simultaneously.

3. Press **Enter** to complete the entry and move down to the next cell.

—or—

Press **Tab** to complete the entry and move right to the next cell.

The Lists & Spreadsheet application automatically recalculates any cells that are dependent on the cell you entered. If you have shared the cell, and other TI-Nspire™ applications are linked to the cell, the other applications are also updated.

**Note:** Empty cells in a spreadsheet display as a void represented by an underscore (\_). The underscore is automatically added to empty cells when a list is named or when an empty cell is referenced in a formula. When you plan to perform calculations on a range of cells, be sure to notice the location of void cells. Cells without a value can affect calculations. For example, if you include a void cell in the range for a sum such as “=b2+c2,” the result of the calculation is void (\_).

## Inserting a Cell Range into a Formula

The Select Range feature lets you insert a cell range (such as a1:b3) into a formula by selecting the range instead of typing cell addresses into an argument.

Suppose you want to calculate the mean of a range of cells.

1. Select the cell that will contain the result.
2. From the **Data** menu, click **List Maths > Mean**.

An editable formula appears in the cell.



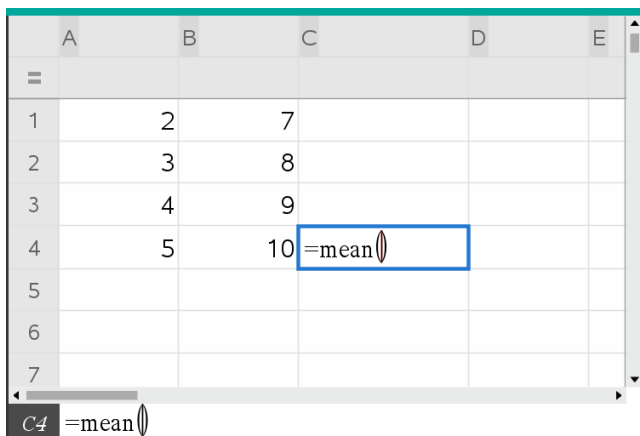

3. Click **Actions > Select > Select Formula Range**.
4. Drag a selection rectangle around the range of values for which you want to calculate the mean.

Handheld: Move to the first cell in the range, hold **⇧shift**, and press the arrow keys.

The formula is updated as you select the cells.

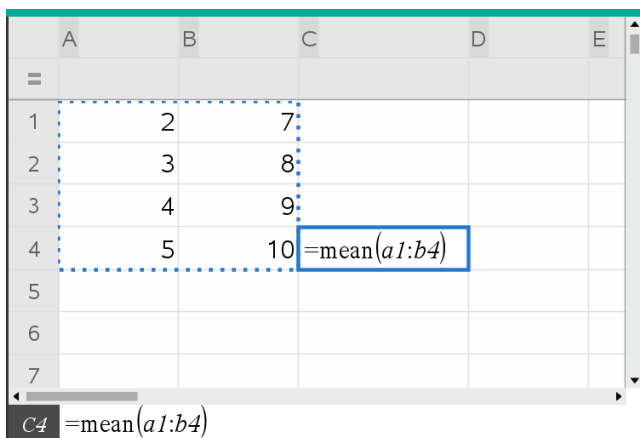

5. Press **Enter** to complete the formula and display the result.

## Navigating in a Spreadsheet

A spreadsheet includes a column letter at the top of each column and a row number on the left of each row. The top two rows and the row numbers remain in place as you scroll. You can name a column of data to make it available as a list variable in TI-Nspire™ applications.

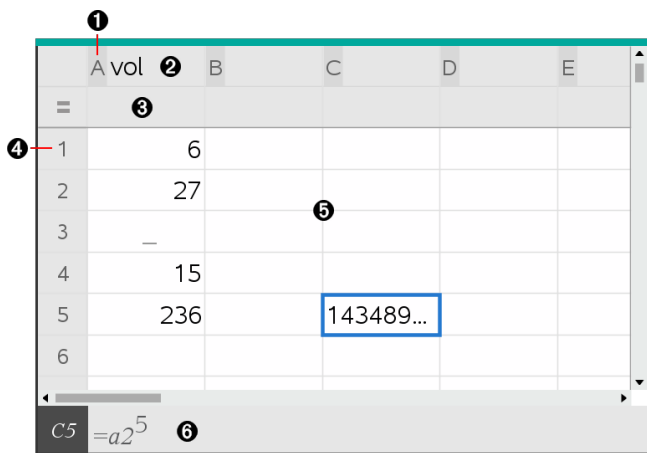

- 1 Column reference letter
- 2 Column name cell for defining a column as a list variable
- 3 Column formula cell for generating a column of data
- 4 Row reference number
- 5 Body Cells - Any empty (void) element in a list is displayed as an underscore ("\_"). Any value that cannot fit in a cell's width is truncated (**143489...**). Hover over the cell to display the complete value.
- 6 Entry line (includes cell reference for current cell)

You can select any cell to view or edit its contents. When a spreadsheet is larger than the Lists & Spreadsheet work area, you can move to different parts of the spreadsheet by using the **Tab** key and by pressing short-cut keys.

- ▶ Press **Tab** to move between the body of the spreadsheet (data zone) and the column names and formulas (naming zone).
- ▶ Press **◀**, **▶**, **▲** and **▼** to move through the spreadsheet one cell at a time (move between cells within a zone). The arrow keys move the cursor from cell to cell and scroll as necessary to keep the selected cell in view.
- ▶ Move across several cells at a time by pressing **Page up**, **Page Dn**, **Home** and **End**.

Handheld: Press **ctrl** **9** (**Page up**), **ctrl** **3** (**Page Dn**), **ctrl** **7** (**Home**) and **ctrl** **1** (**End**) keys.

- ▶ Use the **Go To** command on the **Actions** menu to select a specific cell. Type the cell's column letter and row number (such as **G16**).
- ▶ Press **Enter** to put the selected cell in Edit mode.
- ▶ Drag the scroll bar to move vertically without changing the cell or block of cells selected.

## ***Working with Cells***

### **Working with Colour**

The Lists & Spreadsheet application displays black text and cells with a white background by default. You can change the colour of cells and text to emphasize or distinguish data. The colours and the order in which colour is assigned is based on the TI-Nspire™ colour palette.

#### ***Changing the Fill Colour of Cells***

1. Select the cells to fill with colour. You can choose one or more cells in any adjacent cells, columns or rows.
2. Access the context menu and click **Colour > Fill Colour**.
3. Click the colour to apply to the cells.

**Note:** If you combine colour text and colour cells, choose colours carefully to ensure visibility as you work with documents in the software and on the handheld.

#### ***Changing the Colour of Text***

1. Select the cells that contain the text to change. You can choose one or more cells in any adjacent cells, columns or rows.
2. Access the context menu and click **Colour > Text Colour**.
3. Click the colour to apply to the text. Empty cells in the selection area show the colour change when text is added.

### **Understanding Cell References in Formulas**

Use a cell reference to use data from a cell or range of cells in a formula. The calculation results update automatically when values in cells change.

Relative references include only the cell's column letter and row number (for example, E7). A relative reference describes where a cell is in relation to other cells of the spreadsheet. The Lists & Spreadsheet application keeps track of relative cell references and adjusts the reference automatically when surrounding cells shift (because of actions you perform, such as column deletions or cell insertions).

Follow these guidelines to specify cell references:

- Include a column letter and row number in a relative reference.
- Include the \$ symbol before both the column letter and the row number to specify an absolute reference.
- Include a colon (:) between a two cell reference to specify a range of cells.

Absolute references include the \$ symbol before the column letter and before the row number (for example, \$B\$16). Absolute references always refer to the cell in a specific position in the spreadsheet. The application does not automatically adjust the cell reference when cell positions change.

### Typing a Cell Reference in a Formula

1. Double-click the cell and type the formula. For more information, see the *Calculator* section.
2. Move to the appropriate position in the formula and type the cell reference. Use the format for a relative reference (B3), absolute reference (\$B\$2) or range of cells (A1:A4).

**Note:** You can click **Recalculate** on the **Actions** menu to update all references and formula results in a spreadsheet.

### Deleting the Contents of Cells

1. Click a cell to select it.

—or—

Use the arrow keys to move to the cell.

**Note:** If you are deleting a range of cells, select a cell at one end or corner of the range, and then use **Shift** with the arrow keys to select the remaining cells in the range.

2. Press **Del**.

**Note:** Any cell that uses a formula with an absolute reference to deleted data shows an error. A cell that uses a formula with a relative reference to deleted data is updated to use the data currently in the referenced position.

## Copying Cells

When you copy cells, any formulas in the original cells are copied to the destination cells.

1. Click the cell to copy.

—or—

Use the arrow keys to move to the cell.

**Note:** If you are copying a range of cells, select a cell at one end or corner of the range, and then use **Shift** with the arrow keys to select the remaining cells in the range.

2. Use the standard key short-cut for copying a selection.

Windows®: Press **Ctrl+C**.

Mac®: Press **⌘+C**.

Handheld: Press **ctrl** **C**.

3. Click the cell where you want to duplicate the copied cell. If you are copying a block of data, click the cell that will become the upper left corner of the copied block.

4. Paste the selected cells:

Windows®: Press **Ctrl+V**.

Mac®: Press **⌘+V**.

Handheld: Press **ctrl** **V**.

**Important:** Paste copied data into a cell that is in the same mode as the cell from which the data was originally copied. Otherwise, a formula could paste as a string enclosed in quotes instead of a formula.

## Filling Adjacent Cells

You can repeat a cell's formula or value throughout adjacent cells within the row or column. You can also repeat a range of cells horizontally or vertically. If you fill from a

range that contains a simple sequence (such as 2, 4, 6), the sequence continues in the filled cells.

1. Click the cell that contains the value or formula to repeat.

**Note:** If you are repeating a range of cells, drag to select the range, or select a cell at one end of the range, and then use **Shift** with the arrow keys to select the remaining cells.



2. Click **Data > Fill**.
3. Use the arrow keys, or drag to select the range that will hold the repetitions.
4. Press **Enter**.

The value, formula or pattern that you selected for duplication is repeated over the selected range.

### Sharing a Cell Value as a Variable

You can share the value of a cell with other TI-Nspire™ applications by storing it as a variable. When you define or refer to a shared cell or variable in Lists & Spreadsheet, the name is preceded with an apostrophe (').

1. Click the cell that you want to share.
2. Click  on the toolbar, and click **Store Var** to store the cell's value.

Handheld: Press   or press  and select **Store Var**).

A formula is inserted into the cell with *var* as a placeholder for a variable name.

3. Type over the letters "*var*" with a name for the variable, and press **Enter**. Use a variable name that does not exist in the current problem.

The value is shown in bold to indicate that it is now available as a variable to other TI-Nspire™ applications.

### Linking a Cell to a Variable

When you link a cell to a variable, Lists & Spreadsheet keeps the cell value updated to reflect the current value of the variable. The variable can be any variable in the current problem and can be defined in Graphs & Geometry, Calculator, Data & Statistics or any instance of Lists & Spreadsheet.

1. Click the cell that you want to link to a variable.
2. Click  on the toolbar, and click **Link to**.

Handheld: Press **ctrl** **var** or press **var** and select **Link to**.

The VarLink menu opens.

3. Under **Link To**, press **▲**, and **▼** to scroll to the name of the variable.
4. Press **Enter**.

The cell shows the value of the variable.

**Note:** Use caution if you link to a system variable. Linking could prevent the variable from being updated by the system. System variables include statistics results (such as *Stat.RegEqn*, *Stat.dfError* and *Stat.Resid*) and finance-solver variables (such as *tvm.n*, *tvm.pmt* and *tvm.fv*).

## **Working with Rows and Columns of Data**

### **Selecting a row or column**

- ▶ To select a column, move to the top of the column and click the column reference letter. To select a row, move to the leftmost cell of the row and click the row reference number. Press **Esc** to cancel the selection.

**Handheld:** Hold down **▲** to move past the top cell, or hold down **◀** to move past the leftmost cell.

- ▶ To extend a selection to adjacent rows or columns, hold down **Shift** and press **◀**, **▶**, **▲** or **▼**.

### **Resizing a Row or Column**

1. Click the row or column that you want to resize.
2. From the **Actions** menu, select **Resize** and then select an option.
3. Choose a resizing option for a column or row.
  - For a column, choose **Resize Column Width**, **Maximize Column Width** or **Minimise Column Width**.
  - For a row, you can choose **Resize Row Height**.

The tools that minimise and maximise the column width work automatically. You must manually adjust the size to use the **Resize Column Width** and **Resize Row Height** tools.

4. To resize manually, use **◀** and **▶** to resize the column, or use **▲** and **▼** to resize the row, and then press **Enter**.

## Inserting an Empty Row or Column

1. Click a column or row where you want to insert the new data.
2. From the **Insert** menu, select either **Row** or **Column**.
  - If you are inserting a row, the remaining rows shift down to create space for the new row.
  - If you are inserting a column, the remaining columns shift right to create space.

**Note:** If other cells contain formulas with relative references to a displaced row or column, those references adjust accordingly.

## Deleting Entire Rows or Columns

You can delete a row, column, group of rows or group of columns. When you delete a row or column, the remaining rows or columns move up or left to fill the gap.

1. Click the column or row that you want to delete.
2. (Optional) To select adjacent rows or columns to delete, hold down **Shift** and press **◀**, **▶**, **▲** or **▼**.
3. Display the context menu.
  - Windows®: Right-click the selected row.
  - Mac®: Hold the **⌘** key, and click the selected row.
  - Handheld: Press **ctrl** **menu**.
4. On the context menu, select **Delete Row**.

The selected rows or columns are deleted.

**Note:** If other cells contain formulas that refer to the deleted row or column, those cells show an error. Relative references to cells whose positions have changed because of a deletion adjust accordingly.

## Copying Rows or Columns

1. Click the row number to copy a row, or click the column letter to copy a column.
2. (Optional) To select adjacent rows or columns to copy, hold down **Shift** and press **◀**, **▶**, **▲** or **▼**.
3. Copy the row or column:

Windows®: Press **Ctrl+C**.

Mac®: Press **⌘+C**.



Handheld: Press **ctrl** **C**.

4. Move to any cell in the row or column where you want to place the copied items.
5. Paste the row or column:

Windows®: Press **Ctrl+V**.

Mac®: Press **⌘+V**.

Handheld: Press **ctrl** **V**.

The copied row or column is pasted in place, replacing the previous contents.

**Note:** If you copy a named column, it is pasted with the name removed to prevent a variable conflict.

### Moving a Column

1. Click the column that you want to move.
2. From the **Actions** menu, select **Move Column**.

An insertion bar appears.

3. Press **◀** and **▶** to place the insertion bar at the column's new position, and then press **Enter**.

**Note:** Relative references to any cell in a position is affected by the move adjust accordingly.

### Displaying Results as Exact or Approximate

You can choose to display a column's calculated results in Exact (fraction) or Approximate (decimal) form. This affects only the values calculated from a formula.

1. Select the column by clicking the reference letter at the top of the column.

Handheld: Hold down **▲** to move past the top cell.

2. Display the context menu for the column.
3. On the context menu, click either **Data > Exact** or **Data > Approximate**.

**Note:** To restore the column results to the document's default setting, select the column and click **Data > Restore Document Setting**.

## Clearing Column Data

The Clear Data command lets you remove the data from selected columns. Clear Data does not delete the column, and it does not clear a column's name or formula.

After clearing the data, Lists & Spreadsheet recalculates column formulas for the selected columns. This makes Clear Data useful for capturing a fresh set of data from another application or selectively generating a fresh column of random numbers.

1. Click the column or columns that you want to clear.
2. From the **Data** menu, select **Clear Data**.

**Note:** If a recalculated formula produces the same data as before, it may appear that the Clear Data command has failed.

## Sorting Data

You can sort a selected area of the spreadsheet in ascending or descending order. You select which column in the selected area will be used as the key for the sort. When the sort moves data up or down in the key column, the corresponding data in the other selected columns is also moved up or down. This preserves the integrity of each row.

**Note:** Sorting is based on numeric values. If you select a key column that contains text, you could get unexpected results.

1. Select the range of cells.

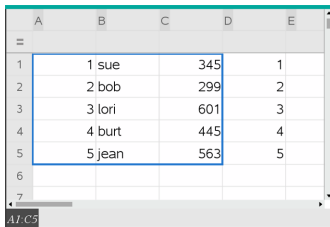

	A	B	C	D	E
1	1	sue	345	1	
2	2	bob	299	2	
3	3	lori	601	3	
4	4	burt	445	4	
5	5	jean	563	5	
6					
7					

2. From the **Actions** menu, select **Sort**.

The **Sort** dialogue box opens.

3. Click the column letter to use for ordering.
4. Click **Descending** or **Ascending** as the sort method, and then click **OK**.

	A	B	C	D	E
=					
1		5 jean	563	1	
2		4 burt	445	2	
3		3 lori	601	3	
4		2 bob	299	4	
5		1 sue	345	5	
6					
7					

**Note:** Sorting a column that is defined by a formula will remove the formula, because it may not be valid after the sort.

## Generating Columns of Data

You can create a column of values based on the contents of another column. You can also create a column based on any of several types of sequential data.

Entering a formula in a column's formula cell tells the Lists & Spreadsheet application that you want to apply the formula to all cells in the column, not just to a single cell.

	A	B ①	C ②	D ③	
=		=xbar*2	=a[]/2	=seqgen(u(n-1)+u(n	
1		1	25.	0.5	1
2		5	25.	2.5	5
3		15	25.	7.5	6
4		45	25.	22.5	11
5		7	25.	3.5	17
6			25.		28
7			25.		45

D =seqgen(u(n-1)+u(n-2),n,u,{1,255},{1,5},1)

- ① Column formula based on a variable
- ② Column formula based on another column (column A)
- ③ Column formula that generates a sequence

### Notes:

- If you generate data in a column that already contains one or more cell values, Lists & Spreadsheet asks for confirmation before replacing the existing values. Proceeding removes all of the existing values in the column.
- If you edit a cell manually in a column of generated data, Lists & Spreadsheet asks for confirmation before replacing the generated data. Proceeding removes the generated data for the entire column.

## Creating Column Values Based on Another Column

1. Click the column formula cell (the second cell from the top) of the column where you want to use a formula.

Lists & Spreadsheet inserts the leading equal sign (=) for the formula. If the column is a named list, Lists & Spreadsheet inserts *listname:=* followed by the cursor.

2. Type the expression for the formula after the = and press **Enter**. Use brackets ([]) after any column letter you include in the formula. For example, type **=a[]^2** to create a column of values in which each cell is the square of the corresponding cell of column A.

Lists & Spreadsheet shows the formula in the formula cell and fills the column with the results.

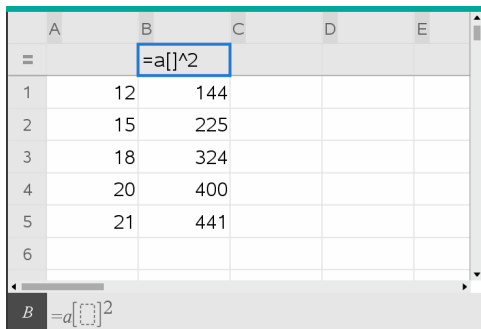

	A	B	C	D	E
=		=a[]^2			
1	12	144			
2	15	225			
3	18	324			
4	20	400			
5	21	441			
6					

## Generating a Column of Random Numbers

This example generates a column of 20 random integers in the range 1 to 6.

1. Click the column formula cell (the second cell from the top) of the column.

Lists & Spreadsheet inserts the leading equal sign (=) for the formula. If the column is a named list, Lists & Spreadsheet inserts *listname:=* followed by the cursor.

2. After the equal sign, type **RandInt ( 1 , 6 , 20 )**.

**Note:** You can also use the Catalogue or click **Data > Random > Integer** to insert the **RandInt()** function.

3. Press **Enter** to generate the numbers.

	A	B	C	D
=	=randint(1,6,20)			
1		6		
2		6		
3		1		
4		4		
5		3		
6		5		
7		1		

4. Generate (Recalculate) a new set of random numbers:

Windows®: Press **Ctrl+R**.

Mac®: Press **⌘+R**.

Handheld: Press **ctrl** **R**.

### Generating a Numerical Sequence

1. Click any cell in the column in which you want to generate the sequence.
2. From the **Data** menu, select **Generate Sequence**.

The Sequence dialogue box opens.

3. Type the **Formula** that will be applied to the column values.
4. Type any **Initial Terms** required by the sequence. Separate them with commas.
5. Type a starting value for the independent variable (**n0**).
6. Type a maximum number of values to be generated (**nMax**).
7. Type the step value (**nStep**).

8. (Optional) Type a maximum value for the sequence in the **Ceiling Value** field.
9. Click **OK**.

Lists & Spreadsheet shows the formula in the formula cell and fills the column with the results.

A	B	C
=seqgen(n^2,n,u,{1,255},{2},1,50)		
1	2	
2	4	
3	9	
4	16	
5	25	
6	36	

## Graphing Spreadsheet Data

You can graph the data in a spreadsheet using Quick Graph or Summary Plot. Lists & Spreadsheet cells that contain no data are not represented by data points on graphs.

### Using Quick Graph

You can easily create a dot plot of the data in one column or a scatter plot of two adjacent columns by using the Quick Graph feature. This feature displays the graphed data using the Data & Statistics application.

To create a scatter plot:

1. Name both of the columns to declare them as lists.

A xlist	B ylist	C	D	E
1	2			
2	4			
3	8			
4	16			
5	32			
6				
7				

2. Select both columns.

	A xlist	B ylist	C	D	E
=					
1	1	2			
2	2	4			
3	3	8			
4	4	16			
5	5	32			
6					
7					

- From the **Data** menu, select **Quick Graph**.

A Data & Statistics application is added to the page with the plotted data. The leftmost of the two lists is plotted on the x axis, and the other list is plotted on the y axis.

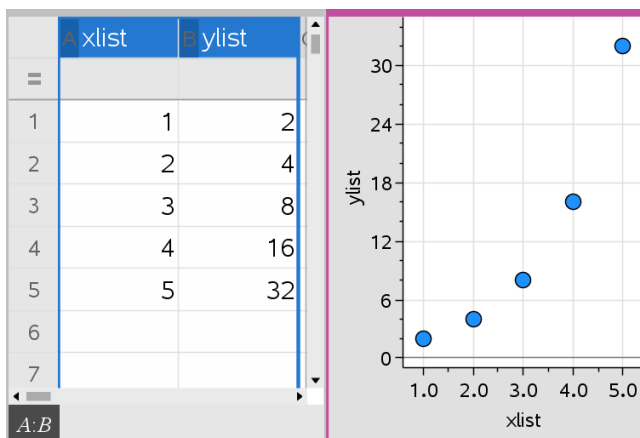

- (Optional) Use the Data & Statistics features to analyse or visually enhance the graph.

**Note:** For more information, see *Using Data and Statistics*.

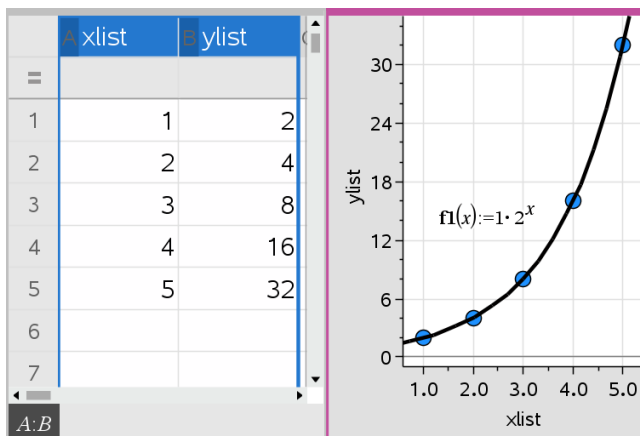

### Creating a Summary Plot from a Summary Table

In this example, you create a summary table from raw data, and then use the table to generate a summary plot. For more information, see *Using Data & Statistics*.

	A person	B ht	C wt	D eyecolor	E gender	F
1	1	56	130	blue	f	
2	2	55	150	blue	m	
3	3	60	200	green	f	
4	4	62	270	brown	m	
5	5	65	250	brown	f	
6	6	71	187	green	m	
7	7	62	176	brown	m	

raw data

	A color	B counts	C	D	E
1	blue	3			
2	green	3			
3	brown	4			
4					
5					
6					
7					

summary table for eye colour based on raw data

A summary table contains an X (or Y) List and a Summary List.

- The X (or Y) List contains numeric or string values (such as 1999 or “colour”). Numeric values result in a histogram. String values identify the categories for a bar chart.
- The Summary List contains numeric values (such as count, frequency, or probability) for each element in the other list.



### To Create a Summary Plot:

**Note:** For situations in which you already have a summary table, you can skip the first two steps.

1. Create a list that holds the category identifiers. For this example, name the list “colour” and type strings for eye colour. Enclose category names in quotes to prevent them from being interpreted as variables.

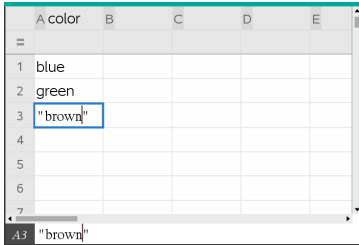

2. Create the summary list. For this example, name the list “counts” and type the total count for each of the eye colours.

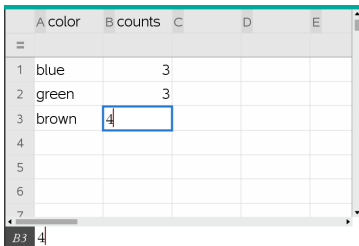

3. Select either list by clicking the top cell of the column and pressing ▲.
4. From the **Data** menu, select **Summary Plot**.

The Summary Plot dialogue box opens.

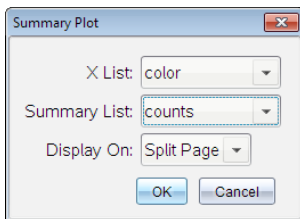

5. If necessary, use **Tab** and the arrow keys to select the correct lists for **X List** and **Summary List**.

6. In the **Display On** field, select how to display the summary plot in the Data & Statistics application.
- Select **Split Page** to place the chart on half of the current page.
  - Select **New Page** to add the chart on a new page.

The summary plot is displayed with the list names along the axes and a summary plot symbol in the lower left corner of the chart window.

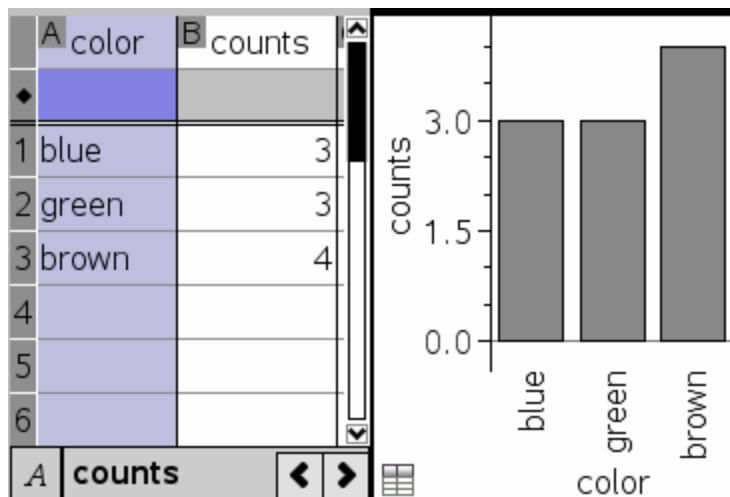

**Note:** In this example, the X List contains string data, so the summary plot displays as a bar chart. The category strings from the list display beneath the bars.

### ***Exchanging Data with Other Computer Software***

You can use the TI-Nspire™ desktop software to copy table data to and from software outside the TI-Nspire™ applications, such as TI DataEditor (in the TI Connect™ software) and Excel® spreadsheet software.

For example, you can copy:

- The values of individual cells, a range of cells or an entire list from TI DataEditor.
- The values (not the underlying formulas) of individual cells, a range of cells or an entire column from an Excel® spreadsheet.
- A number from TI DataEditor.
- The value of a matrix from TI DataEditor.

#### **Example - Copying Data from TI DataEditor**

1. Open the TI Connect™ software.

2. Display the TI DataEditor.
3. If necessary, open the file containing the number, list or matrix that you want to copy.

	$L_6$
1	1.5567
2	2.2256
3	3.987
4	7.5326
5	13.33
6	

4. Drag to select the values that you want to copy. To copy an entire list, click the top cell in the list.

	$L_6$
1	1.5567
2	2.2256
3	3.987
4	7.5326
5	13.33
6	

5. Click **Edit > Copy**.
6. In Lists & Spreadsheet, click the cell where you want the data to be pasted.

If you have copied a range of cells, they will be pasted so that the upper-left corner of the range is positioned at the selected cell. Any data in those cells will be overwritten.

7. Click **Edit > Paste**.

	A	B	C	D	E
=					
1		1.5567			
2		2.2256			
3		3.987			
4		7.5326			
5		13.33			
6					
7					

### Copying Cells from an Excel® Spreadsheet

You can copy up to 26 columns and 2500 rows from an Excel® spreadsheet to a Lists & Spreadsheet application.

1. Drag to select the values that you want to copy from the Excel® spreadsheet. To copy an entire column, click the column identifier at the top of the column.

**Note:** If you select non-contiguous columns in the Excel® spreadsheet, they will be pasted as contiguous columns in Lists & Spreadsheet.

2. Use the standard key short-cut for copying a selection.

Windows®: Press **Ctrl+C**.

Mac®: Press **⌘+C**.

3. In Lists & Spreadsheet, click the cells where you want the data to be pasted.

If you are copying a range of cells, they will be pasted so that the upper-left corner of the range is positioned at the selected cell. Any data in those cells in will be overwritten.

4. Paste the data.

Windows®: Press **Ctrl+V**.

Mac®: Press **⌘+V**.

Handheld: Press **ctrl** **V**.

**Note:** Categorical data must be enclosed in quotes (“ ”) after the data is pasted.

## Capturing Data from Graphs & Geometry

You can use Lists & Spreadsheet application to capture information about objects in the Graphs & Geometry application. For example, you could track changes in the area of a triangle as you change the length of a side in the Graphs & Geometry application.

Captured values replace values in the column. If you prefer, you can remove all data from a column before starting a new capture by clicking **Clear Data** on the **Data** menu.

### Capturing Data Manually

1. Make sure the data value that you want to capture is linked to a variable name.
2. Click the column formula cell (the second cell from the top) of the column in which you want to capture the values.

**Note:** Captured values replace values in the column.

3. Click **Data > Data Capture > Manual**.

A capture expression is inserted into the column formula cell with *var* as a placeholder for the name of the variable you are capturing.

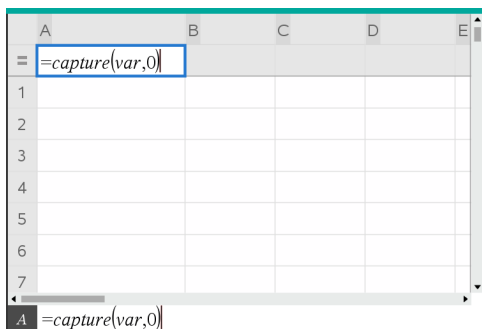

4. Replace the letters “*var*” with the name of the variable to capture from Graphs & Geometry. For example, type **area**.

The formula cell now contains an expression similar to `=capture(area,0)`.



**Note:** The argument “0” tells Lists & Spreadsheet that you want to trigger each capture manually.

5. Press **Enter**.

6. From the Graphs & Geometry application, change the object with a measured value stored as the variable (area, in this example) referenced in the data capture expression.
7. Each time you are ready to capture the current value of area, press the capture keys.

Windows®: Press **Ctrl+.** (the full stop key).

Mac®: Hold down **⌘** and press **.** (the full stop key).

Handheld: Press **ctrl** **.**.

The current *area* value is added to the end of the list as a list element.

### Capturing Data Automatically

When you capture data automatically, you can specify that you want the captures to be triggered by:

- Changes in the captured variable only.
- Changes in the captured variable or additional variables.

This lets you set up multiple columns of synchronised captures, such as the x and y coordinates of a moving object.

1. Clear all columns that you will be using for the captured data.
2. Make sure any data values that you want to capture are linked to variable names.
3. Click the column formula cell (the second cell from the top) of the column in which you want to capture the values.
4. Click **Data > Data Capture > Automatic**.

A capture expression is inserted into the column formula cell with *var* as a placeholder for the name of the variable you are capturing.

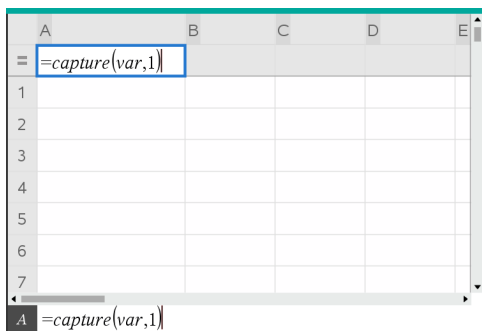

5. Replace the letters “var” with the name of the variable to capture. For example, type `objpathX`. Alternatively, you can select the variable name from the Variables menu.

The formula cell now contains an expression similar to `=capture(objpathX,1)`.



**Note:** The argument “1” tells Lists & Spreadsheet that you want the captures to be triggered by the variable change.

6. If you want the capture to also be triggered by changes in an additional variable or variables, type a comma after the 1, and then type the variable name or the name of a list that itemises the variables.

The formula cell will contain an expression similar to `=capture(objpathX,1,objpathY)`.

7. Press **Enter** to complete the formula.
8. If you are capturing multiple columns of synchronised data, set up the additional columns. For example, you might set up a second capture variable using `=capture(objpathY,1,objpathX)`.
9. When you are ready to capture the values, begin moving the object or start the animation that affects it in Graphs & Geometry.

Each captured value is added to the end of the list.

### Synchronising Captured Data for a Point

To ensure that both coordinate values for a point are captured even if only one coordinate changes, you can add `{ 'a', 'b' }` in the third argument of the capture expression.

1. In a Graphs & Geometry application, create a point with variables (a,b).

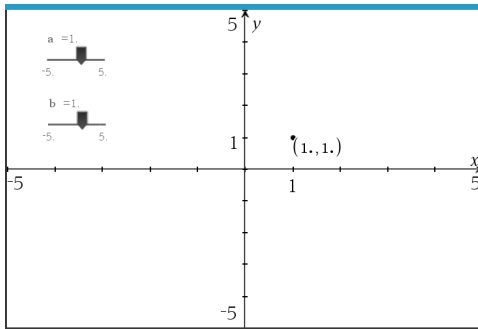

2. Add a Lists & Spreadsheets application to the problem.
3. Enter the capture expressions for both variables.

Column A: `=capture('a,1,{ 'a','b' })`

Column B: `=capture('b,1,{ 'a','b' })`

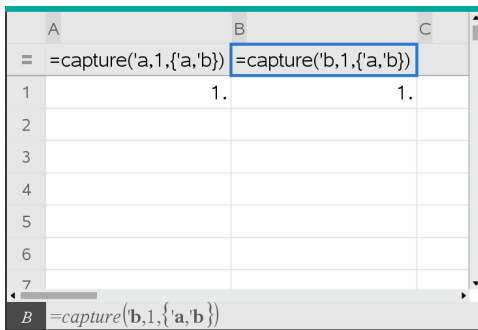

4. Move the slider for variable a.

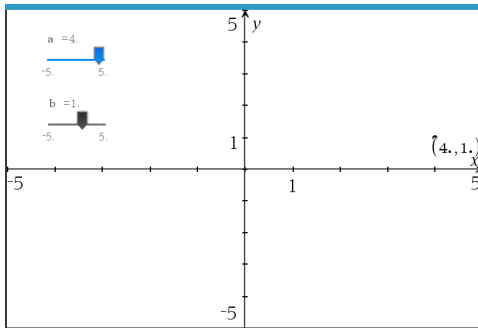



The data captured for **b** synchronises accordingly.

A	B	C
=capture('a,1',{'a','b'}) =capture('b,1',{'a','b'})		
1	1.	1.
2	2.	1.
3	3.	1.
4	4.	1.
5	4.	2.
6	4.	3.
7		

5. Move the slider for variable **b**.

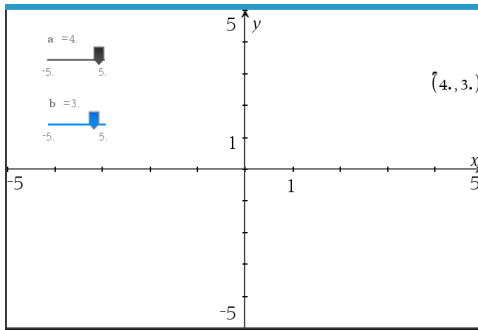

The data captured for **a** synchronises accordingly.

A	B	C
=capture('a,1',{'a','b'}) =capture('b,1',{'a','b'})		
1	1.	1.
2	2.	1.
3	3.	1.
4	4.	1.
5	4.	2.
6	4.	3.
7		

## Using Table Data for Statistical Analysis

Tools on the Statistics menu provide access to wizards that help you perform statistical analyses on the data in table columns. You specify the location of the data, and Lists & Spreadsheet stores the results in two columns: one for the result names, and one for the corresponding values.

### Plotting Statistical Data

Some statistics wizards include a **Draw** box. By default, the box is not selected. Selecting this box creates a Data & Statistics work area on the page, displays the calculated results in Lists & Spreadsheet, and draws the results of the statistical analysis in the Data & Statistics work area.

**Note:** For functions that support the **Draw** option, the option is available only if you type the function in a column formula cell.

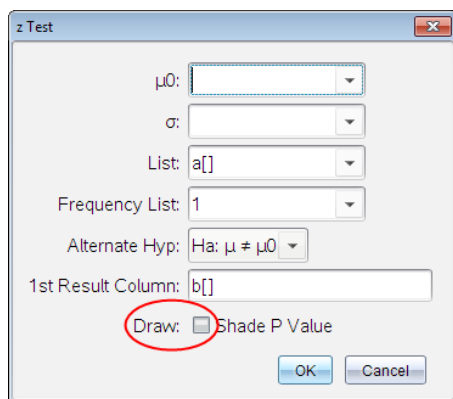

**Draw** box (as shown in the **z Test** wizard).

## Statistics Input Descriptions

The following table describes the different inputs used in Lists & Spreadsheet wizards.

Input	Description
$\mu_0$	Hypothesized value of the population mean that you are testing.
$\sigma$	The known population standard deviation; must be a real number $> 0$ .
List	The name of the list containing the data you are testing.
Frequency List	The name of the list containing the frequency values for the data in <b>List</b> . Default=1. All elements must be integers $\geq 0$ . The frequency values can also be typed as a list, in the format {1, 1, 3,

Input	Description
	2}.
$\bar{x}$ , $S_x$ , $n$	Summary statistics (mean, standard deviation and sample size) for the one-sample tests and intervals.
$\sigma_1$	The known population standard deviation from the first population for the two-sample tests and intervals. Must be a real number $> 0$ .
$\sigma_2$	The known population standard deviation from the second population for the two-sample tests and intervals. Must be a real number $> 0$ .
List 1, List 2	The names of the lists containing the data you are testing for the two-sample tests and intervals.
Frequency 1, Frequency 2	The names of the lists containing the frequencies for the data in <b>List 1</b> and <b>List 2</b> for the two-sample tests and intervals. Defaults=1. All elements must be integers $\geq 0$ .
$\bar{x}_1$ , $S_{x1}$ , $n_1$ , $\bar{x}_2$ , $S_{x2}$ , $n_2$	Summary statistics (mean, standard deviation, and sample size) for sample one and sample two in two-sample tests and intervals.
Pooled	Specifies whether variances are to be pooled for <b>2-Sample t Test</b> and <b>2-Sample t Interval</b> .
$p_0$	The expected sample proportion for <b>1-Prop z Test</b> . Must be a real number, such that $0 < p_0 < 1$ .
$x$	The count of successes in the sample for the <b>1-Prop z Test</b> and <b>1-Prop z Interval</b> . Must be an integer $\geq 0$ .
$n$	The count of observations in the sample for the <b>1-Prop z Test</b> and <b>1-Prop z Interval</b> . Must be an integer $> 0$ .
$x_1$	The count of successes from sample one for the <b>2-Prop z Test</b> and <b>2-Prop z Interval</b> . Must be an integer $\geq 0$ .
$x_2$	The count of successes from sample two for the <b>2-Prop z Test</b> and <b>2-Prop z Interval</b> . Must be an integer $\geq 0$ .
$n_1$	The count of observations in sample one for the <b>2-Prop z Test</b> and <b>2-Prop z Interval</b> . Must be an integer $> 0$ .
$n_2$	The count of observations in sample two for the <b>2-Prop z Test</b> and <b>2-Prop z Interval</b> . Must be an integer $> 0$ .

Input	Description
C-Level	The confidence level for the interval instructions. Must be $\geq 0$ and $< 100$ . If it is $\geq 1$ , it is assumed to be given as a percent and is divided by 100. Default=0.95.
RegEq	The prompt for the name of the function where the calculated regression equation is to be stored.

## Statistical Calculations

### Performing a Statistical Calculation

You can perform statistical calculations to analyse data. The following example fits a  $y=mx+b$  linear regression model to the two lists in columns A and B.

1. From the **Statistics** menu, select **Stat Calculation > LinearRegression (mx+b)** to choose the regression model.

The Linear Regression (mx+b) dialogue box opens.

2. Type **a []** as the column for the **X List**.
3. Type **b []** as the column for the **Y List**.
4. To store the regression equation in a specified variable, replace **Save RegEqn To** with the name of the variable.
5. Type **c []** as the column for the **1st Result**.

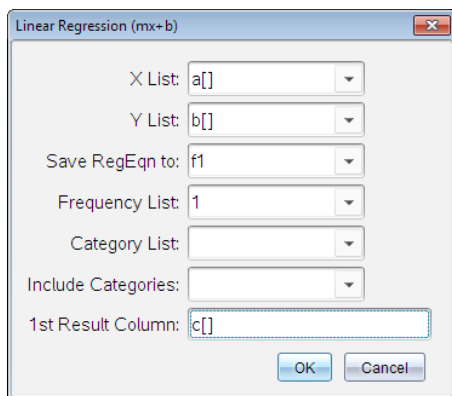

6. Click **OK**.

Lists & Spreadsheet inserts two columns: one containing the names of the results, and one containing the corresponding values.

	A	B	C	D
=				=LinRegMx(a[],b[],1): C
1	1	7	Title	Linear Regression (mx+..
2	2	12	RegEqn	m*x+b
3	3	17	m	5.
4	4	22	b	2.
5	5	27	r <sup>2</sup>	1.
6			r	1.
7			Resid	{0.,0.,0.,0.,0.}
D	=LinRegMx(a[[]],b[[]],1): CopyVar Stat.RegEqn,!f!			

**Note:** The results are linked to the source data. For example, if you change a value in column A, the regression equation is updated automatically.

### Storing Statistical Results

Lists & Spreadsheet stores statistical results using a variable-group name with the format `stat.nnn`, where `nnn` is the result name (for example, `stat.RegEqn` and `stat.Resid`). The use of standard names for variables makes it easier to identify and use the statistical variables later. If you want to use a custom variable group instead of the standard name, you can edit the formula in the column formula cell.

You could use the following formula to store the results in the variable group **MystatsB**.

```
=LinRegMx(a[],b[],1): CopyVar Stat., MystatsB.
```

Later, you could view the results by entering the following expression in the Calculator application or in another column of the Lists & Spreadsheet application:

```
MystatsB.results
```

### Supported Statistical Calculations

The **Stat Calculations** menu lets you select from the calculations described below. For more information, see the *TI-Nspire™ Reference Guide*.

### **One-Variable Statistics (OneVar)**

Analyses data with one measured variable. You can specify an optional frequency list. The statistical data returned using this analysis technique are:

- Sample mean,  $\bar{x}$
- Sum of the data,  $\Sigma x$
- Sum of the squared data,  $\Sigma x^2$
- Sample standard deviation,  $s_x$
- Population standard deviation,  $\sigma_x$
- Sample size,  $n$
- X-min
- First quartile,  $Q_1$
- Median
- Third quartile,  $Q_3$
- X-max
- Sum of squared deviations,  $SS_x = \Sigma(x - \bar{x})^2$

### **Two-Variable Statistics (TwoVar)**

Analyses paired data. *List 1* is the independent variable. *List 2* is the dependent variable. You can specify an optional frequency list. The statistical data returned using this analysis technique are:

For each list:

- Sample mean,  $\bar{x}$  or  $\bar{y}$
- Sum of the data,  $\Sigma x$  or  $\Sigma y$
- Sum of the squared data,  $\Sigma x^2$  or  $\Sigma y^2$
- Sample standard deviation,  $s_x = s_{n-1}x$  or  $s_y = s_{n-1}y$
- Population standard deviation,  $\sigma_x = \sigma_n x$  or  $\sigma_y = \sigma_n y$
- X-min or Y-min
- First quartile,  $Q_1X$  or  $Q_1Y$
- Median
- Third quartile,  $Q_3X$  or  $Q_3Y$

- X-max or Y-max
- Sum of squared deviations,  $SS_x = \sum(x - \bar{x})^2$  or  $SS_y = \sum(y - \bar{y})^2$

Additional data:

- Sample size for each data set,  $n$
- $\sum xy$
- Correlation coefficient,  $R$ .

### ***Linear Regression (mx+b) (LinRegMx)***

Fits the model equation  $y=ax+b$  to the data using a least-squares fit. It displays values for **m** (slope) and **b** (y-intercept).

### ***Linear Regression (a+bx) (LinRegBx)***

Fits the model equation  $y=a+bx$  to the data using a least-squares fit. It displays values for **a** (y-intercept), **b** (slope),  $r^2$ , and  $r$ .

### ***Median-Median Line (MedMed)***

Fits the model equation  $y=mx+b$  to the data using the median-median line (resistant line) technique, calculating the summary points  $x_1, y_1, x_2, y_2, x_3$  and  $y_3$ . **Median-Median Line** displays values for **m** (slope) and **b** (y-intercept).

### ***Quadratic Regression (QuadReg)***

Fits the second-degree polynomial  $y=ax^2+bx+c$  to the data. It displays values for **a**, **b**, **c**, and  $R^2$ . For three data points, the equation is a polynomial fit; for four or more, it is a polynomial regression. At least three data points are required.

### ***Cubic Regression (CubicReg)***

Fits the third-degree polynomial  $y=ax^3+bx^2+cx+d$  to the data. It displays values for **a**, **b**, **c**, **d**, and  $R^2$ . For four points, the equation is a polynomial fit; for five or more, it is a polynomial regression. At least four points are required.

### ***Quartic Regression (QuartReg)***

Fits the fourth-degree polynomial  $y=ax^4+bx^3+cx^2+dx+e$  to the data. It displays values for **a**, **b**, **c**, **d**, **e** and  $R^2$ . For five points, the equation is a polynomial fit; for six or more, it is a polynomial regression. At least five points are required.

### **Power Regression (PowerReg)**

Fits the model equation  $y=ax^b$  to the data using a least-squares fit on transformed values  $\ln(x)$  and  $\ln(y)$ . It displays values for **a**, **b**,  $r^2$  and **r**.

### **Exponential Regression (ExpReg)**

Fits the model equation  $y=ab^x$  to the data using a least-squares fit on transformed values  $x$  and  $\ln(y)$ . It displays values for **a**, **b**,  $r^2$  and **r**.

### **Logarithmic Regression (LogReg)**

Fits the model equation  $y=a+b \ln(x)$  to the data using a least-squares fit on transformed values  $\ln(x)$  and  $y$ . It displays values for **a**, **b**,  $r^2$  and **r**.

### **Sinusoidal Regression (SinReg)**

Fits the model equation  $y=a \sin(bx+c)+d$  to the data using an iterative least-squares fit. It displays values for **a**, **b**, **c** and **d**. At least four data points are required. At least two data points per cycle are required to avoid aliased frequency estimates.

**Note:** The output of **SinReg** is always in radians, regardless of the Radian/Degree mode setting.

### **Logistic Regression (d=0) (Logistic)**

Fits the model equation  $y=c/(1+a*e^{-bx})$  to the data using an iterative least-squares fit. It displays values for **a**, **b** and **c**.

### **Logistic Regression (d≠0) (LogisticD)**

Fits the model equation  $y=c(1+a*e^{-bx})+d$  to the data using an iterative least-squares fit. It displays values for **a**, **b**, **c** and **d**.

### **Multiple Linear Regression (MultReg)**

Calculates multiple linear regression of list Y on lists X1, X2, ..., X10.

## **Distributions**

### **Calculating a Distribution**

Example: Calculate a distribution to fit the Normal Pdf distribution model.

1. Click the column formula cell (second cell from the top) in column A.
2. Click **Statistics > Distributions > Normal Pdf** to choose the Distribution model.



The Normal Pdf dialogue box opens and displays fields for typing or selecting the arguments for the calculation.

3. Press **Tab** as necessary to move from field to field and provide each argument. You can type values, or select them from the drop-down list:
  - **X Value:** Click the drop-down arrow to choose any list in the problem to provide the x values for the calculation.
  - **Mean:** Type a value for the mean or click the drop-down arrow to choose a variable that contains the mean.
  - **Standard Deviation:** Type a value for the standard deviation or choose a variable that contains the standard deviation.
4. Click the **Draw** tick box to see the distribution plotted in Data & Statistics.

**Note:** The Draw option is not available for all distributions.

5. Click **OK**.

Lists & Spreadsheet inserts two columns: one containing the names of the results, and one containing the corresponding values. The results are plotted in Data & Statistics.

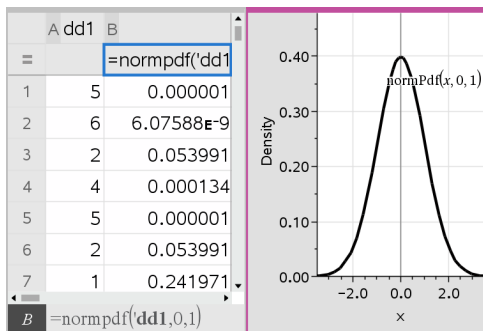

**Note:** The results are linked to the source data. For example, you can change a value in Column A, and the equation updates automatically.

### Supported Distribution Functions

The following distributions are available from the Lists & Spreadsheet application. For more information regarding these functions, see the *TI-Nspire™ Reference Guide*.

- To return a single distribution result based on a single value, type the function in a single cell.

- To return a list of distribution results based on a list of values, type the function in a column formula cell. In this case, you specify a list (column) that contains the values. For each value in the list, the distribution returns a corresponding result.

**Note:** For distribution functions that support the draw option (**normPdf**, **t Pdf**,  **$\chi^2$  Pdf**, and **F Pdf**), the option is available only if you type the distribution function in a formula cell.

### **Normal Pdf (normPdf)**

Computes the probability density function (**Pdf**) for the normal distribution at a specified  $x$  value. The defaults are mean  $\mu=0$  and standard deviation  $\sigma=1$ . The probability density function (Pdf) is:

$$f(x) = \frac{1}{\sqrt{2\pi}\sigma} e^{-\frac{(x-\mu)^2}{2\sigma^2}}, \sigma > 0$$

This distribution is used to determine the probability of the occurrence of a certain value in a normal distribution. The draw option is available when Normal Pdf is invoked from a formula cell.

When you access distributions from the formula cell, you must select a valid list from the drop-down list to avoid unexpected results. If accessed from a cell, you must specify a number for the  $x$ -value. The distribution returns the probability that the value you specify will occur.

### **Normal Cdf (normCdf)**

Computes the normal distribution probability between *Lower Bound* and *Upper Bound* for the specified mean,  $\mu$  (default=0) and the standard deviation,  $\sigma$  (default=1). You can click the **Draw (Shade area)** box to shade the area between the lower and upper bounds. Changes to the initial *Lower Bound* and *Upper Bound* automatically update the distribution.

This distribution is useful in determining the probability of an occurrence of any value between the lower and upper bounds in the normal distribution. It is equivalent to finding the area under the specified normal curve between the bounds.

### **Inverse Normal (invNorm)**

Computes the inverse cumulative normal distribution function for a given *area* under the normal distribution curve specified by mean,  $\mu$  and standard deviation,  $\sigma$ .

This distribution is useful in determining the  $x$ -value of data in the area from 0 to  $x < 1$  when the percentile is known.

### **t Pdf (tPdf)**

Computes the probability density function (**Pdf**) for the *t* distribution at a specified *x* value. *df* (degrees of freedom) must be 0. The probability density function (**Pdf**) is:

$$f(x) = \frac{\Gamma[(df+1)/2]}{\Gamma(df/2)} \frac{(1+x^2/df)^{-(df+1)/2}}{\sqrt{\pi df}}$$

This distribution is useful in determining the probability of the occurrence of a value when the population standard deviation is not known and the sample size is small. The draw option is available when **tPdf** is invoked from a formula cell.

### **t Cdf (tCdf)**

Computes the Student-t distribution probability between *Lower Bound* and *Upper Bound* for the specified *df* (degrees of freedom). You can click the **Draw (Shade area)** box to shade the area between the bounds. Changes to the initial *Lower Bound* and *Upper Bound* automatically update the distribution.

This distribution is useful in determining the probability of the occurrence of a value within an interval defined by the lower and upper bound for a normally distributed population when the population standard deviation is not known.

### **Inverse t (invt)**

Computes the inverse cumulative t-distribution probability function specified by Degrees of Freedom, *df*, for a given area under the curve.

This distribution is useful in determining the probability of an occurrence of data in the area from 0 to  $x < 1$ . This function is used when the population mean and/or population standard deviation is not known.

### **$\chi^2$ Pdf ( $\chi^2$ Pdf())**

Computes the probability density function (**Pdf**) for the  $\chi^2$  (chi-square) distribution at a specified *x* value. *df* (degrees of freedom) must be an integer > 0. The probability density function (**Pdf**) is:

$$f(x) = \frac{1}{\Gamma(df/2)} (1/2)^{df/2} x^{df/2-1} e^{-x/2}, x \geq 0$$

This distribution is useful in determining the probability of the occurrence of a given value from a population with a  $\chi^2$  distribution. The draw option is available when  **$\chi^2$  Pdf** is invoked from a formula cell.

## $\chi^2$ Cdf ( $\chi^2$ Cdf())

Computes the  $\chi^2$  (chi-square) distribution probability between *lowBound* and *upBound* for the specified *df* (degrees of freedom). You can click the **Draw Shade area** box to shade the area between the lower and upper bounds. Changes to the initial *lowBound* and *upBound* automatically update the distribution.

This distribution is useful in determining the probability of the occurrence of value within given boundaries of a population with a  $\chi^2$  distribution.

## F Pdf (F Pdf())

Computes the probability density function (**Pdf**) for the F distribution at a specified *x* value. *numerator df* (degrees of freedom) and *denominator df* must be integers > 0. The probability density function (**Pdf**) is:

$$f(x) = \frac{\Gamma[(n+d)/2]}{\Gamma(n/2)\Gamma(d/2)} \left(\frac{n}{d}\right)^{n/2} x^{n/2-1} (1+nx/d)^{-(n+d)/2}, x \geq 0$$

where  $n$  = numerator degrees of freedom  
 $d$  = denominator degrees of freedom

This distribution is useful in determining the probability that two samples have the same variance. The draw option is available when F Pdf is invoked from a formula cell.

## F Cdf (F Cdf())

Computes the F distribution probability between *lowBound* and *upBound* for the specified *dfNumer* (degrees of freedom) and *dfDenom*. You can click the **Draw (Shade area)** box to shade the area between the lower and upper bounds. Changes to the initial *lowBound* and *upBound* automatically update the distribution.

This distribution is useful in determining the probability that a single observation falls within the range between the lower bound and upper bound.

## Binomial Pdf (binomPdf())

Computes a probability at *x* for the discrete binomial distribution with the specified *numtrials* and probability of success (*p*) on each trial. The *x* parameter can be an integer or a list of integers.  $0 \leq p \leq 1$  must be true. *numtrials* must be an integer > 0. If you do not specify *x*, a list of probabilities from 0 to *numtrials* is returned. The probability density function (**Pdf**) is:

$$f(x) = \binom{n}{x} p^x (1-p)^{n-x}, x = 0, 1, \dots, n$$

where  $n$  = *numtrials*

This distribution is useful in determining the probability of success in a success/failure trial, at trial  $n$ . For example, you could use this distribution to predict the probability of getting heads in a coin toss on the fifth toss.

### ***Binomial Cdf (binomCdf())***

Computes a cumulative probability for the discrete binomial distribution with  $n$  number of trials and probability  $p$  of success on each trial.

This distribution is useful in determining the probability of a success on one trial before all trials are completed. For example, if heads is a successful coin toss and you plan to toss the coin 10 times, this distribution would predict the chance of obtaining heads at least once in the 10 tosses.

### ***Inverse Binomial (invBinom())***

Given the number of trials (*NumTrials*) and the probability of success of each trial (*Prob*), this function returns the minimum number of successes,  $k$ , such that the cumulative probability of  $k$  successes is greater than or equal to the given cumulative probability (*CumulativeProb*).

### ***Inverse Binomial with respect to N (invBinomN())***

Given the probability of success of each trial (*Prob*), and the number of successes (*NumSuccess*), this function returns the minimum number of trials,  $N$ , such that the cumulative probability of  $x$  successes is less than or equal to the given cumulative probability (*CumulativeProb*).

### ***Poisson Pdf (poissPdf())***

Computes a probability at  $x$  for the discrete Poisson distribution with the specified mean,  $\mu$ , which must be a real number  $> 0$ .  $x$  can be an integer or a list of integers. The probability density function (**Pdf**) is:

$$f(x) = e^{-\mu} \mu^x / x!, x = 0, 1, 2, \dots$$

This distribution is useful in determining the probability of obtaining a certain number of successes before a trial begins. For example, you could use this calculation to predict the number of heads that would occur in eight tosses of a coin.

### ***Poisson Cdf (poissCdf())***

Computes a cumulative probability for the discrete Poisson distribution with specified mean,  $\bar{x}$ .

This distribution is useful in determining the probability that a certain number of successes occur between the upper and lower bounds of a trial. For example, you could use this calculation to predict the number of heads displayed between coin toss No.3 and toss No.8.

### **Geometric Pdf (*geomPdf()*)**

Computes a probability at  $x$ , the number of the trial on which the first success occurs, for the discrete geometric distribution with the specified probability of success  $p$ .  $0 \leq p \leq 1$  must be true.  $x$  can be an integer or a list of integers. The probability density function (Pdf) is:

$$f(x) = p(1-p)^{x-1}, x = 1, 2, \dots$$

This distribution is useful in determining the likeliest number of trials before a success is obtained. For example, you could use this calculation to predict the number of coin tosses that would be made before a heads resulted.

### **Geometric Cdf (*geomCdf()*)**

Computes a cumulative geometric probability from lowBound to upBound with the specified probability of success,  $p$ .

This distribution is useful in determining the probability associated with the first success occurring during trials 1 through  $n$ . For example, you could use this calculation to determine the probability that heads display on toss No.1, No.2, No.3, ..., No. $n$ .

## **Confidence Intervals**

### **Supported Confidence Intervals**

The following confidence intervals are available from the Lists & Spreadsheets application. For more information regarding these functions, see the *TI-Nspire™ Reference Guide*.

#### ***z* Interval (*zInterval*)**

Computes a confidence interval for an unknown population mean,  $\mu$ , when the population standard deviation,  $\sigma$ , is known. The computed confidence interval depends on the user-specified confidence level.

This test is useful in determining how far from a population mean a sample mean can get before indicating a significant deviation.

#### ***t* Interval (*tInterval*)**

Computes a confidence interval for an unknown population mean,  $\mu$ , when the population standard deviation,  $\sigma$ , is unknown. The computed confidence interval depends on the user-specified confidence level.

This test is useful in examining whether the confidence interval associated with a confidence level contains the value assumed in the hypothesis. Like the z Interval, this test helps you determine how far from a population mean a sample mean can get before indicating a significant deviation when the population mean is unknown.

### **2-Sample z Interval (zInterval\_2Samp)**

Computes a confidence interval for the difference between two population means ( $\mu_1 - \mu_2$ ) when both population standard deviations ( $\sigma_1$  and  $\sigma_2$ ) are known. The computed confidence interval depends on the user-specified confidence level.

This test is useful in determining if there is statistical significance between the means of two samples from the same population. For example, this test could determine whether there is significance between the mean college entrance test score of female students and the mean of college entrance test score of male students at the same school.

### **2-Sample t Interval (tInterval\_2Samp)**

Computes a confidence interval for the difference between two population means ( $\mu_1 - \mu_2$ ) when both population standard deviations ( $\sigma_1$  and  $\sigma_2$ ) are unknown. The computed confidence interval depends on the user-specified confidence level.

This test is useful in determining if there is statistical significance between the means of two samples from the same population. It is used instead of the 2-sample z confidence interval in situations where the population is too large to measure to determine the standard deviation.

### **1-Prop z Interval (zInterval\_1Prop)**

Computes a confidence interval for an unknown proportion of successes. It takes as input the count of successes in the sample  $x$  and the count of observations in the sample  $n$ . The computed confidence interval depends on the user-specified confidence level.

This test is useful in determining the probability of a given number of successes that can be expected for a given number of trials. For instance, casino examiners would use this test to determine if observed payouts for one slot machine demonstrate a consistent pay out rate.

### **2-Prop z Interval (zInterval\_2Prop)**

Computes a confidence interval for the difference between the proportion of successes in two populations ( $p_1 - p_2$ ). It takes as input the count of successes in each sample ( $x_1$  and  $x_2$ ) and the count of observations in each sample ( $n_1$  and  $n_2$ ). The computed confidence interval depends on the user-specified confidence level.

This test is useful in determining if two rates of success differ because of something other than sampling error and standard deviation. For example, a gambler could use this test to determine if there is an advantage in the long run by playing one game or machine versus playing another game or machine.

### **Linear Reg t Intervals (LinRegIntervals)**

Computes a linear regression t confidence interval for the slope coefficient  $b$ . If the confidence interval contains 0, this is insufficient evidence to indicate that the data exhibits a linear relationship.

### **Multiple Reg Intervals (MultRegIntervals)**

Computes multiple regression prediction confidence interval for the calculated  $y$  and a confidence for  $y$ .

## **Stat Tests**

### **Supported Statistical Tests**

Hypothesis tests are available from the Lists & Spreadsheets application. For more information regarding these functions, see the *TI-Nspire™ Reference Guide*.

Some of the wizards for Stat Tests display a **Draw** box. By default, the box is not selected. Selecting the box creates a Data & Statistics work area on the page and plots the results in that work area.

### **z test (zTest)**

Performs a hypothesis test for a single unknown population mean,  $\mu$ , when the population standard deviation,  $\sigma$ , is known. It tests the null hypothesis  $H_0: \mu = \mu_0$  against one of the alternatives below.

- $H_a: \mu \neq \mu_0$
- $H_a: \mu < \mu_0$
- $H_a: \mu > \mu_0$

This test is used for large populations that are normally distributed. The standard deviation must be known.

This test is useful in determining if the difference between a sample mean and a population mean is statistically significant when you know the true deviation for a population.

### **t test (tTest)**

Performs a hypothesis test for a single unknown population mean,  $\mu$ , when the population standard deviation,  $\sigma$ , is unknown. It tests the null hypothesis  $H_0: \mu = \mu_0$  against one of the alternatives below.

- $H_a: \mu \neq \mu_0$
- $H_a: \mu < \mu_0$
- $H_a: \mu > \mu_0$



This test is similar to a z-test, but is used when the population is small and normally distributed. This test is used more frequently than the z-test because small sample populations are more frequently encountered in statistics than are large populations.

This test is useful in determining if two normally distributed populations have equal means, or when you need to determine if a sample mean differs from a population mean significantly and the population standard deviation is unknown.

### **2-Sample z Test (zTest\_2Samp)**

Tests the equality of the means of two populations ( $\mu_1$  and  $\mu_2$ ) based on independent samples when both population standard deviations ( $\sigma_1$  and  $\sigma_2$ ) are known. The null hypothesis  $H_0: \mu_1 = \mu_2$  is tested against one of the alternatives below.

- $H_a: \mu_1 \neq \mu_2$
- $H_a: \mu_1 < \mu_2$
- $H_a: \mu_1 > \mu_2$

### **2-Sample t Test (tTest\_2Samp)**

Tests the equality of the means of two populations ( $\mu_1$  and  $\mu_2$ ) based on independent samples when neither population standard deviation ( $\sigma_1$  or  $\sigma_2$ ) is known. The null hypothesis  $H_0: \mu_1 = \mu_2$  is tested against one of the alternatives below.

- $H_a: \mu_1 \neq \mu_2$
- $H_a: \mu_1 < \mu_2$
- $H_a: \mu_1 > \mu_2$

### **1-Prop z Test (zTest\_1Prop)**

Computes a test for an unknown proportion of successes (prop). It takes as input the count of successes in the sample  $x$  and the count of observations in the sample  $n$ . **1-Prop z Test** tests the null hypothesis  $H_0: \text{prop} = p_0$  against one of the alternatives below.

- $H_a: \text{prop} \neq p_0$
- $H_a: \text{prop} < p_0$
- $H_a: \text{prop} > p_0$

This test is useful in determining if the probability of the success seen in a sample is significantly different from the probability of the population or if it is due to sampling error, deviation or other factors.

### **2-Prop z Test (zTest\_2Prop)**

Computes a test to compare the proportion of successes ( $p_1$  and  $p_2$ ) from two populations. It takes as input the count of successes in each sample ( $x_1$  and  $x_2$ ) and the count of observations in each sample ( $n_1$  and  $n_2$ ). **2-Prop z Test** tests the null hypothesis

$H_0: p_1=p_2$  (using the pooled sample proportion  $\hat{p}$ ) against one of the alternatives below.

- $H_a: p_1 \neq p_2$
- $H_a: p_1 < p_2$
- $H_a: p_1 > p_2$

This test is useful in determining if the probability of success seen in two samples is equal.

### $\chi^2$ GOF ( $\chi^2$ GOF)

Performs a test to confirm that sample data is from a population that conforms to a specified distribution. For example,  $\chi^2$  GOF can confirm that the sample data came from a normal distribution.

### $\chi^2$ 2-way Test ( $\chi^2$ 2way)

Computes a chi-square test for association on the two-way table of counts in the specified *Observed* matrix. The null hypothesis  $H_0$  for a two-way table is: no association exists between row variables and column variables. The alternative hypothesis is: the variables are related.

### 2-Sample F Test (F Test\_2Samp)

Computes an F-test to compare two normal population standard deviations ( $\sigma_1$  and  $\sigma_2$ ). The population means and standard deviations are all unknown. **2-Sample F Test**, which uses the ratio of sample variances  $Sx1^2/Sx2^2$ , tests the null hypothesis  $H_0: \sigma_1=\sigma_2$  against one of the alternatives below.

- $H_a: \sigma_1 \neq \sigma_2$
- $H_a: \sigma_1 < \sigma_2$
- $H_a: \sigma_1 > \sigma_2$

Below is the definition for the **2-Sample F Test**.

$Sx1, Sx2$  = Sample standard deviations having  $n_1-1$  and  $n_2-1$  degrees of freedom *df*, respectively.

$F$  = F-statistic =  $\left(\frac{Sx1}{Sx2}\right)^2$

$df(x, n_1-1, n_2-1)$  =  $Fpdf()$  with degrees of freedom *df*,  $n_1-1$ , and  $n_2-1$

$p$  = reported *p* value

**2-Sample F Test** for the alternative hypothesis  $\sigma_1 > \sigma_2$ .

$$p = \int_F^{\alpha} f(x, n_1 - 1, n_2 - 1) dx$$

**2-Sample F Test** for the alternative hypothesis  $\sigma_1 < \sigma_2$ .

$$p = \int_0^F f(x, n_1 - 1, n_2 - 1) dx$$

**2-Sample F Test** for the alternative hypothesis  $\sigma_1 \neq \sigma_2$ . Limits must satisfy the following:

$$\frac{L}{2} = \int_0^{L_{bnd}} f(x, n_1 - 1, n_2 - 1) dx = \int_{U_{bnd}}^{\infty} f(x, n_1 - 1, n_2 - 1) dx$$

where:  $[L_{bnd}, U_{bnd}]$  = lower and upper limits

The F-statistic is used as the bound producing the smallest integral. The remaining bound is selected to achieve the preceding integral's equality relationship.

### **Linear Reg t Test (LinRegtTest)**

Computes a linear regression on the given data and a  $t$  test on the value of slope  $\beta$  and the correlation coefficient  $\rho$  for the equation  $y = \alpha + \beta x$ . It tests the null hypothesis  $H_0: \beta = 0$  (equivalently,  $\rho = 0$ ) against one of the alternatives below.

- $H_a: \beta \neq 0$  and  $\rho \neq 0$
- $H_a: \beta < 0$  and  $\rho < 0$
- $H_a: \beta > 0$  and  $\rho > 0$

### **Multiple Reg Tests (MultRegTest)**

Computes a linear regression on the given data, and provides the F test statistic for linearity.

For more information, see the *TI-Nspire™ Reference Guide*.

### **ANOVA (ANOVA)**

Computes a one-way analysis of variance for comparing the means of 2 to 20 populations. The ANOVA procedure for comparing these means involves analysis of the variation in the sample data. The null hypothesis  $H_0: \mu_1 = \mu_2 = \dots = \mu_k$  is tested against the alternative  $H_a$ : not all  $\mu_1 \dots \mu_k$  are equal.

The ANOVA test is a method of determining if there is a significant difference between the groups as compared to the difference occurring within each group.

This test is useful in determining if the variation of data from sample-to-sample shows a statistically significant influence of some factor other than the variation within the data sets themselves. For example, a box buyer for a shipping firm wants to evaluate three different box manufacturers. He obtains sample boxes from all three suppliers.

ANOVA can help him determine if the differences between each sample group are significant as compared to the differences within each sample group.

### ***ANOVA 2-Way (ANOVA2way)***

Computes a two-way analysis of variance for comparing the means of two to 20 populations. A summary of results is stored in the *stat.results* variable.

The two-way ANOVA analysis of variance examines the effects of two independent variables and helps to determine if these interact with respect to the dependent variable. (In other words, if the two independent variables do interact, their combined effect can be greater than or less than the impact of either independent variable additively.)

This test is useful in evaluating differences similar to the ANOVA analysis but with the addition of another potential influence. To continue with the ANOVA box example, the two-way ANOVA might examine the influence of box material on the differences seen.

### ***Selecting an Alternative Hypothesis ( $\neq < >$ )***

Most of the inferential stat editors for the hypothesis tests prompt you to select one of three alternative hypotheses.

- The first is a  $\neq$  alternative hypothesis, such as  $\mu \neq \mu_0$  for the **z Test**.
- The second is a  $<$  alternative hypothesis, such as  $\mu_1 < \mu_2$  for the **2-Sample t Test**.
- The third is a  $>$  alternative hypothesis, such as  $p_1 > p_2$  for the **2-Prop z Test**.

To select an alternative hypothesis, move the cursor to the appropriate alternative, and then press **Enter**.

### ***Selecting the Pooled Option***

**Pooled (2-Sample t Test and 2-Sample t Interval only)** specifies whether the variances are to be pooled for the calculation.

- Select **No** if you do not want the variances pooled. Population variances can be unequal.
- Select **Yes** if you want the variances pooled. Population variances are assumed to be equal.

To select the **Pooled** option, select Yes from the drop-down list.

### ***Working with Function Tables***

The Lists & Spreadsheet application lets you show a table of function values for any function in the current problem. You can change the settings for the table, delete columns, add values for multiple functions, and edit the expression that defines a function without leaving the Lists & Spreadsheet application.

### ***Switching to a Table***

1. While working in the Lists & Spreadsheet application:

Windows®: Press **Ctrl+T**.

Mac®: Press **⌘+T**.

Handheld: Press **ctrl T**.

The Lists & Spreadsheet application disappears and an empty table is displayed with a list of the functions that are available in the problem.

**Note:** If you have previously shown a table for a function from the Lists & Spreadsheet application, the table includes that function by default.

2. Choose the name of the function for which you want to display values.

Values for the function you selected are displayed in the first column of the table.

3. To move through adjacent cells of the table, press **▲** or **▼**. Press **Tab** to move from the body of the table (cells) to the top two rows (cells for column names and formulas).
4. To hide the table of values and return to the Lists & Spreadsheet application, repeat Step 1.

### **Making Changes from a Table**

You can change the table of function values using the tools on the **Table** menu.

- ▶ To remove a column from the table, click any cell and click **Delete Column**.
- ▶ To display the list of functions, click a cell in a column and click **Choose**. Select a cell in an empty column unless you are replacing values already displayed. Click a function in the list to add its values to the column.

**Note:** You can also click the drop-down arrow on the top cell of a column to display the list of functions in the problem.

- ▶ To change the expression that defines a function, click **Edit Expression**. You can also edit the expression directly on the entry line beneath the table.

**Note:** When you edit the expression for a function, that function automatically changes in the application used to define the function. For example, if you edit a Graphs & Geometry function in the table, the table values and graph of the function are both updated.

- ▶ To change the default table settings, choose **Edit Table Settings**.

The Table dialogue box opens. Press **Tab** to move from field to field and type or select new values for the default table settings:

- **Table Start:** Type the value to use as the first value in the table of values.
- **Table Step:** Type a value for the interval between values.
- **Independent and Dependent:** Click the drop-down arrow to choose **Auto** or **Ask** as the method for populating a column with the values of the independent and dependent variables. **Auto** populates the table starting at the defined table start value and displays an independent and dependent value for each step. **Ask** lets you select a cell and press **Enter** to generate a value for a cell.

# Data & Statistics Application

The Data & Statistics application provides tools to:

- Visualise sets of data in different types of plots.
- Directly manipulate variables to explore and visualise data relationships. Data changes in one application are dynamically applied to all linked applications.
- Explore central tendency and other statistical summary techniques.
- Fit functions to data.
- Create regression lines for scatter plots.
- Graph hypothesis tests and results (z- and t-tests) based on summary statistics definitions or data.

## Adding a Data & Statistics Page

- ▶ To start a new document with a blank Data & Statistics page:

From the main **File** menu, click **New Document**, and then click **Add Data & Statistics**.

Handheld: Press **[fn] on**, and select **Data & Statistics** **[lin]**.

- ▶ To add a Data & Statistics page in the current problem of an existing document:

From the toolbar, click **Insert > Data & Statistics**.

Handheld: Press **[doc.v]** and select **Insert > Data & Statistics**.

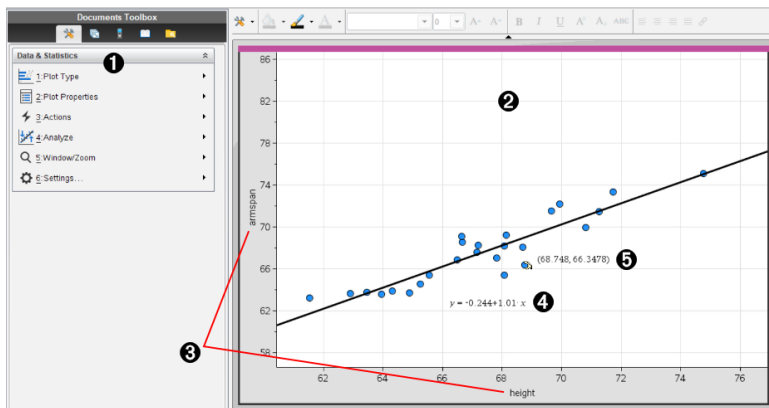

- 1 Data & Statistics menu
- 2 Work area
- 3 Add Variable regions on x-axis and y-axis

- ④ Linear Regression Plot with expression
- ⑤ Data point with coordinates

## Basic Operations in Data & Statistics

The Data & Statistics application lets you explore and visualise data and graph inferential statistics. The Lists & Spreadsheet application can work in conjunction with the Data & Statistics application. The Lists & Spreadsheet Summary Plot and Quick Graph tools automatically add a Data & Statistics application to show plots. A list that you create in a problem (using the Lists & Spreadsheet or Calculator applications) can be accessed as a variable in any TI-Nspire™ application in that problem.

### Changing Data & Statistics Settings

1. From the **Settings** menu, select **Settings**.
2. Select the settings that you want to use.
  - **Display Digits.** Lets you select the display format for numeric labels in the current document. Select **Auto** to automatically follow the setting in the Document Settings dialogue box.
  - **Diagnostics.** Displays the value of the  $r^2$  or  $R^2$  statistic (when available) under certain regression equations.
    - $r^2$  is displayed for Linear ( $mx+b$ ), Linear ( $a+bx$ ), Power, Exponential and Logarithmic regressions.
    - $R^2$  is displayed for Quadratic, Cubic and Quartic regressions.

### Using the Default Caseplot

The Data & Statistics application plots numeric and string (categorical) data from variables. When you add a Data & Statistics application to a problem that includes lists, a default caseplot displays on the work area.

The caseplot is like having a stack of cards with information on them and scattering the cards randomly on a table. You can click a dot to see the information on that “card”. You can drag a dot to “group” the “cards” by the caption variable.



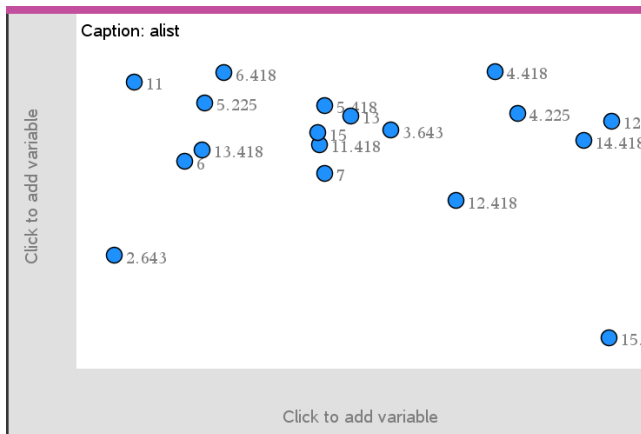

- ▶ Click the variable name displayed after **Caption** to use the caseplot.
  - Choose <None> to remove the default caseplot.
  - Choose the name of a variable to have it replace the current caseplot variable.
  - Hover over any data point to see the summary information.
  - Drag any data point toward an axis to see how the points group.
  - Activate the Graph Trace tool and press ◀ or ▶ to move across points.

When you add a variable to either axis, the plot for that variable replaces the default caseplot. The default caseplot redisplay if you remove the plotted variable from each axis.

### Using the Context Menu

The context menu provides access to the tools most commonly used with the selected object. The context menu displays different options depending on the active object and the task you are performing.

- ▶ To open the context menu for an object.

Windows®: Right-click the object.

Mac®: Hold  $\mathcal{C}$  and click the object.

Handheld: Point to the object and press  .

The context menu includes the **Colour** option. You can use the Colour option to change the data to the colour of your choice.

Other options that are appropriate for various plots also appear on the context menu.

## Selecting Data and Displaying Summary Information

When you hover over part of a plot, the Data & Statistics application displays summary information for the data it represents.

1. Hover at an area of interest in a plot to display data values or summary information. For example, you can hover over the centre of a box plot to display the median summary data.
2. Click once to select a representation of data in a plot.

Data points are shown with a bold outline to indicate selection. You can click a point a second time to deselect it, or click additional points to add to the selection.

## Plotting Variables

To plot variables, start with a problem that includes a Data & Statistics application and lists created in the Lists & Spreadsheet application or the Calculator application.

1. Click the Add Variable region near the centre of an axis.

If no variable is plotted on the axis, the tooltip **Click or Enter to add variable** displays.

2. Click the tooltip **Click or Enter to add variable**.

A list displays the names of available variables.

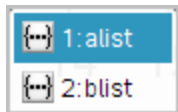

3. Click the name of the variable to plot.

**Note:** By convention, the independent variable is shown on the x-axis.

The default plot for one variable is a dot chart. The data points in the default caseplot reposition to represent the elements of the selected variable in a dot chart.

4. (Optional) Click the Add Variable region near the centre of the remaining axis to plot a second variable.

The default plot for two variables is a scatter plot. The data points shift to represent the elements of both variables as a scatter plot.

- (Optional) Repeat Steps 1-3 to choose additional variables to plot on the vertical axis.

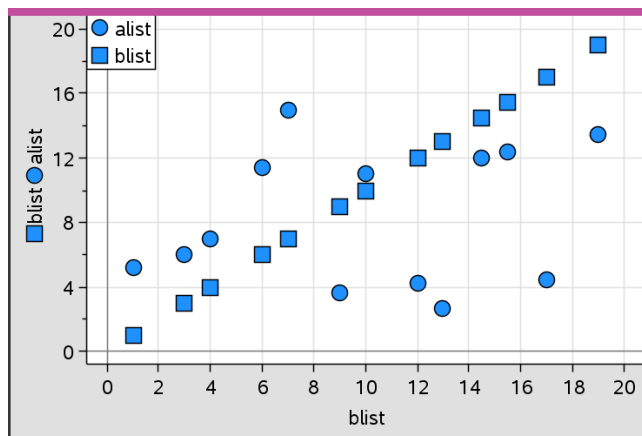

The name of each variable that you add is appended to the label on the axis. The default data point shape changes to help you distinguish data, and a legend is displayed to identify the shapes.

- Change, analyse or explore the plotted data.
  - Remove or change the variable on an axis by clicking the Add Variable region again.
  - View the plotted data in another supported plot type by selecting a tool from the **Plot Types** menu.
  - Choose the Graph Trace tool on the **Analyse** menu and press ◀ or ▶ to move across the data points in the plot.
  - The lists that you plot as variables can include incomplete or missing cases. (A case is the data contained in a row of cells in the Lists & Spreadsheet application.) The Lists & Spreadsheet application displays a void as an underscore ("\_"), and Data & Statistics plots no data point for a void cell.

### Manipulating Plotted Data

You can manipulate data points on the Data & Statistics work area to explore their effects. For example, you could explore how a specific group of values affects the median.

You can move a data point only in directions allowed by its definition. If a list is defined with a formula in Lists & Spreadsheet, the points in Data & Statistics may not move because of the formula's restrictions. For example, you can manipulate a plot that represents the result of  $y=x$ , but you can only move along a line.

You cannot move points that represent data in a locked variable or data that represents a categorical value.

1. On the Data & Statistics work area, click a representation of data—such as a histogram bin or a whisker of a box plot—that is not locked or restricted by a formula.

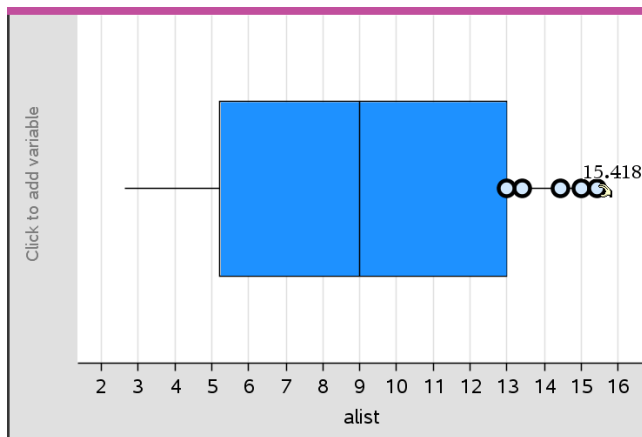

The pointer changes to an open hand to show that the data can be moved.

2. Drag the selection to explore how different values of the point affect the plot.

Handheld: Press **ctrl**  to grab, and then swipe or use the arrow keys to drag.

As you drag, the changing value displays on the work area.

## ***Overview of Raw and Summary Data***

You can create plots directly from raw data or from a summary table.

	A person	B ht	C wt	D eyecolor	E gender	F
1	1	56	130	blue	f	
2	2	55	150	blue	m	
3	3	60	200	green	f	
4	4	62	270	brown	m	
5	5	65	250	brown	f	
6	6	71	187	green	m	
7	7	62	176	brown	m	

Raw data

	A color	B counts	C	D	E
1	blue	3			
2	green	3			
3	brown	4			
4					
5					
6					
7					

Summary table for eye colour based on raw data

- Raw data consists of a single list, such as a list of eye colours. When you create a plot of raw data, Data & Statistics counts the occurrences for you. Plotting raw data directly gives you flexibility in analysing it.
- A summary table consists of two lists, such as eye colours (the X or Y List) and counts of eye-colour occurrences (the Summary List). For more information, see *Using Lists & Spreadsheet* chapter.

## Working with Numeric Plot Types

Plots can represent the data from a variable in a variety of ways. Choosing the appropriate plot can help you visualise the data. For example, you may be able to observe the shape and spread of the data in one plot type and another type may be useful for determining the best method for statistically evaluating data.

### Creating Dot Plots

Dot plots, also known as dot-frequency plots, represent one-variable data. Dot plots are the default plot type for numeric data. When you plot a variable as a dot plot, one dot represents each value in the list. Each dot displays on the axis at a point that correspond to the value.

1. To create a dot plot, click the Add Variable region in the center of an axis and click the name of a numeric variable. For more information, see *Plotting Variables*.
2. (Optional) To split a dot plot by category, click the Add Variable region on the other axis and choose the list that contains the corresponding category data.
3. (Optional) To plot multiple dot plots, choose **Add X Variable** on the **Plot Properties** menu and click a numeric variable from the list that displays.

A second dot plot appears on the work area and the name of the plotted variable is added to both axis labels.

4. Explore the plotted data.
  - Hover over a data point to display data values.

- Drag a dot to move it. As you move a point, the values associated with it change on the work area display and in the list for the variable.
- Activate the Graph Trace tool and press ◀ or ▶ to move across the data points in the plot in list order. Points enlarge and display a bold outline as you move across them in Trace mode.

### Creating Box Plots

The Box Plot Tool plots one-variable data in a modified box plot. “Whiskers” extend from each end of the box, either to 1.5 times the interquartile range or to the end of the data, whichever comes first. Points that are a width of  $1.5 * \text{Interquartile Range}$  past the quartiles plot individually, beyond the whiskers. These points are the potential outliers. When no outliers exist, x-min and x-max are the prompt for the end of each whisker.

Box plots are useful for comparing two or more sets of data that use the same scale. If a dataset is large, a box plot can also be useful in exploring data distribution.

1. Click the Add Variable region in the centre of an axis. The default plot for one numeric variable is a dot plot. For more information, see *Plotting Variables*.

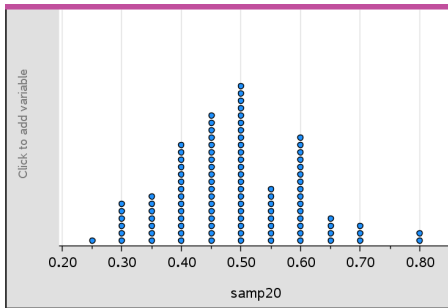

**Note:** If two variables are plotted in the work area, you can create a dot plot by removing one variable. Choose **Remove X Variable** or **Remove Y Variable** from the **Plot Types** menu.

2. On the **Plot Types** menu, click **Box Plot**.

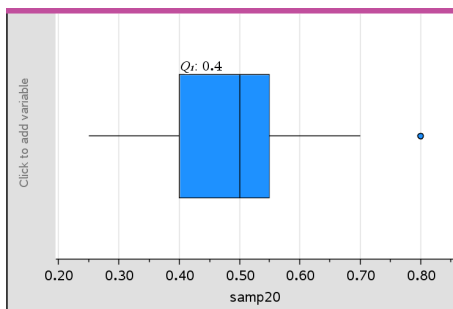

A modified box plot displays on the Data & Statistics work area.

**Note:** You can split a box plot by category by adding a list that contains corresponding categorical data to the y-axis.

- (Optional) To add additional variables for comparing box plots on the same axis, click **Add X Variable** on the **Plot Properties** menu.

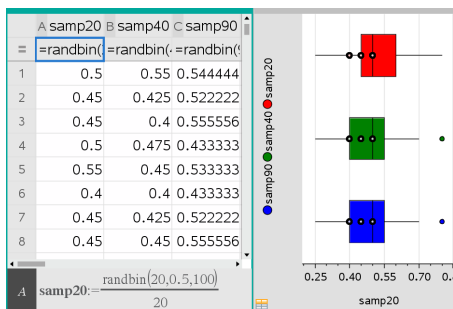

For example, you can use multiple box plots to compare the distributions of sample proportions. In the example, true proportion is .5 and sample size varies from  $n=20$  to  $n=40$  to  $n=90$ .

**Notes:**

- You can create a box plot with frequency by choosing **Add X Variable** or **Add Y Variable** on the **Plot Properties** menu.
- You can specify a variable multiple times as you choose variables to plot as box plots.
- The variable used to provide frequency information is added to the label on the horizontal axis in the format:  $x\_variablename\{frequencylist\_name\}$ .

4. Point and click the regions of the box plot to explore and analyse the data it represents.
  - Hover over a region or over a whisker to display the details for the portion of the plot that interests you. The label for the quartile that corresponds to your selection is displayed.
  - Click a region of the box plot to select the data points or whiskers. Click again to remove the selection.
  - You can select any box plot that does not include frequency data and choose **Dot Plot** on the context menu to change the plot type.
  - Drag a selection to move it and explore other possibilities for the data.
  - Use the arrow keys to move a data point one pixel at a time.
  - Activate the Graph Trace tool and press ◀ or ▶ to move across dots and regions of the plot. As the trace cursor moves, the values for Q1, the median, Q3 and whisker ends/outliers are displayed.
5. Change the plot from a modified box plot to a standard box plot by choosing **Extend Box Plot Whiskers** on the **Plot Properties** menu.

The box plot is redrawn as a standard box plot with extended whiskers.

The standard box plot's whiskers use the minimum and maximum points in the variable and outliers are not identified. The whiskers on the plot extend from the minimum data point in the set ( $x$ -min) to the first quartile (Q1) and from the third quartile (Q3) to the maximum point ( $x$ -max). The box is defined by Q1, Med (median), and Q3.

**Note:** You can click **Show Box Plot Outliers** on the **Plot Properties** menu to return to the modified box plot.

## Plotting Histograms

A histogram plots one-variable data and depicts the distribution of data. The number of bins displayed depends on the number of data points and the distribution of these points. A value that occurs on the edge of a bin is counted in the bin to the right.

### *Creating a Histogram from Raw Data*

1. Create the list that you want to plot as a histogram. For example, you can enter or collect data as a named list on a Lists & Spreadsheet page.



	A	ht	B	C	D	E
=						
1		40				
2		40				
3		45				
4		45				
5		45				
6		45				
7		55				

- On a Data & Statistics page, click the x or y axis, and select your list as the data to plot.
- From the **Plot Types** menu, click **Histogram**.

The data forms the bins of a histogram, with Frequency plotted by default on the unselected axis.

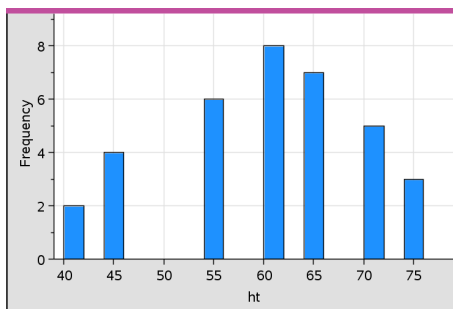

- Explore the data.
  - Hover over a bin to see the information for that bin.
  - Click a bin to select it. Click the bin again to deselect it.
  - Drag the side of a bin to adjust bin width and number of bins.

**Note:** The bins are not adjustable in categorical plots or plots in which you choose variable bin widths.

- On the **Analyse** menu, click **Graph Trace** and press ◀ or ▶ to cycle through the bins and display their values.

### **Adjusting the Histogram Scale of Raw Data**

1. On the **Plot Properties** menu, click **Histogram Properties** and choose **Histogram Scale**.
2. Choose the format for the scale of the histogram.
  - **Frequency** - displays data based upon the number of values that occur within each bin. This is the default data representation.
  - **Percent** - displays data in the histogram by each group's percent value of the whole data set.
  - **Density** - displays data based upon the density of each group within the data set.

### **Creating a Histogram with Frequency or Summary Data**

1. On a Lists & Spreadsheet page, create two lists: one containing the "bins", such as heights in a population (*ht*), and the other containing the frequencies of those heights (*freq*).

The screenshot shows a TI-84 Plus calculator's Lists & Spreadsheet page. The screen displays a table with two columns: 'ht' (height) and 'freq' (frequency). The data is as follows:

	A ht	B freq	C	D	E	F
1	40	2				
2	45	4				
3	50	0				
4	55	6				
5	60	8				
6	65	7				
7	70	5				
8	75	3				

The calculator's status bar at the bottom shows 'A1 40'.

2. On a Data & Statistics page, access the context menu on the x axis, and click **Add X Variable with Summary List**.
3. Select *ht* as the X List and *freq* as the Summary List.

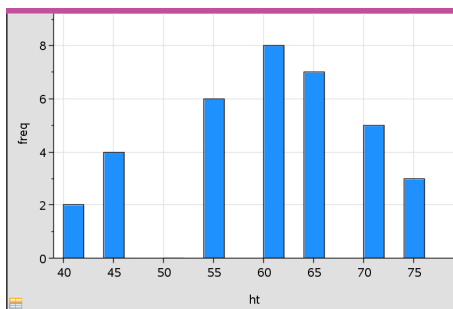

**Note:** It is up to you to set the data and bins in a meaningful way when using summary data.

### Setting Equal Bin Widths

By default, bin widths are set to equal. You can specify the width and alignment of equal-width bins.

1. On the **Plot Properties** menu, click **Histogram Properties > Bin Settings** and choose **Equal Bin Width**.

The **Equal Bin Width Settings** dialog box opens.

2. Type values to set **Width** and **Alignment** of the bins.
3. Click **OK** to apply the changes and redraw the bins.

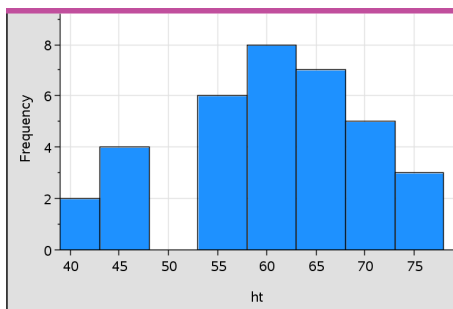

Both the data represented by the bins and the value you type for the alignment affect the placement of bins on the scale.

### Setting Variable Bin Widths

You can set variable bin widths based on a list of bin boundaries.

1. Create a named list containing boundary values.

For example, a boundary list defined as {60,70,100,110} will create bins at 60 to 70, 70 to 100 and 100 to 110.

**Note:** The data must fall within the specified bin widths. For example, a data point of 115 would be outside the bins in the above list, and you would receive a Data/Bin Location Mismatch error.

2. On the **Plot Properties** menu, click **Histogram Properties > Bin Settings** and choose **Variable Bin Width**.

The **Variable Bin Width Settings** dialogue box opens.

3. Select your boundary list as the **List of Bin Boundaries**.
4. Click **OK** to apply the changes and redraw the bins.

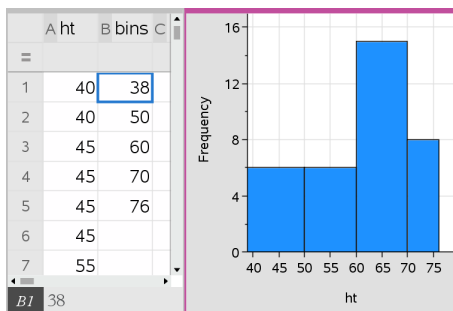

**Note:** You cannot change variable bin widths by dragging their boundaries; you must edit the list of boundaries or restore equal-width bins.

### Creating a Normal Probability Plot

A normal probability plot shows one set of data against the corresponding quartile ( $z$ ) of the standard normal distribution. You can use normal probability plots to judge the appropriateness of the normal model for your data.

1. Choose or create the data you want to use for a normal probability plot. Use a named list from Lists & Spreadsheet or Calculator.
2. Plot the data in one of the following ways:
  - Create a dot plot by selecting a column and choosing **Quick Graph**.
  - Add a Data & Statistics work area. Click the Add Variable region on an axis and click the data list name to plot the variable.
3. On the **Plot Types** menu, click **Normal Probability Plot**.

The data graphs in the Data & Statistics work area. You can examine the graph to compare the normal variable against the quartile.

4. Explore the data represented in the normal probability plot.
  - Hover over a data point to display its value.
  - Click to select a data point. Click again to deselect it.
  - Click multiple data points to select them.
  - Activate the Graph Trace tool and press ◀ or ▶ to move across the data points and display values.

### Creating a Scatter Plot

A scatter plot shows the relationship between two sets of data. You can also plot a scatter plot by using the Quick Graph tool in the Lists & Spreadsheet application.

1. In the Data & Statistics work area, click the Add Variable region and select the variable that contains the data you want to see represented on an axis.

The plot of the selected variable displays on the axis.

2. Click the Add Variable region of the other axis and select the variable containing the data you want to plot.

The data points shift to represent the data in the selected variable.

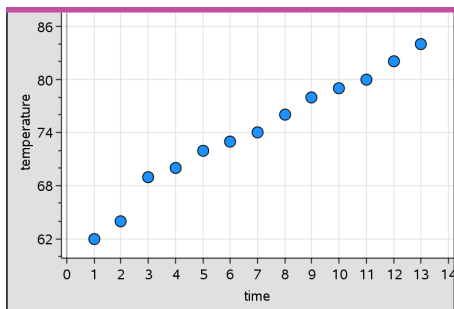

3. Analyse and explore the data in the plot.
  - Click a point to select it.
  - Hover over a data point to view the summary data.
  - Work with the data using the available tools on the **Analyse** menu. For example, choose the Graph Trace tool and press ◀ or ▶ to move across the plot.

- Optional: To plot additional lists against the x-axis, right-click the y-axis and click **Add Variable**.

### Creating an X-Y Line Plot

An X-Y line plot is a scatter plot in which the data points are plotted and connected in order of appearance in the two variables. Like scatter plots, these plots depict the relationship between two sets of data.

By convention, the left-most column of data is represented on the horizontal axis.

- Create a scatter plot. For more information, see *Creating a Scatter Plot*.
- On the **Plot Types** menu, click the **XY Line Plot** tool.

The data points within each set are connected to each other by a line.

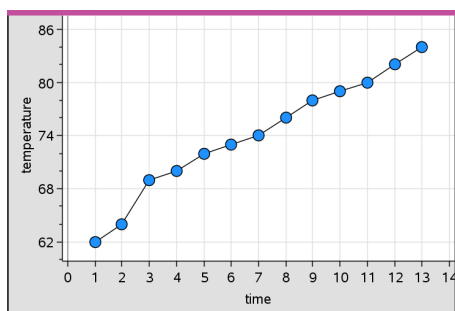

**Note:** The dots are connected in the order that they appear in the list variable on the horizontal axis. To change the order, use the sort tool in Lists & Spreadsheet.

- Analyse and explore the data in the plot.
  - Hover over a data point to view the summary data.
  - Work with the data using the available tools on the **Analyse** menu. For example, choose the Graph Trace tool and press the arrow keys to move across the dots in the plot and view the values.

### Working with Categorical Plot Types

You can sort and group data using the categorical plot types:

- Dot Chart
- Bar Chart
- Pie Chart

The categorical plot types can be used to compare the representations of data across different plots. When the same variable (list) is used for a dot chart and a bar chart or pie chart in a problem, selecting a data point or segment in one of the plots selects the corresponding data point, segment or bar in all other plots that include the variable.

## Creating a Dot Chart

The default plot type for categorical data is the dot chart.

When one variable is plotted, the value of each cell is represented as one dot, and the dots are stacked at the point on the axis that corresponds to the cell value.

1. In Lists & Spreadsheet, create a spreadsheet that includes at least one column of string values that can be used as categories for data.

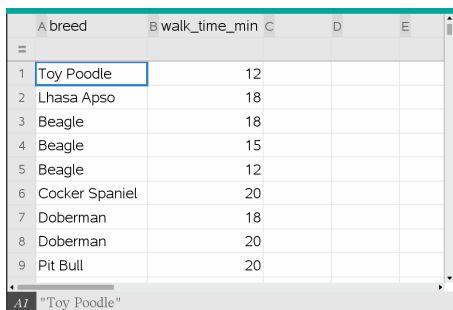

	A breed	B walk_time_min	C	D	E
1	Toy Poodle	12			
2	Lhasa Apso	18			
3	Beagle	18			
4	Beagle	15			
5	Beagle	12			
6	Cocker Spaniel	20			
7	Doberman	18			
8	Doberman	20			
9	Pit Bull	20			

**Note:** To type a string in Lists & Spreadsheet, enclose the characters in quotes.

2. Add a Data & Statistics page to the problem.

Notes:

- You can also use the Lists & Spreadsheet Quick Graph tool to automatically add a Data & Statistics page and plot the selected column.
  - The new Data & Statistics work area displays a default caseplot with a caption, variable name and unplotted data points for the variable. You can click the variable name in the caption to choose another variable for previewing, or drag a default data point toward an axis to plot the current variable.
3. Move near the centre of either axis and click the Add List region. The list of variables displays.

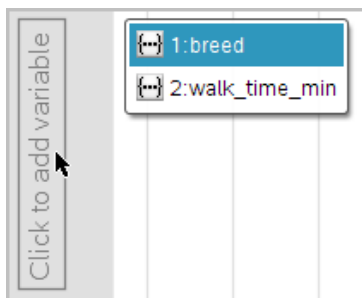

4. Click the list that contains the categories you want to use for sorting data.



A dot chart plots in the work area. The application labels the axis with the variable name and shows a dot for each instance of a category.

5. Explore the plotted data.
- Hover over a dot in the plot to display data values.
  - Click a dot to select it. Click the dot a second time to deselect it or remove it from a selection of multiple dots.
  - Activate the Graph Trace tool and press ◀ or ▶ to move across the points in list order. Dots display a bold outline as you move across them in Trace mode.

### Creating a Bar Chart

Like dot charts, bar charts display categorical data. The length of a bar represents the number of cases in the category.

1. Click the Add Variable region of either axis and choose the name of a categorical variable. For more information, see *Creating a Dot Chart*.
2. On the **Plot Types** menu, click **Bar Chart**.

The dot chart changes to a bar representation of the data.



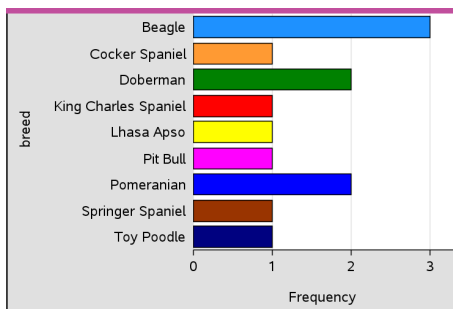

### 3. Explore the data in the plot.

- Hover over a bar to see a category summary (the number of cases and percentage among all categories).
- Activate the Graph Trace tool and press ◀ or ▶ move across the bars and view summary information.

### Creating a Bar Chart from a Frequency Table or Summary Data

1. On a new Data & Statistics page, create a bar chart with frequency or summary data by choosing **Add X Variable** on the **Plot Properties** menu.

**Note:** You can also create a bar chart with frequency by selecting **Add Variable with Summary List** from the context menu of the Add Variable region of an axis.

2. Select the desired variable from the pop-up choices.
3. Set the height of the bars with the summary variable by selecting **Add Summary List** from the **Plot Properties** menu.
4. Select the summary list from the pop-up choices.

The bar chart plots on the work area. The icon in the lower left corner indicates that this plot was generated from summary data.

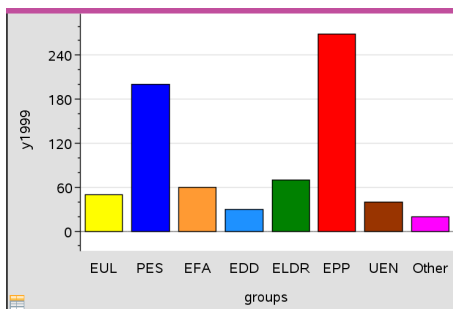

5. Hover over a bar to see a category summary, or use the Graph Trace tool on the **Analyse** menu to move across all of the bars displaying the summaries.
6. (Optional) Add summary lists to create a comparative bar chart.

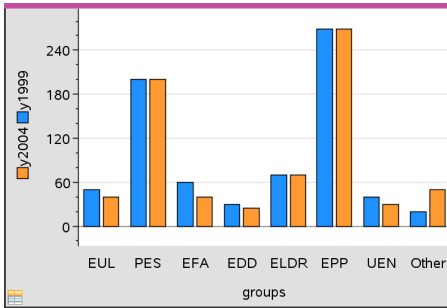

### Creating a Pie Chart

A pie chart represents categorical data in a circular layout and uses an appropriately proportioned segment for each category.

1. Create a dot chart on the work area.
2. On the **Plot Types** menu, click **Pie Chart**.

The dots move by category into the segments of the pie chart.

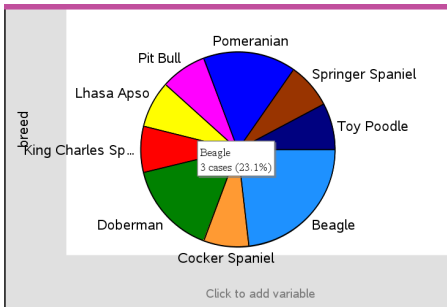

3. Hover over a segment to see the summary for the category, or use the Graph Trace tool on the **Analyse** menu to move across each segment displaying all of the summaries. The summary shows the number of cases for the category and the percentage among all cases.

**Note:** You can switch to a pie chart from a bar chart generated from summary data.

## Creating a Comparative Bar Chart

This might be used to explore data in a two-way table.

1. Type the raw data on a Lists & Spreadsheet page.

	A person	B ht	C wt	D eyecolor	E gender	F
1	1	56	130	blue	f	
2	2	55	150	blue	m	
3	3	60	200	green	f	
4	4	62	270	brown	m	
5	5	65	250	brown	f	
6	6	71	187	green	m	
7	7	62	176	brown	m	

2. From the **Insert** menu in the toolbar, click **Data & Statistics**.

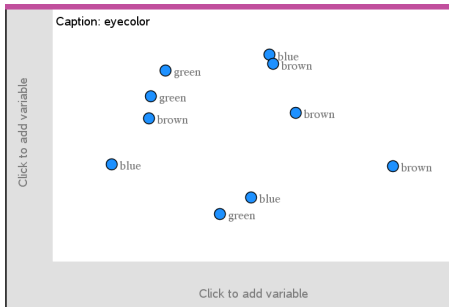

**Note:** Your screen may differ, depending on the data you entered.

3. Select the **Click to add variable** field, and select **eye colour** as the variable for the x axis.
4. On the **Plot Type** menu, click **Bar Chart**.

The frequency of the eye colour data is plotted.

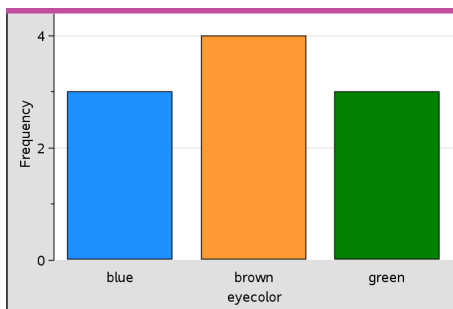

- To split the eye colour data by gender, click the **Plot Properties** menu, click **Split Categories by Variable** and then click **gender**.

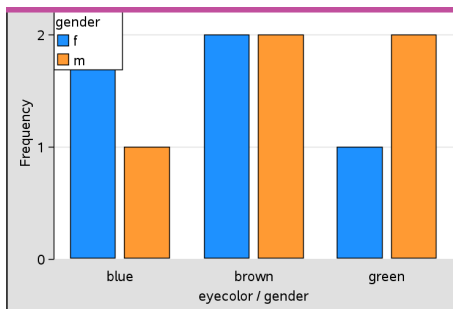

### Splitting a Numeric Plot by Categories

You can use a categorical split to sort the values plotted on an axis.

- Open a problem that includes a Lists & Spreadsheet page, or create data to be plotted in the Lists & Spreadsheet application.

In this example, lists contain dog breed and daily walk information.

	A breed	B walk_time_min	C	D	E
=					
1	Toy Poodle	12			
2	Lhasa Apso	18			
3	Beagle	18			
4	Beagle	15			
5	Beagle	12			
6	Cocker Spaniel	20			
7	Doberman	18			
8	Doberman	20			
9	Pit Bull	20			

- Click column letter (B).
- On the Lists & Spreadsheet **Data** menu, click the **Quick Graph** tool.

The Quick Graph tool adds a Data & Statistics page. Data & Statistics plots the variable and labels the horizontal axis.

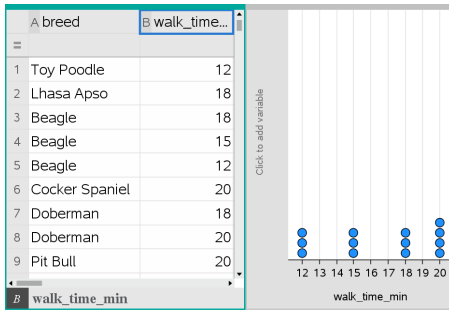

- To plot the numeric data for each category, hover on the Add Variable region near the centre of the vertical axis and click the tooltip **Click or Enter to add variable**.

The list of available variables displays.

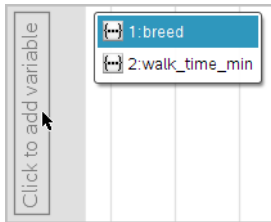

- On the list of variables, click the name of the category variable.

Data & Statistics labels the vertical axis and plots the numeric data for each category.

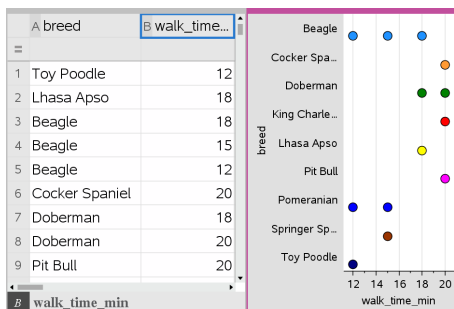

## Exploring Data

You can manipulate and explore plotted data.

### Moving Points or Bins of Data

1. Click and hold the desired point or bin.

The pointer changes to an open hand .

2. Drag the point or bar to the new location and release it. Moving the point changes the values for x and y.

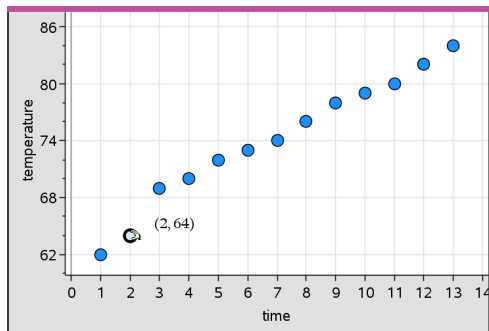

If you are working with data from Lists & Spreadsheet, the data that corresponds to the original point or bar automatically updates in the original column(s) in Lists & Spreadsheet as you move the point.

You can also move points or bins by changing the numbers in the Lists & Spreadsheet or Calculator applications. Data will update in all of the representations.

## Moving Multiple Points

1. Position the pointer over each data point that you want to select. When the pointer changes to an open hand , click to add the point to the selection.

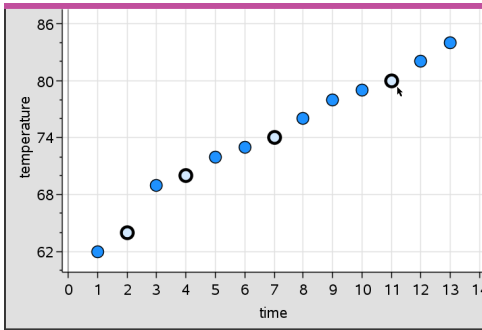

Alternatively, you can drag a selection rectangle around the points to select them.

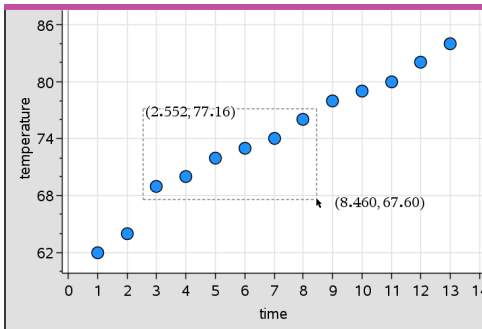

2. Drag any of the selected points to move them all.

**Note:** When a list is defined in Lists & Spreadsheet as a formula, the movement of points is restricted to positions that satisfy the formula.

## Sorting Plotted Categories

You can sort plotted categories in list order, value order or alphabetically by category name.

1. Click the work area that contains the plotted data.
2. On the Actions menu, click Sort and then click the type of sort.

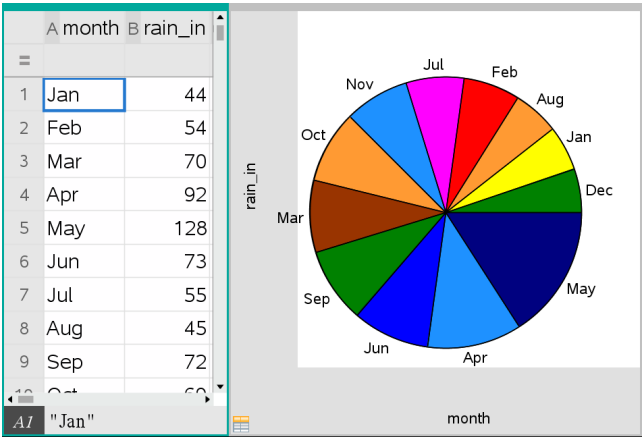

Months listed chronologically but sorted by value (amount of rainfall)

**Note:** You can customise the order of the categories by clicking a label and dragging it.

**Plotting a Value**

You can plot a value on an existing plot. It displays as a vertical line in the work area.

1. From the **Analyse** menu, click **Plot Value**.

A text box with a default expression opens in the work area.

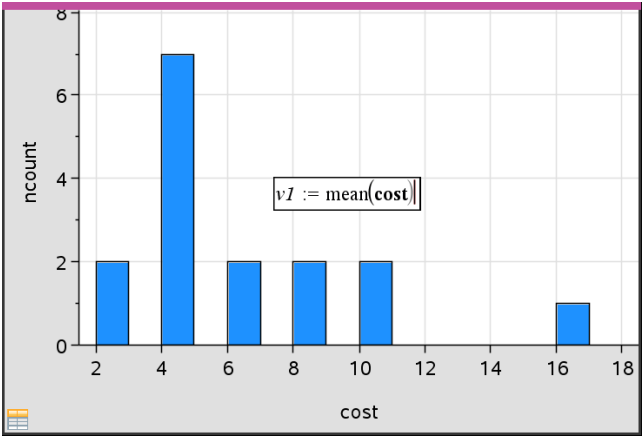

2. Type the value you want to plot, and press **Enter**. In this example, the value is `v1:= mean(cost)`.



The line is drawn at that value, perpendicular to the axis. If you have multiple plots on the work area, a plot value segment displays for each plot.

**Note:** If you use a frequency table to generate a histogram, reference the frequency list in your expression. For example, type the expression "v1:= mean(List, FreqList)" in the plot value entry box.

3. Click the line to display the value.

**Note:** Double-click the value to edit the expression.

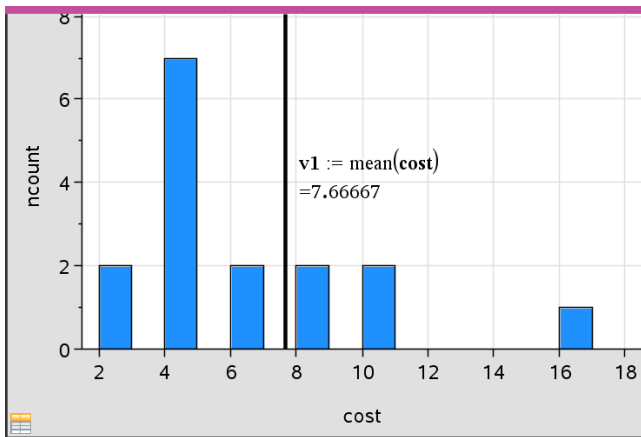

*Plot value with value displayed*

You can use Plot value for a single number or any expression that evaluates to a number. If the value is dependent on the data, like **mean**, when you drag a point or make changes in the Lists & Spreadsheet application, the line updates to reflect the change, allowing for investigation of the influence of points on the calculation.

### Removing a Plotted Value

1. Select the plotted value line.
2. From the **Actions** menu, click **Remove Plotted Value**.

### Changing the Plot Type

You can change the plot type, to view different representations of data.

- ▶ On the **Plot Type** menu, click a new plot type. Only the supported plot types are available. For example, only univariate plot types are available when a single variable plotted on an axis.

The data representation changes to the new plot format.

**Note:** Options are unavailable on the menu if the plotted data cannot be represented by the plot type. For example, if a scatter plot is displayed in the work area, you cannot create a box plot without first removing the variable from the y-axis.

## Rescaling a Graph

You can change the scale of the axes by using Translation and Dilation. The pointer changes to indicate whether Translation (+) or Dilation (⊕) is available in zones on the axes.

### Translation

A translation slides a set of axes a fixed distance in a given direction. The original axes have the same shape and size.

1. Position the pointer over a tick mark or label in the middle third of the axis. The pointer changes to ⊕.

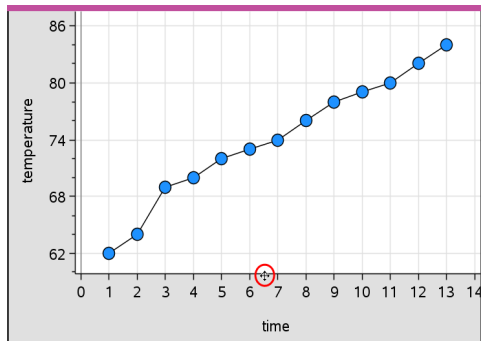

2. Click to grab. The pointer changes to a grasping hand . Drag to the desired position and release.

### Dilation

Dilation retains the shape of the axes, but enlarges or reduces the size.

1. Position the pointer over a tick mark or label near the ends of the axis. The pointer changes to ⊕ on the vertical axis or ⊕ on the horizontal axis.

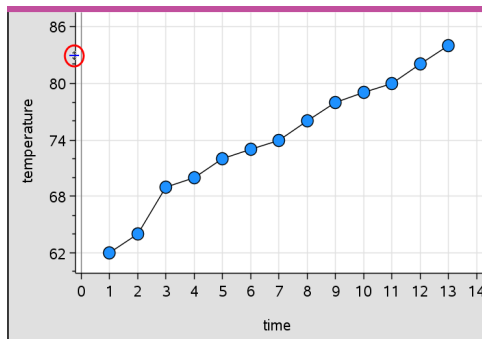

- Click to grab. The pointer changes to an open hand . Drag to the desired position and release.

### Adding a Movable Line

You can add a movable line to a plot. Moving and rotating the line on the work area changes the function that describes it.

- From the **Analyse** menu, click **Add Movable Line**.

The movable line displays and is labelled with a function that describes it. For this example, Data & Statistics stores the expression for the movable line in the variable *m1*.

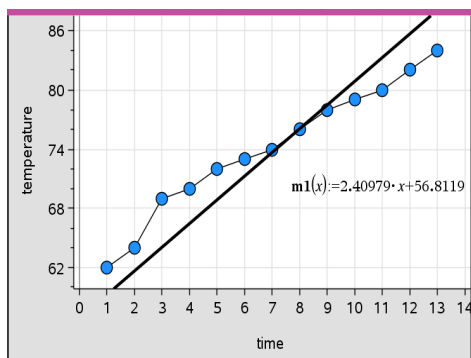

### Rotating a Movable Line

- Click and grab either end of the line.

The pointer changes to .

2. Drag to rotate and change the slope of the line.

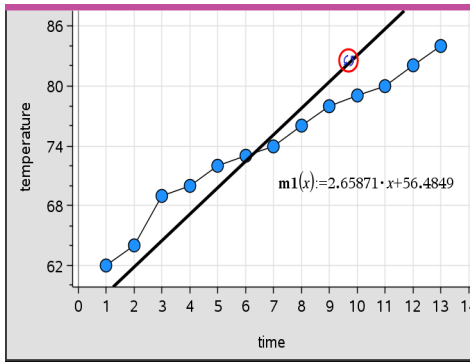

The function  $m1(x)$  is updated for the changes in the position of the movable line.

### ***Changing the Intercept***

1. Click in the middle of the movable line.

The pointer changes to  $\nabla$ .

2. Drag to change the intercept.

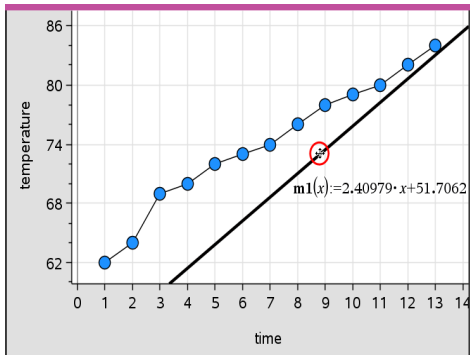

The number at the end of the equation changes to show the change in the intercept.

**Note:** The movable line is stored as a function that can be used for prediction in the Calculator application.

### ***Locking the Intercept at Zero***

You can lock the intercept of the movable line at zero.

- ▶ From the **Analyse** menu, click **Lock Intercept at Zero**.

You can unlock the intercept by choosing **Unlock Movable Line Intercept** on the **Analyse** menu.

### Tracing a Movable Line

You can trace a movable line to predict and analyse values.

1. Click the line.

The pointer changes.

2. From the **Analyse** menu, click **Graph Trace** to enable Trace mode for the line. Rotation of the line is not supported in Trace mode.
3. Press ◀ or ▶ (left or right arrow keys) to trace the movable line.

If the plotted variables change, points on the graph and the line are updated automatically.

### Showing a Line of Regression

You can show a line of regression when you have a scatter plot or an X-Y line plot on the work area. Studying the line of regression can help you understand the relationship between two variables.

1. With a scatter plot or X-Y line plot of two variables on the work area, click the **Analyse** menu, choose **Regression** and view the list of regressions.
2. Click the type of regression line to show. For example, choose **Show Linear (mx+b)** to plot a linear regression line as shown in the following example.

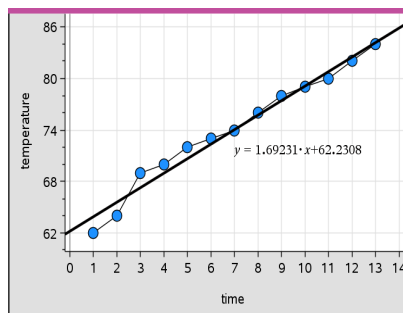

When the line of regression is selected, the expression for the line displays.

## Showing Residual Squares

You can display residual squares on a plot. Residual squares can help you assess the appropriateness of the model for your data.

**Note:** This tool is only available when a regression or movable line is present in the work area.

- ▶ From the **Analyze** menu, click **Residuals** > **Show Residual Squares**.

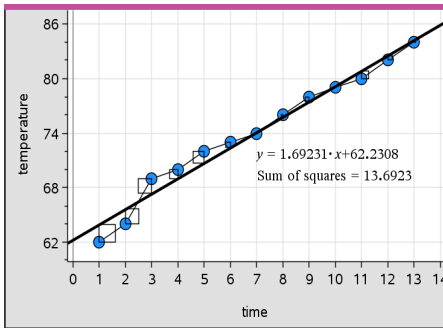

The sum of squares is updated as the line or data changes.

## Showing a Residual Plot

You can show a residual plot to determine how well a line fits data. The work area must include a scatter plot and one or more movable lines, regressions or plotted functions for **Show Residual Plot** to be available.

- ▶ With a scatter plot, line of regression and/or movable line in the work area, click the **Analyze** menu and click **Show Residual Plot** > **Residuals**.

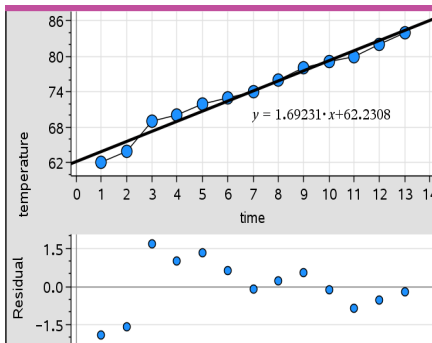

## Notes:

- With multiple regressions or functions and movable lines plotted, you can select each by clicking the line to show its residual plot.
- Click and hold a dot on the residual plot to see the residual.
- The residual plot for the selected regression or function displays in the work area.
- For consistency in comparing sets of data, residual plots do not rescale when you move from one function or regression to another.
- Select a function or regression before a showing residual plot. If no function or regression is selected and there are several plotted, Data & Statistics arbitrarily selects the function or regression for showing the residual plot.
- Axes can be adjusted by clicking and dragging.

## Removing a Residual Plot

- ▶ With a scatter plot, line of regression and/or movable line in the work area, click the **Analyse** menu, and click **Hide Residual Plot**.

## Using Window/Zoom Tools

Use the Window/Zoom tools to redefine the graph to better view points of interest. The Window/Zoom tools include:

- **Window Settings:** displays a Window Settings dialogue box that lets you type the x-min, x-max, y-min, and y-max values for the axes.
- **Zoom - Data:** adjusts the zoom factor to display all plotted data.
- **Zoom - In:** lets you define the centre point of the zoom in location. The Zoom In factor is approximately 2.
- **Zoom - Out:** lets you define the centre point of the zoom out location. The Zoom Out factor is approximately 2.

## Using the Window Settings Tool

1. On the **Window/Zoom** menu, click **Window Settings**.

The **Window Settings** dialogue box opens. The current values for x-min, x-max, y-min and y-max are displayed in the fields.

**Note:** Only the appropriate boxes are editable, depending on whether there are one or two axes in the work area.

2. Type the new values over the old values.
3. Click **OK** to apply the changes and redraw the plot.

## Using the Zoom Data Tool

- ▶ On the **Window/Zoom** menu, click **Zoom Data**.

The work area rescales to display all plotted data.

### **Using the Zoom In Tool**

1. On the **Window/Zoom** menu, click **Zoom In**.
2. In the work area, click the centre point of the area of interest. This will be the centre of the zoom in action.

The plot redraws to focus and enlarge the portion of the plot centred about the point you selected in the previous step.

### **Using the Zoom Out Tool**

1. On the **Window/Zoom** menu, click **Zoom Out**.
2. In the work area, click the centre point of the area of interest. This will be the centre of the zoom out action.

The plot redraws to display a larger portion of the plot, centred about the point you selected in the previous step.

## ***Graphing Functions***

You can graph functions by typing them in Data & Statistics, or you can graph functions defined in other applications.

### **Graphing Functions Using the Plot Function Tool**

You can use the Plot Function tool to plot functions in a work area that already includes a plot on the axes. Plot Function lets you specify and graph a function for comparison to an existing plot.

To use the Plot Function tool:

1. Create or open a problem that includes variables (from Lists & Spreadsheet) that are plotted on a Data & Statistics work area. Ensure that your work area contains both a horizontal axis and a vertical axis scale.
2. From the **Analyse** menu, click **Plot Function**.

A function entry field displays in the work area.



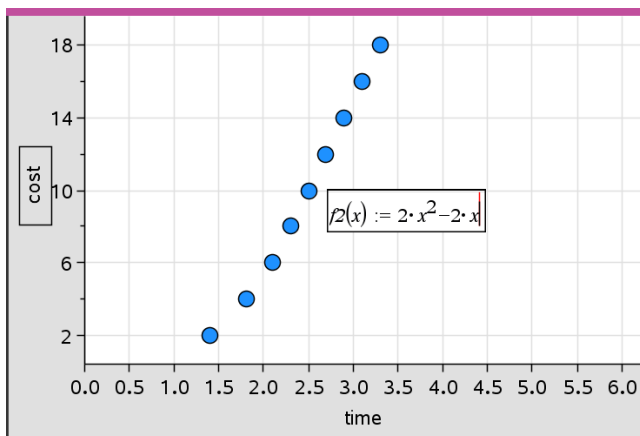

**Note:** You can edit the function's expression typed in the entry field. However, the function graphed in Data & Statistics cannot be manipulated or moved around the work area. To do that, use Graphs & Geometry.

3. Type the function in the entry field, and press **Enter**.

**Note:** You can rename the function by typing over  $f_1(x)$ : with another name, if you choose.

The function graphs in the work area and is saved as a variable for use in other applications.

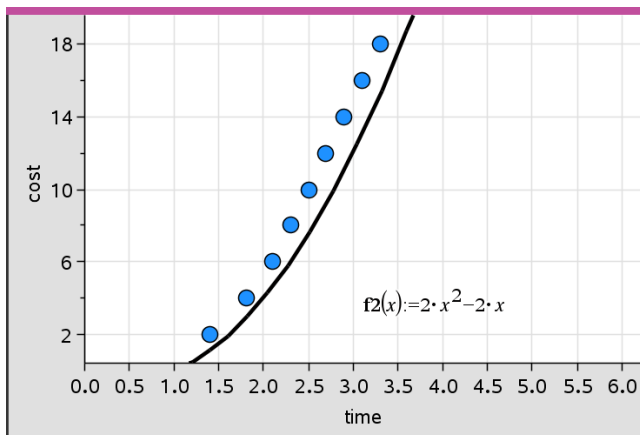

## Entering Functions from Other Applications

You can enter a function that has been defined as a variable in another application, such as Lists & Spreadsheet, Graphs & Geometry or Calculator.

1. Add a variable to each axis. You can access any variables defined in a Lists & Spreadsheet or Calculator application in your problem from the variable list.
2. From the **Analyse** menu, click **Plot Function**.

A function entry field displays in the work area.

$$f1(x) :=$$

3. Click  on the toolbar.

Handheld: Press .

A list of variables available in the problem displays.

4. Click to select the variable containing the function you want to plot.

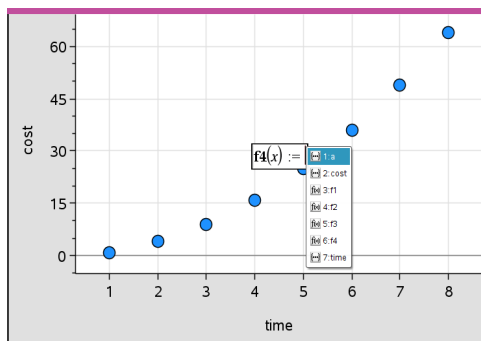

In the example below, the variable  $a$  contains the function  $f(x)=x^2$ .

5. Press **Enter**.

The function plots in the work area.

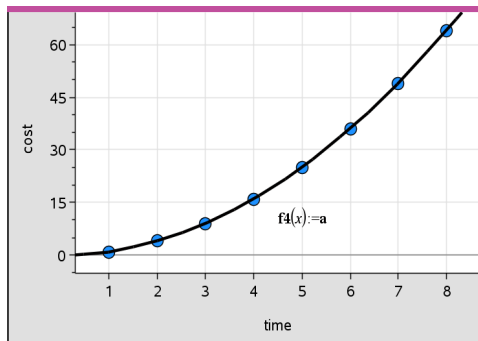

## Editing a Function

You can edit a function and update it in the work area.

1. You can edit a function by double-clicking the equation and then making changes as required.
2. Press **Enter** after making all changes and the updates are displayed in the work area.

## Using Data & Statistics Functions in other Applications

Data & Statistics functions are stored as variables, and may be used in other applications, in the same manner as any other variable. Support for all function types is included.

**Note:** Function numbers increment to use the next available. If you have defined  $f_1(x)$  and  $f_2(x)$  in Graphs & Geometry, the first function you create in Data & Statistics will be  $f_3(x)$ .

## Using Show Normal PDF

You can approximate data plotted in the Data & Statistics work area against the normal probability density function. The tool overlays the normal probability density function using the mean and the standard deviation of the data in the histogram.

To show the normal probability density function for plotted data:

1. Add a variable to the x-axis.
2. On the **Plot Types** menu, click **Histogram**.

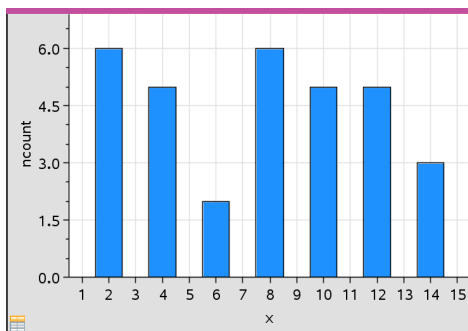

**Note:** Show Normal PDF is available only when histogram is the plot type.

- From the **Analyze** menu, click **Show Normal PDF**.

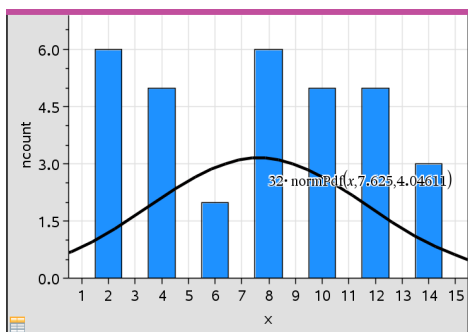

The normal PDF for the graph plots in the work area. The expression used to calculate the PDF displays when selected.

You can click **Hide Normal PDF** on the **Analyze** menu to remove the PDF.

### Using Shade Under Function

Use Shade Under Function to find the area of a selected region under a function graphed in the work area.

- Select any function graphed in the Data & Statistics work area. For example, select a previously graphed normal PDF.
- From the **Analyze** menu, click **Shade Under Function**.

The pointer becomes a dotted vertical line and the boundary  $\pm \infty$  displays when you position the mouse near the boundary on the left or right. You can click when  $\infty$  displays to set it as a boundary.

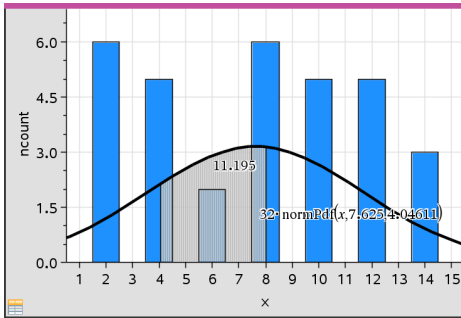

3. Select a point on the curve and click to indicate where to start shading under the function. The direction in which you move next determines whether the region shaded is on the left, right or centre of the curve.
4. Select a point on the curve and click to indicate the end boundary of the shaded area. A region under the function is shaded based on the points you selected.

You can work with Shade Under Function in the following ways:

- Select the region to display the values for data points in the shaded area.
- To remove the shading, right-click or **Ctrl**-click the shaded region and choose **Remove Shaded Region**.
- To change the fill colour of the shaded area, right-click or **Ctrl**-click the shaded region, choose **Colour**, choose **Fill** and click a colour.
- Use plot value to set the boundary to an exact number. When a boundary for shading is set to a plotted value, you can change the plotted value to update the shading.
- Edit a shaded region by clicking and dragging the edge at the starting or ending boundary.

## Using Graph Trace

Graph Trace lets you move from one point on a graph to another to analyse variations in the data. You can use Graph Trace mode to explore the data for the following graphs.

- Graphs from Plot Function and Show Normal PDF
- Distribution curves (created in the Lists & Spreadsheet application)
- Movable Lines

- Regressions
- Caseplots
- Dot plots
- Scatter plots and X-Y line plots
- Box plots
- Histograms
- Bar charts
- Pie charts

### To use Graph Trace

1. From the **Analyse** menu, click **Graph Trace**.
2. Press ◀ or ▶ to move across the plot.

The data representations enlarge and appear with a bold outline as you move across them in Trace mode.

## Customising Your Workspace

### Working with Colour

All data points for a plotted variable display in the same colour to distinguish them from the data points of other variables. Data plotted by category and split plots are automatically displayed in different colours to help you distinguish the data.

To emphasise or distinguish certain parts of your work, you can change the default colour for a variable's data.

- Apply fill colours to objects, such as shading, or change the colour for a variable's data points.
- Apply colour to plotted lines (such as lines of regression) or movable lines.

### Inserting a Background Image

When using the computer software, you can insert an image as a background for a Data & Statistics page. The file format of the image can be .bmp, .jpg or .png.

1. From the **Insert** menu, click **Image**.
2. Navigate to the image that you want to insert.
3. Select it, and then click **Open**.

The image is inserted as a background.

For more information, see the *Working with Images* chapter.

## Working with Text

The Insert Text tool lets you type text to describe details related to plots on the work area.

1. From the **Actions** menu, click **Insert Text**.

A text box opens.

2. Type notes or descriptions in the text box.

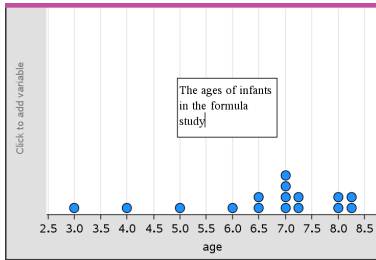

3. Customise the text to suit your needs.
  - Move the pointer over the edges of the text box to drag the borders and change the width or height.
  - Click and grab the text box to move it near objects that relate to the text.
  - Scroll to view additional text in a box by clicking the arrows at the top and bottom edge.
  - Click outside of the text entry box to exit the Text tool.
  - Hide text by clicking the **Actions** menu and clicking **Hide Text**.
  - Change the colour of text.

## ***Adjusting Variable Values with a Slider***

A slider control lets you interactively adjust or animate the value of a numeric variable. You can insert sliders in the Graphs, Geometry, Notes and Data & Statistics applications.

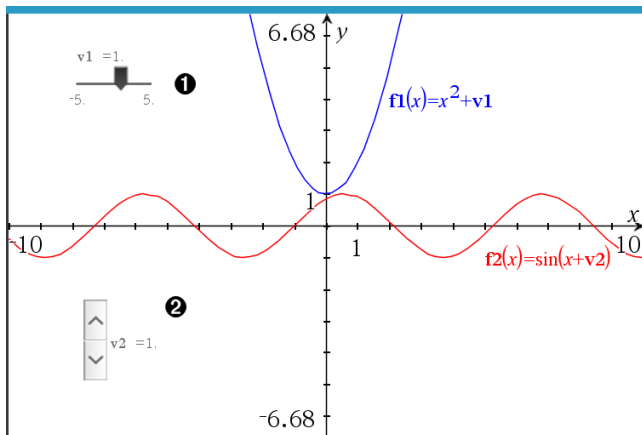

- ❶ Horizontal slider for adjusting variable  $v1$ .
- ❷ Minimized vertical slider for adjusting variable  $v2$ .

**Note:** TI-Nspire™ version 4.2 or higher is required for opening .tns files containing sliders on Notes pages.

### Inserting a Slider Manually

1. From a Graphs, Geometry or Data & Statistics page, select **Actions > Insert Slider**.  
—Or—  
From a Notes page, make sure the cursor is not in a maths box or chem box, and then select **Insert > Insert Slider**.

The Slider Settings screen opens.

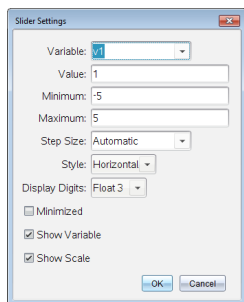

2. Enter the desired values, and click **OK**.

The slider is displayed. On a Graphs, Geometry or Data & Statistics page, handles are displayed to let you move or stretch the slider.



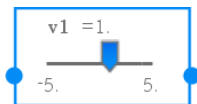

To remove the handles and use the slider, click an empty space in the work area. You can show the handles any time by selecting **Move** from the slider's context menu.

- To adjust the variable, slide the pointer (or click the arrows on a minimised slider).
  - You can use the **Tab** key to move the focus to a slider or to move from one slider to the next. The colour of the slider changes to show you when it has the focus.
  - When a slider has the focus, you can use the arrow keys to change the value of the variable.

### Working with the Slider

Use the options on the context menu to move or delete the slider, and to start or stop its animation. You can also change the slider's settings.

- Display the slider's context menu.

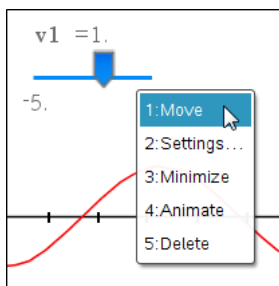

- Click an option to select it.

### Automatic Sliders in Graphs

Sliders can be created for you automatically in the Graphs application and in the analytic window of the Geometry application. You are offered automatic sliders when you define certain functions, equations or sequences that refer to undefined variables.

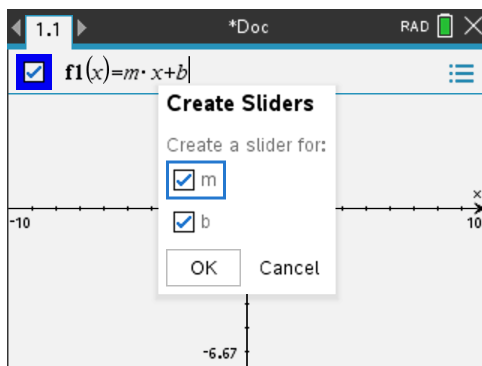

## Inferential Statistics

You can explore hypothesis tests and probability distributions in the Data & Statistics application after entering the data on a Lists & Spreadsheet page.

### Drawing Inferential Statistics Plots

The following example uses the Draw option of the **normCdf()** function to plot a distribution model.

1. On a Lists & Spreadsheet page, select the column-formula cell (second cell from the top) in column A.
2. From the **Statistics** menu, click **Distributions**, and click **Normal Cdf**.

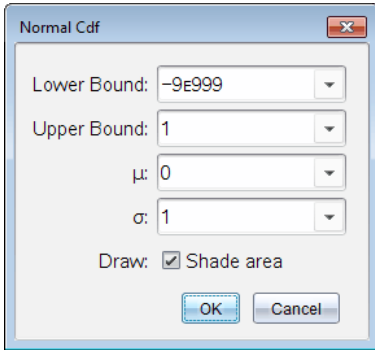

3. Type the plot parameters into the **Normal Cdf** wizard.
4. Select the **Draw** box to see the distribution plotted and shaded in Data & Statistics.

**Note:** The Draw option is not available for all distributions.

5. Click **OK**.

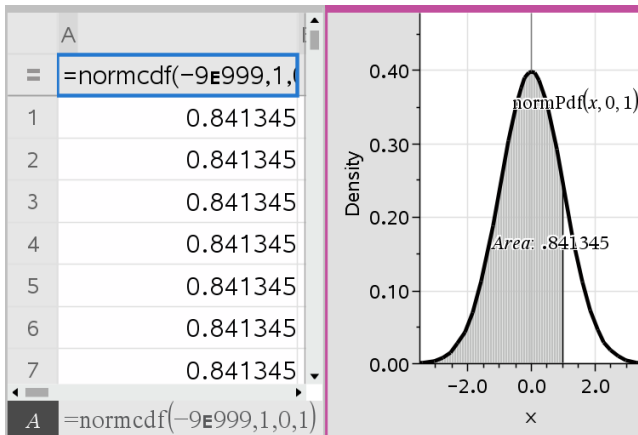

## Exploring Inferential Statistics Plots

After drawing the plot in the previous example, you can explore the effect of changing the upper bound.

- ▶ On the Data & Statistics plot, drag the vertical line that represents the upper bound toward the left or right.

As you drag, the formula is updated and the shaded area is recalculated.

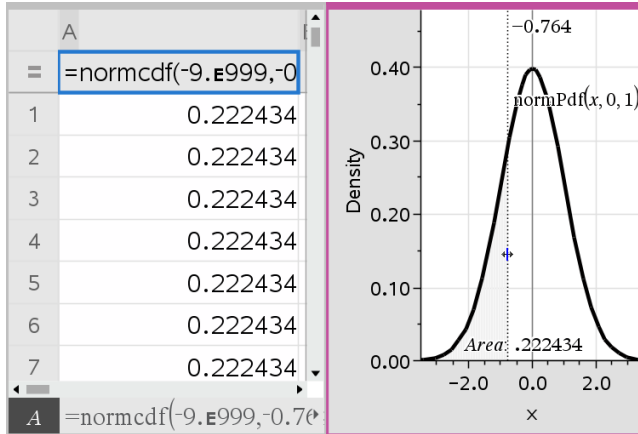

# Notes Application

The Notes application lets you create and share text documents using the TI-Nspire™ handheld and computer software. Use **Notes** to:

- Create study notes to reinforce learning, demonstrate your understanding of classroom concepts and review for exams.
- Edit collaboratively by assigning different roles to individuals using your document so that any edits appear in a different text format.
- Create and evaluate maths expressions.
- Create correctly formatted chemical formulas and equations.

## Adding a Notes Page

- To start a new document with a blank Notes page:

From the main **File** menu, click **New Document** and then click **Add Notes**.

Handheld: Press **[on]**, and select **Notes** .

- To add a Notes page in the current problem of an existing document:

From the toolbar, click **Insert > Notes**.



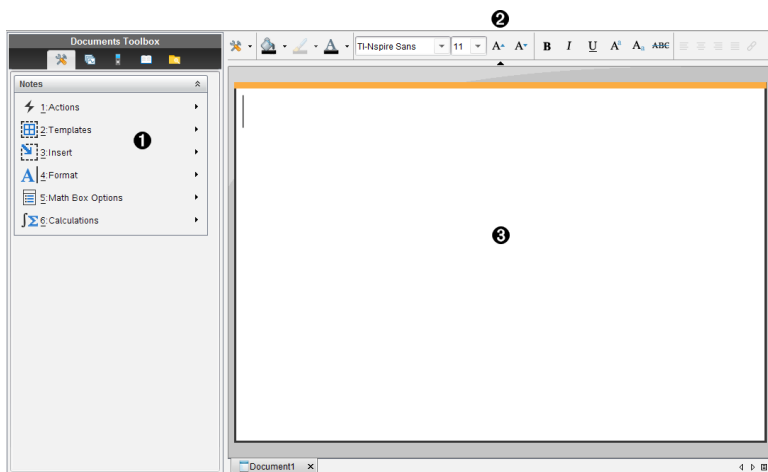

Handheld: Press **[doc]** and select **Insert > Notes**.



- ① Notes tools – Available any time you are in the Notes work area.
- ② Text formatting toolbar - Lets you change size, colour, bold and other text properties.
- ③ Notes work area - The area where you type and format text.

## Using Templates in Notes



Use the options on the Templates menu to select a format for your Notes page.

	Menu Option	Function
	 2: Templates	
	 1: Q&A	Creates a template to enter question and answer text.
	 2: Proof	Creates a template to enter statement and reason text.
	 3: Default	Lets you type freeform text.
	 4: Hide Answer (Q&A)	Toggles to show or hide the Answer in a Q&A format.

### Selecting a Template

Complete the following steps to select and apply a template:

1. From the Notes menu, click .
2. From the menu, click the template you want to apply.

Handheld: From the Notes work area, press , and then press  to display the menu options.

The Notes page is displayed in the format you selected.

### Using the Q&A Template

Use the Q&A template to create questions and answers. You can show or hide the answer so you can create questions for review and hide the answers. When you use the document as a study aid, you can verify that your answers are correct.

Press **Tab** to move the text cursor between the **Question** and **Answer** areas of the template.

### Using the Proof Template

The proof template provides an outline structure for statements and corresponding reasons.

Press **Tab** to move the text cursor between the **Statements** and **Reasons** areas of the template.

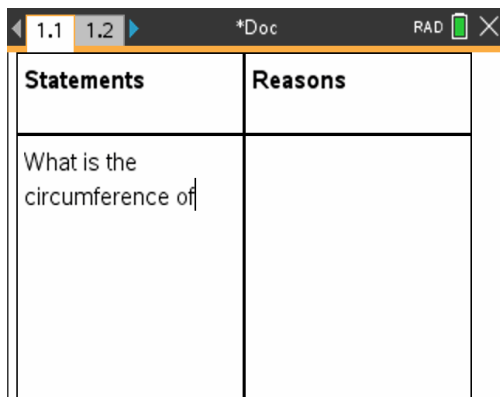

## Formatting Text in Notes

Text formatting lets you apply visual properties, such as bold and italic, to your text.

- **Ordinary text.** Apply most combinations of bold, italic, underline, superscript, subscript, and strikethrough formatting. Select font and font size for any character.
- **Text in a maths expression box.** Apply formatting and enter maths exponents and maths subscripts for variable names. Select font and font size. Font size affects all text in the box.
- **Text in a chemical equation box.** Apply formatting. Select font and font size. Font size affects all text in the box. Superscript and subscript are handled automatically.

### Selecting Text

- ▶ Drag from the starting point to the ending point to select the text.

Handheld: If you are using the Q&A or Proof template, press **tab** to place the cursor in the area containing the text. Use the Touchpad to place the cursor at the start or end of the text to be selected. Hold down **qshift**, and use the Touchpad to select the text.

### Applying a Text Format

1. Select the text that you want to format.
2. On the formatting toolbar, click the formatting icons (such as **B** for bold) to toggle them, or click to select a font and font size.

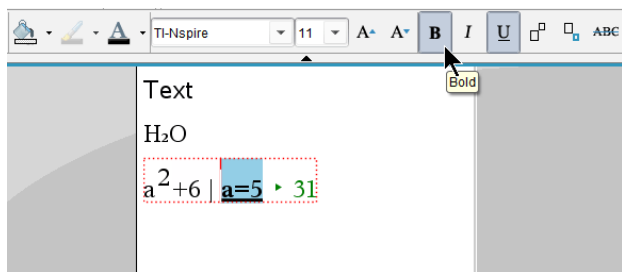

Handheld: Click **menu**, and then select **Format > Format Text**.

The changes are applied to the text as you make selections.



**Note:** The toolbar shows only the icons that are applicable to the type of text selected. For example, superscript ( $A^x$ ) and subscript ( $A_x$ ) are shown only for ordinary text.

## Using Colour in Notes

When working in the Notes application on a desktop, use the  (fill colour) or the  (text colour) options on the Documents Workspace toolbar to emphasise words, calculations and formulas.

You can also apply colour to text when working in the Notes application on the TI-Nspire™ CX handheld.

### Changing Text Colours

1. Select the text you want to change to another colour. You can select a sentence, phrase, word or a single letter. You can also select a maths expression box, a chemical equation box or individual characters in a calculation, formula, chemical equation or maths template.
2. From the Documents Workspace toolbar, click .

Handheld: Press , and then click **Edit > Text Colour**.

The Text Colour palette opens.

3. Click a colour to apply it to the selected text.

### Applying a Background Colour

You can apply a background colour to highlight selected characters in ordinary text, text in a maths expression or text in a chemical equation box.

1. Select the text.
2. From the Documents Workspace toolbar, click the arrow next to .

Handheld: Press , and then press **Edit > Fill Colour**.

The Fill Colour palette opens.

3. Click a colour to apply it to the selected text.

## Inserting Images

When working in the Notes application on a desktop, use the Images option on the Insert menu to add an image to a Notes page.

**Note:** The option for inserting an image is not available when working on a handheld. However, you can transfer a file containing an image from your computer to a TI-Nspire™ CX handheld and colours are retained.

1. Click **Insert > Image** from the Documents Toolbar.

The Insert Image window opens.

2. Navigate to the folder where the image is located.
3. Select the image, and then click Open to insert the image into the Notes work area. Valid files types are .jpg, .png or .bmp.
4. To type text around the image, place the cursor in front of the image or after the image, and then type the text.

## Resizing an Image

Complete the following steps to resize an image.

1. Click the image to select it.
2. Move the cursor to the edge of the image.



The cursor changes to a left-right arrow symbol.

3. Click the mouse and hold to enable the  tool, and then drag the image to make it smaller or larger.
4. Release the mouse button when the image is sized correctly.





For more information, see *Working with Images*.

## Inserting Items on a Notes Page

When working with the Notes application, open the Insert menu to insert a maths expression, chemical equation, shape symbol, or a comment.

Menu Name	Menu Option	Function
 3: Insert		
	 1: Math Box -  M	Lets you insert a maths expression.



Menu Name	Menu Option	Function
	 2: Chem box -  E	Lets you insert a chemical formula or equation.
	 3: Shape	Marks the selected text as an angle, triangle, circle, line, segment, ray, or vector.
	 4: Comment	Lets you type text that is italicised and prefaced with <b>Teacher</b> or <b>Reviewer</b> .
	 5: Slider	Lets you insert a slider.

## Inserting Comments

You can insert Teacher or Reviewer comments into a Notes application. Comments are easy to distinguish from the original text.

- Define the type of comments you're inserting (Teacher or Reviewer):
  - On the **Insert** menu, click **Comment**, and then click **Teacher** or **Reviewer**.
  - Handheld: While in the Notes work area, press  to display the Notes menu. Press **Insert > Comment**, and then either **Teacher** or **Reviewer**.
- Type your text.

Text that you type appears in italics.

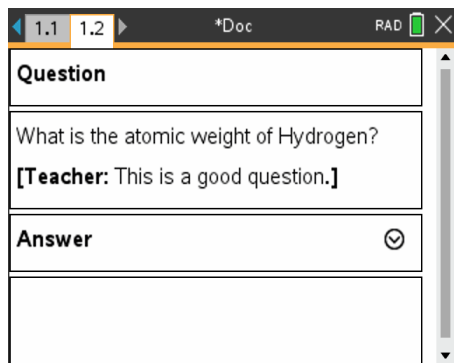

## Inserting Geometric Shape Symbols

You can use geometric shape symbols to designate selected text as geometric objects, such as an angle, circle or line segment.

To insert a shape symbol, position the cursor where you want it, and then do the following:

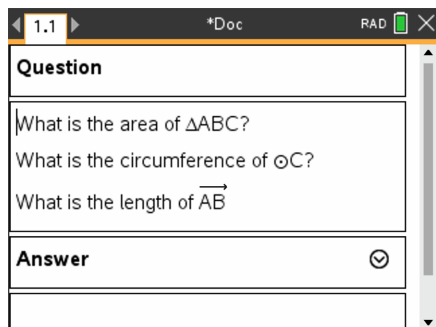

- On the **Insert** menu, click **Shapes**, and then select the shape to apply.
- Handheld: Press **[menu]** to display the Notes menu. On the **Insert** menu, press **Shapes**, and then press the shape to apply.



## Entering Maths Expressions in Notes Text

You can include maths expressions in Notes text, using the same tools as in other TI-Nspire™ applications.

Maths expression boxes have attributes that allow you to control how the expression is displayed.

Menu Name	Menu Option	Function
 5: Maths Box		
Options		
	 1: Maths Box Attributes	When a maths box is selected, this option opens a dialogue box allowing you to customise the maths box. You can hide or show input or output, turn off calculation for the box, insert symbols, change display and angle settings, and allow or disallow the wrapping of expressions and the display of warning indicator after they have been dismissed. You can change the attributes of multiple selected maths boxes at the same time.
	 2: Show Warning Info	Displays a warning indicator after the warning has been dismissed.

Menu Name	Menu Option	Function
	 3: Show Error	Displays an error after the error has been dismissed.

### Entering an Expression

1. In the Notes work area, position the cursor where you want the expression.
2. From the **Insert** menu, select **Maths Box**.  
—or—  
Press **Ctrl + M** (Mac®: Press **⌘ + M**).









An empty maths expression box is displayed.





3. Type the expression in the box. You can use the Catalogue, if necessary, to insert a function, command, symbol or expression template.
4. To exit the maths box, click anywhere outside it.

### Evaluating and Approximating Maths Expressions

You can evaluate or approximate one or more expressions and display the results. You can also convert selected text and multiple maths expression boxes into a single maths expression box. Notes automatically updates expressions and any variables used.

Menu Name	Menu Option	Function
	<b>1: Actions</b>	
	 1: Evaluate - 	Evaluates the expression.
	 2: Approximate  	Approximates the expression.
	 3: Evaluate and replace	Replaces the selected part of the expression with the result.
	 4: Deactivate	Deactivates the current or selected item (box or boxes)
	 5: Deactivate All	Deactivates all boxes in the current Notes application.

Menu Name	Menu Option	Function
	 6: Activate	Activates the current or selected previously deactivated item.
	  7: Activate All	Activates all boxes in the current Notes application.

### Evaluating or Approximating an Expression

To evaluate or approximate an expression, place the cursor anywhere in the maths expression box and then do the following:

- Windows®: On the **Actions** menu, click **Evaluate** or **Approximate**. You can also use **Enter** to evaluate or **Ctrl + Enter** to approximate.
- Mac®: Press **⌘ + Enter** to approximate.
- Handheld: Press  to display the Notes menu. On the **Actions** menu, select **Evaluate**.

The result replaces the expression.

### Evaluating Part of an Expression

To evaluate part of an expression, select the text or part of the maths expression. Then do the following:

- ▶ On the **Actions** menu, click **Evaluate and Replace**.



Handheld: Press  to open the Notes menu. Select **Actions**, and then select **Evaluate Selection**.

The result replaces the selected part only.

### Breaking Long Calculations

Some calculations may take a long time. Notes indicates that the handheld is performing a long calculation by displaying a busy icon. If a calculation is taking more time than you want to spend, you can end the calculation.

To stop the function or programme in progress, do the following:

- Windows®: Hold down the **F12** key and press **Enter** repeatedly.
- Mac®: Hold down the **F5** key and press **Enter** repeatedly.
- Handheld: Hold down the  key and press  repeatedly.

## Showing Warnings and Errors

If a calculation in Notes results in a warning or error, you can view the warning or error again even after you have dismissed the dialogue box.

To display a warning or error in Notes after you have dismissed the dialogue box, do one of the following:

- Windows®: Right-click and select **Show warning info** or **Show error**.
- Mac®:  $\mathcal{H}$  + click and select **Show warning info** or **Show error**.

**Note:** You can change your settings so that warnings do not appear at all. The showing of warning indicators is controlled by the **Maths Box Attributes** dialogue box. See *Changing the Attributes of Maths Expression Boxes*.

## Converting Selected Items to Maths Expression Boxes

To convert items to maths expression boxes:

1. Select the text, or combination of text and existing maths expression box, that you want to evaluate.
2. From the **Actions** menu, click **Convert to Maths Expression Box**.

## Using Maths Actions

Maths Actions are available on Notes, Scratchpad and Calculator pages.

When you display the context menu for a selected expression or equation, the menu may include a **Maths Actions** submenu that lists the available actions. Each action might prompt you for any needed parameters.

The specific maths actions listed depend on:

- The type of expression or relation.
- The operating system in use (Numeric, Exact Arithmetic, or CAS).
- Any restrictions imposed by an active Press-to-Test session.

## Example of Maths Actions in Notes

1. Insert a maths box, and type the equation  $x^2+3x+1=0$ , but don't press **Enter** yet.

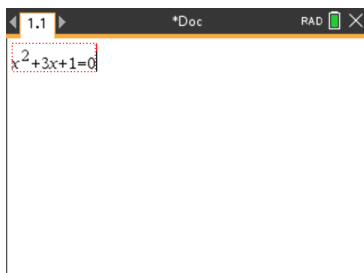

2. Display the context menu of the equation, and select **Maths Actions**.  
 Windows®: Right-click the equation.  
 Mac®: Hold  $\mathcal{H}$ , and click the equation.  
 Handheld: Point to the equation, and press **ctrl** **menu**.

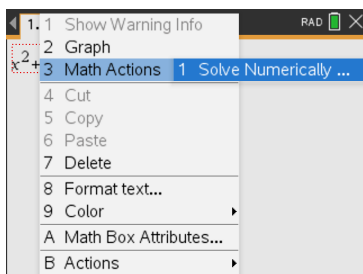

Numeric and Exact Arithmetic OS

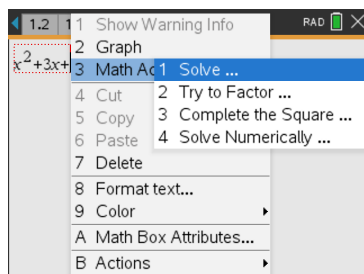

CAS OS

3. Select the action to perform:
  - **Solve Numerically** for Numeric and Exact Arithmetic OS.
  - **Solve** for CAS OS.

You are prompted to enter parameters. For example, Numeric Solve prompts for the variable of interest, initial guess, lower bound and upper bound.

4. Type a value for each parameter. When options are available, you can click an arrow to make a selection.

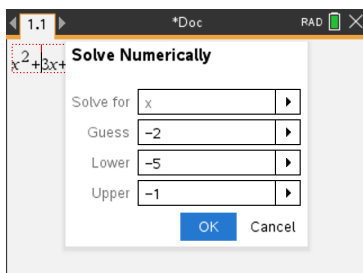

Numeric and Exact Arithmetic OS

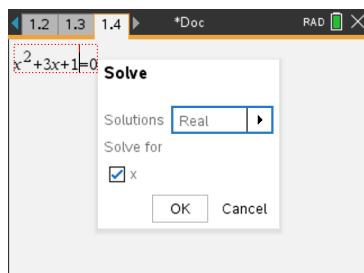

CAS OS

5. Click **OK** to construct the completed expression and place it in the maths box.

$$\text{nSolve}(x^2+3x+1=0,x=-2)|-5\leq x\leq-1$$

Numeric and Exact Arithmetic OS

$$\text{solve}(x^2+3x+1=0,x)$$

CAS OS

6. Press **Enter** to complete the action.

$$\text{nSolve}(x^2+3\cdot x+1=0,x=-2)|-5\leq x\leq-1$$

▶ -2.61803

Numeric and Exact Arithmetic OS

$$\text{solve}(x^2+3\cdot x+1=0,x)$$

▶  $x = \frac{-(\sqrt{5}+3)}{2}$  or  $x = \frac{\sqrt{5}-3}{2}$

CAS OS

7. As a further exploration, drag through the maths box to select  $x^2+3\cdot x+1$ . Do not include the "=0" portion.

$$\text{nSolve}(x^2+3\cdot x+1=0,x=-2)|-5\leq x\leq-1$$

▶ -2.61803 

Numeric and Exact Arithmetic OS

$$\text{solve}(x^2+3\cdot x+1=0,x)$$

▶  $x = \frac{-(\sqrt{5}+3)}{2}$  or  $x = \frac{\sqrt{5}-3}{2}$  

CAS OS

8. Display the context menu for the selected text, select **Maths Actions > Find Roots of Polynomial**, and press **Enter** to complete the action.

The action and its result are shown in a new maths box.

$$\text{polyRoots}(x^2+3\cdot x+1,x)$$

▶  $\{-2.61803, -0.381966\}$

Numeric OS

$$\text{polyRoots}(x^2+3\cdot x+1,x)$$

▶  $\left\{ \frac{-(\sqrt{5}+3)}{2}, \frac{\sqrt{5}-3}{2} \right\}$

Exact Arithmetic and CAS OS

### Tips for Using Maths Actions in Notes

- ▶ For a previously evaluated expression, click in the expression and then display its context menu.

When you select an action, it replaces the expression.

- ▶ For a displayed result, click in the result and then display its context menu.

When you select an action, it appears in a new maths box.

- ▶ For a portion of an expression or result, select the portion and then display the context menu.

When you select an action, it appears in a new maths box.

## Graphing from Notes and Calculator

You can graph a function or relation directly from its context menu. This feature is available for many functions and relations on Notes, Scratchpad and Calculator pages.

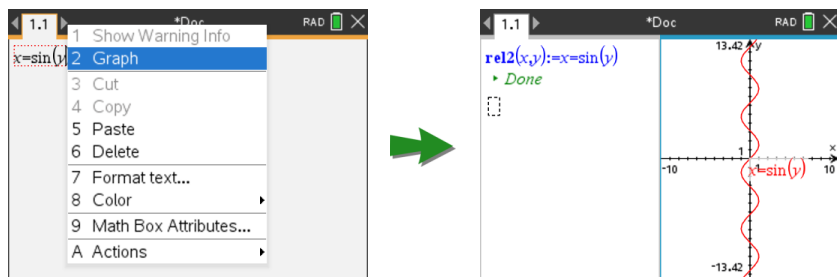

If page layout options allow, the graph appears on the same page as the function or relation. Otherwise, the graph appears on a separate Graphs page.

The type of graph created depends on:

- The type of function or relation.
- Any restrictions imposed by an active Press-to-Test session.

### Example of Graphing from Notes

This example uses a Notes page to explore a quadratic function interactively.

1. Insert a maths box on a new Notes page, and enter the following function definition:

**Define**  $f1(x) = x^2 - 1 \cdot x - 4$

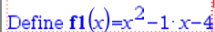
A screenshot of a math box containing the text 'Define f1(x)=x^2-1·x-4'. The text is blue and has a dashed red border around it, indicating it is selected or highlighted.

2. Display the context menu of the Define statement.  
Windows®: Right-click the statement.  
Mac®: Hold  $\mathcal{H}$ , and click the statement.  
Handheld: Point to the statement, and press **ctrl** **menu**.

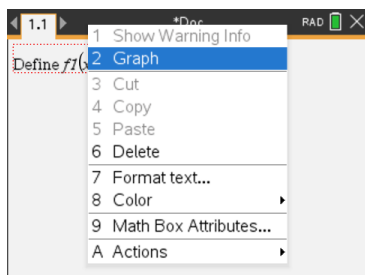



3. Select **Graph** from the context menu.

The graph appears. The graph and the maths box are linked so that any adjustment to one affects the other.

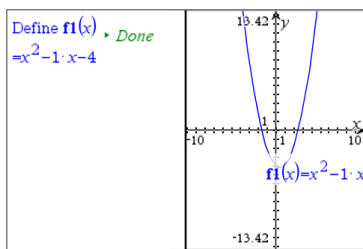

4. Explore the relationship between the defined function and its graph:

- Drag the ends or centre of the graph to manipulate it, and observe the changes to the function definition.

—or—

- Edit the defined function in the maths box, and observe the changes to the graph.

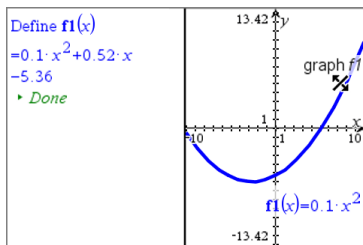

### Inserting Chemical Equations in Notes

Chemical equation boxes (chem boxes) make it easy to type chemical formulas and equations, such as  $\text{CH}_4 + 2\text{O}_2 \rightarrow \text{CO}_2 + 2\text{H}_2\text{O}$ .

As you type in a chem box, most of the formatting work is handled automatically:

- Correct capitalisation of most element symbols, such as Ag and Cl, is automatic.
- Leading digits are treated as coefficients and are shown at full size. Numbers that follow an element or a closed parenthesis are converted to subscripts.
- The equals "=" symbol is converted to a yields "→" symbol.

#### Notes:

- Equations in a chem box cannot be evaluated or balanced.

- Element capitalisation may not work in every situation. For example, to enter carbon dioxide, CO<sub>2</sub>, you must manually capitalise the O. Otherwise, typing “co” would result in “Co”, the symbol for cobalt.

### Entering a chemical equation

1. In the Notes work area, position the cursor where you want the equation.
2. From the **Insert** menu, select **Chem Box**.  
—or—  
Press **Ctrl + E** (Mac®: Press **⌘ + E**).

An empty chemical equation box is displayed.



3. Type the equation in the box. For example, to represent sulphuric acid, type **h2sO4**, capitalising the O manually.

The chem box automatically formats the text as you type:



4. If you need superscripts for ionic equations, type a caret symbol (^) and then the text.



5. Use parentheses to indicate whether a compound is solid (s), liquid (l), gas (g), or aqueous (aq).

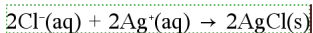

6. To exit the chem box, click anywhere outside it.

### Deactivating Maths Expression Boxes

Calculations are by default activated, which means that results automatically update when you evaluate or approximate an expression. If you don't want results to automatically update, you can deactivate a maths expression box, group of boxes or the entire application.

#### Deactivating a Box or a Group of Boxes

To deactivate a box or a group of boxes:

1. Select the box or boxes that you want to deactivate.
2. Deactivate the selected box or boxes:
  - Windows®: Click **Actions > Deactivate** (or right-click and then click **Actions > Deactivate**).
  - Mac®: Click **Actions > Deactivate** (or **⌘ + click** and then click **Actions > Deactivate**).

- Handheld: Press  to open the Notes menu. From the **Actions** menu, select **Deactivate**.

**Note:** You can manually update a deactivated box or boxes by selecting the box or boxes and using the process described in *Evaluating and Approximating Maths Expressions*.

### Deactivating All Boxes in the Notes Application

To deactivate all boxes in the Notes application:

- ▶ With a document open, place your cursor in the Notes application that you want to deactivate and select **Deactivate All**.
  - Windows®: Click **Actions > Deactivate All** or right-click and click **Actions > Deactivate All**.
  - Mac®: Click **Actions > Deactivate** or  $\mathcal{H}$ + click and click **Actions > Deactivate**.
  - Handheld: Press  to display the Notes menu. On the **Actions** menu, click **Deactivate**.

**Note:** When you use this option in Q&A and Proof templates, Deactivate All deactivates only the maths boxes in the current work area.

### Changing the Attributes of Maths Expression Boxes

You can change attributes in one or more maths expression boxes at the same time. Controlling the attributes in maths expression boxes allows you to do the following:



- Show or hide the input or output or prevent calculation in the box.
- Select a symbol separator using Insert Symbol.
- Choose the number of digits to display in the output of a maths expression.
- Select angle settings so you can use both radian/degree and gradian angle measures in the same Notes application.
- Select whether to allow maths expressions to wrap.
- Select whether to show or hide warning indicators.

To change the attributes of one or more boxes, do the following:

1. Select the box or boxes that you want to change.
2. On the **Maths Box Options** menu, click **Maths Box Attributes**.
3. Use the menus or selection boxes to make your selections.
4. Click **OK** to save or **Cancel** to abandon the change.

**Note:** Maths expression boxes recalculate automatically after you have made attribute changes and saved the changes.

## Undoing Changes to Maths Expression Boxes







► To undo changes you have made to a maths expression box, click  .





## Using Calculations in Notes

In the Notes application, the options on the Calculations menu enable you to perform calculations. The calculations are described in the following table.

### Important Information to Know

- Notes does not support editing programmes. Use Programme Editor instead.
- Notes does not support executing Lock or Unlock commands. Use Calculator instead.
- Notes does not display intermediate results obtained via "Disp" command. Use Calculator instead.
- Notes does not support user-defined dialogue boxes obtained via "Request," "RequestStr," or "Text" commands. Use Calculator instead.
- Notes does not support the execution of multiple statistics commands that produce stat. variables.

Menu Name	Menu Option	Function
 <b>6: Calculations</b>		
	 1: Define Variables	Define a variable in a Note using the Calculator application.
	 2: Number	Use tools from the Calculator Number menu, including Convert to Decimal, Approximate to Fraction, Factorise, Least Common Multiple, Highest Common Factor, Remainder, Fraction Tools, Number Tools and Complex-Number Tools.
	 3: Algebra	Use tools from the Calculator Algebra menu, including Numerical Solve, Solve System of Linear Equations, Polynomial Tools.
	 4: Calculus	Use tools from the Calculus menu including Numerical Derivative at a Point, Numerical Definite Integral, Sum, Product, Numerical Function Minimum and Numerical Function Maximum.
	 3 (CAS): Algebra	Use tools from the Calculator Algebra menu, including Solve, Factorise, Expand, Zeroes, Numerical Solve, Solve System of Equations, Polynomial Tools, Fraction Tools, Convert Expressions, Trigonometry, Complex and Extract.
	 4 (CAS): Calculus	Use tools from the Calculus menu including Derivative, Derivative at a Point, Integral, Limit, Sum, Product,

Menu Name	Menu Option	Function
		Function Minimum, Function Maximum, Tangent Line, Normal Line, Arc Length, Series, Differential Equation Solver, Implicit Differentiation and Numerical Calculations
	 5: Probability	Use tools from the Calculator Probability menu, including Factorial, Permutations, Combinations, Random and Distributions.
	 6: Statistics	Use tools from the Calculator Statistics menu, including Stats Calculations, Stats Results, List Maths, List Operations and others.
	 7: Matrix & Vector	Use tools from the Calculator Matrix & Vector menu, including Create, Transpose, Determinant, Row-Echelon Form, Reduced Row-Echelon Form, Simultaneous, and others.
	 8: Finance	Use tools from the Calculator Finance menu, including Finance Solver, TVM Functions, Amortization, Cash Flows, Interest Conversions and Days between Dates.
<b>Note:</b> For more information, see the <i>Calculator</i> documentation.		

## Exploring Notes with Examples

This section shows you how the Notes application works with other applications to automatically update results.

### Example #1: Using Notes to Explore Roots of a Quadratic Function

1. Open a new document and start the Notes application.
2. Define a function in a maths box, evaluate, and hide the output using the Maths Box attributes.

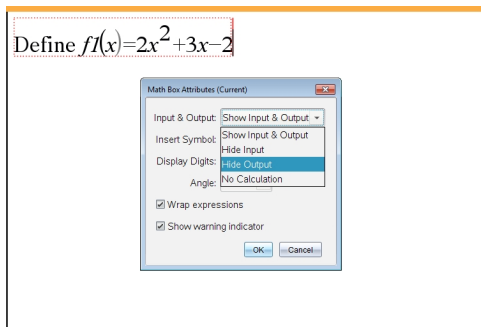

3. Type some more text; for example: “Real Roots of f1(x) are:”
4. In a new maths box, type: polyRoots(f1(x),x).

- Press **enter** and hide the input of this maths box by using the Maths Box attributes dialogue box.
- Use the Page Layout toolbar icon to select the split layout.

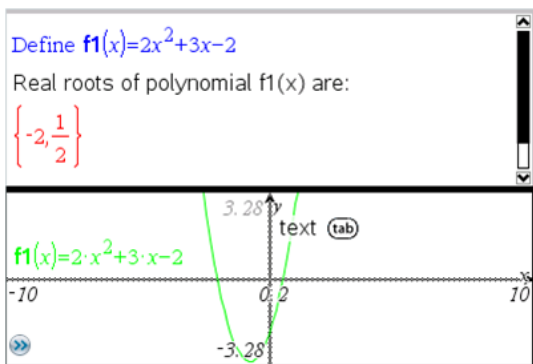

- Add the Graph application and plot  $f_1(x)$ .

See how the roots of  $f_1$  change when the function is modified in Graph.

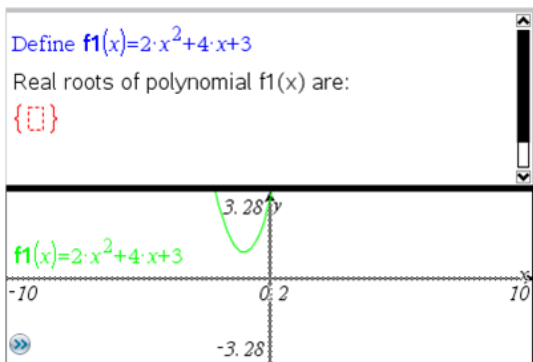

### Example #2: Using Notes to Explore Data Sampling

In this example, we create a sampling distribution of sample means drawn from a given population. We will be able to watch the sampling distribution take shape for a given sample size and describe its characteristics. You can change the population and the sample size.

- Set up the population and the sample size.
  - Type "Create sample data:"
  - Insert a maths expression box and define the population. For example, type "population:=seq(n,n,1,50)".

- c) Press **enter** and hide the output using the Maths Expression Box Attributes dialogue box.
  - d) Insert a maths expression box and define the sample size. For example, type "size:=5".
  - e) Press **enter** and hide the output using the Maths Expression Box Attributes dialogue box.
2. Set up the initialization.
- a) Type "Start taking samples:"
  - b) Insert a maths expression box and set the initial values for the number of samples (num) and the list of sample means (sampmeans). Type:  
"num:=0:sampmeans:={}"
  - c) Press **enter** and hide the output using the Maths Expression Box Attributes dialogue box.
  - d) Deactivate the maths expression box using **Actions > Deactivate**. The deactivation will prevent the content of that maths box from being overwritten when the values for num and sampmeans change. The deactivated maths box will be shown with the light colour background.
3. Set up Data & Statistics for the sampling.
- a) Change the page layout and insert Data & Statistics.
  - b) Click on the horizontal axis and add sampmeans list.
  - c) Change the window setting: XMins=1 and XMax = 50.
  - d) You can also set up the plot of the mean of sample means using **Analyse > Plot Value**.

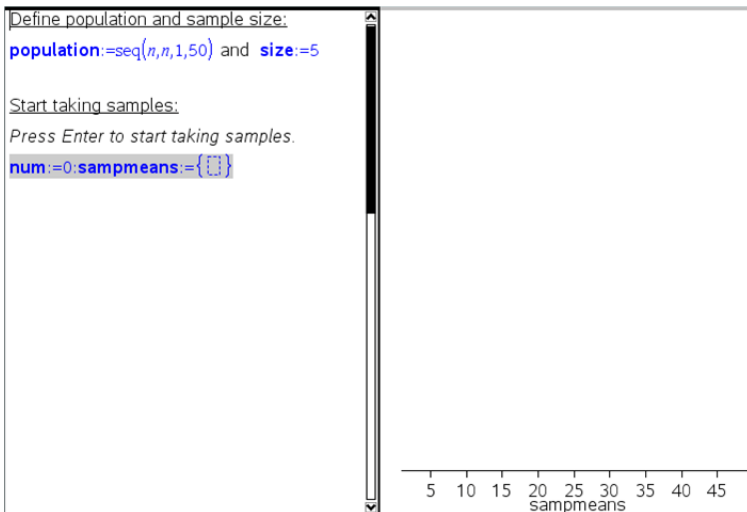

4. Enter the instructions to add data.

- Type "Create new samples:"
- Insert a maths expression to define the sample (sample) and update the number of samples and the list of sample means. Type:

```
"num:=num+1:sample:=randsamp(population,size):  
sampmeans:=augment(sampmeans,{mean(sample)})"
```

- Press **enter**, hide the output, and turn off the expression wrapping using the Maths Expression Box Attributes dialogue box.
- Deactivate the maths expression box using **Actions > Deactivate** to prevent the content of the maths box to be overwritten when num and sampmeans values are reinitialized.
- Create maths expression boxes that display the current number of experiments (num), sample (sample) and the list of sample means (sampmeans).

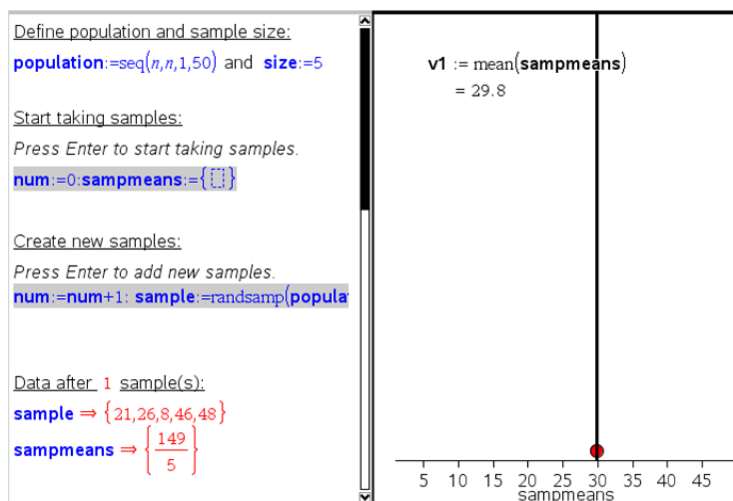

5. Now you are ready to explore. Add more samples by simply pressing **enter** when you are in the maths expression box in the "Create new samples" section.

**Note:** You can also automate the sampling process by using a **For ... EndFor** loop.



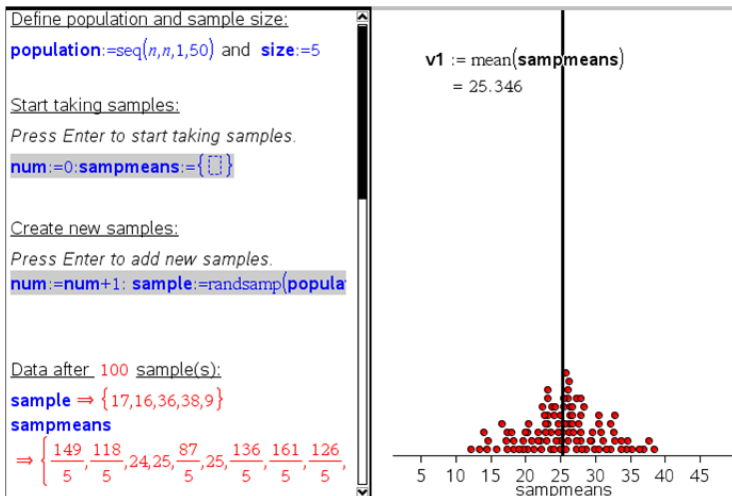

You can also change the sample size and restart the sampling.

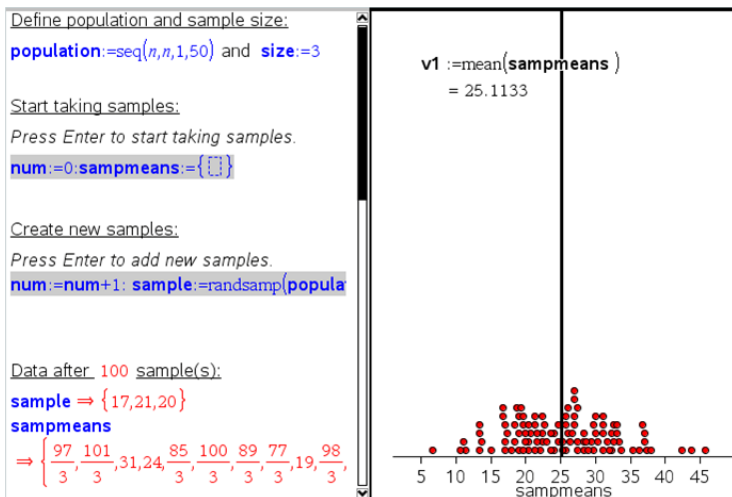

# Data Collection

The Vernier DataQuest™ application is built into the TI-Nspire™ software and the operating system (OS) for handhelds. The application lets you:

- Capture, view, and analyse real-world data using a TI-Nspire™ CX II handheld, a Windows® computer, or a Mac® computer.
- Collect data from up to five connected sensors (three analogue and two digital) using the TI-Nspire™ Lab Cradle.

**Important:** The TI-Nspire™ CM-C Handheld is not compatible with the Lab Cradle and only supports the use of a single sensor at a time.

- Collect data either in the classroom or at remote locations using collection modes such as time-based or event-based.
- Collect several data runs for comparison.
- Create a graphical hypothesis using the Draw Prediction feature.
- Play back the data set to compare the outcome to the hypothesis.
- Analyse data using functions such as interpolation, tangential rate or modelling.
- Send collected data to other TI-Nspire™ applications.
- Access sensor data from all connected sensor probes through your TI-Basic program.

## Adding a Vernier DataQuest™ Page

**Note:** The application is launched automatically when you connect a sensor.

Starting a new document or problem for each new experiment ensures that the Vernier DataQuest™ application is set to its default values.

- ▶ To start a new document containing a data collection page:

From the main **File** menu, click **New Document**, and then click **Add Vernier DataQuest™**.





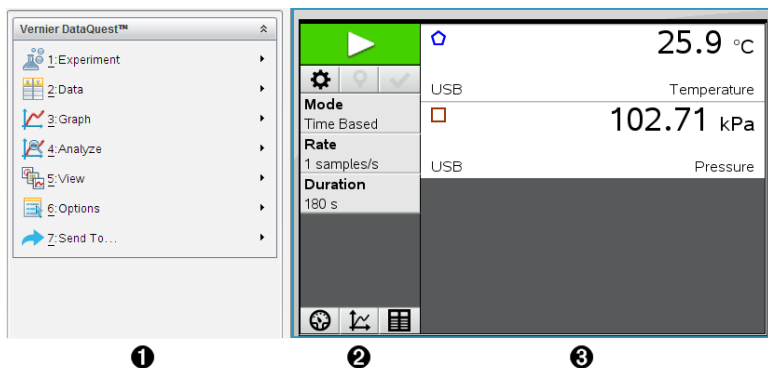

Handheld: Press  **on**, and select **Vernier DataQuest™** .

- ▶ To insert a new problem with a data collection page into an existing document:

From the toolbar, click **Insert > Problem>Vernier DataQuest™**.

Handheld: Press  and select **Insert > Problem > Vernier DataQuest™**.



- ❶ **Vernier DataQuest™ Menu.** Contains menu items for set-up, collection and analysis of sensor data.
- ❷ **Details view.** Contains buttons for starting data collection , changing collection settings , marking collected data , storing data sets , and tabs for managing multiple data runs.  
View selection buttons let you choose from Meter view , Graph view , or Table view .
- ❸ **Data work area.** The information displayed here depends on the view.
  - Meter.** Displays a list of sensors that are currently connected or set up in advance.
  - Graph.** Displays collected data in a graphical representation, or displays the prediction before a data collection run.
  - Table.** Displays collected data in columns and rows.

## What You Must Know

### Basic Steps in Performing an Experiment

These basic steps are the same no matter which type of experiment you perform.

1. Start the Vernier DataQuest™ Application.
2. Connect sensors.
3. Modify sensor settings.
4. Select the collection mode and collection parameters.
5. Collect data.
6. Stop collecting data.
7. Store the data set.
8. Save the document to save all data sets in the experiment.
9. Analyse the data.

## Sending Collected Data to Other TI-Nspire™ Applications

You can send collected data to the Graphs, Lists & Spreadsheet, and Data & Statistics applications.

- ▶ From the **Send To** menu, click the name of the application.

A new page showing the data is added to the current problem.

## About Collection Devices

You can select from a variety of sensors and interfaces to collect data while running the Vernier DataQuest™ application with TI-Nspire™ software.

### Multi-Channel Sensor Interfaces

Multi-channel sensor interfaces let you connect more than one sensor at a time.

Sensor Interface	Description
	<p>This sensor can be used with a handheld, a computer, or as a stand-alone sensor.</p> <p>The sensor interface allows you to connect and use one to five sensors at the same time. It can be used in the lab or at a remote collection location.</p> <p>The Lab Cradle supports two digital sensors and three analogue sensors.</p> <p>The Lab Cradle also supports high-sample data collection sensors, such as a hand-grip heart rate or a blood pressure monitor.</p> <p>After using the Lab Cradle as a remote sensor, you can download data to either a handheld or computer.</p>

Texas Instruments TI-Nspire™ Lab Cradle

### Single-Channel Sensor Interfaces

Single-channel sensor interfaces can only connect to one sensor at a time. These sensors have either a mini-USB connector for a handheld or a standard USB connector for a computer. For a complete list of compatible sensors, see *Compatible Sensors*.

Sensor Interface	Description
	<p>This sensor interface is used with handhelds. It has a mini-USB connector so it can be plugged directly into the handheld.</p> <p>Connect sensors to Vernier EasyLink® to:</p> <ul style="list-style-type: none"><li>• Measure barometric pressure.</li></ul>

Sensor Interface	Description
Vernier EasyLink®	<ul style="list-style-type: none"> <li>• Measure the salinity of a solution.</li> <li>• Investigate the relationship between pressure and volume (Boyles' Law).</li> </ul>
 <p>Vernier GoLink®</p>	<p>This sensor interface is used with computers. It has a standard connector so it can be plugged into a Windows® or Mac® computer.</p> <p>Connect sensors to Vernier GoLink® to:</p> <ul style="list-style-type: none"> <li>• Measure the acidity or alkalinity of a solution.</li> <li>• Monitor greenhouse gases.</li> <li>• Measure sound level in decibels.</li> </ul>

### Types of Sensors

- **Analogue sensors.** Temperature, light, pH and voltage sensors are analogue sensors and require a sensor interface.
- **Digital sensors.** Photogates, radiation monitors and drop counters are digital sensors. These sensors can only be used with the TI-Nspire™ Lab Cradle.
- **Direct-connect USB sensors.** These sensors connect directly to a handheld or computer and do not require a sensor interface.

### Sensors for Handhelds



The following lists some sensors you can use with a handheld.

Sensor	Description
 <p>Texas Instruments CBR 2™</p>	<p>This analogue sensor connects directly to TI-Nspire™ CX II handhelds through the mini-USB port. It is used to explore and graph motion.</p> <p>This sensor automatically launches the Vernier DataQuest™ application when you connect it to a handheld. Data collection begins when you select the Motion Match function.</p> <p>This sensor collects up to 200 samples per second.</p> <p>Use this sensor to:</p> <ul style="list-style-type: none"> <li>• Measure position and speed of a person or object.</li> <li>• Measure the acceleration of an object.</li> </ul>

Sensor	Description
 <p><b>Vernier EasyTemp® temperature sensor</b></p>	<p>This analogue sensor connects directly to TI-Nspire™ CX II handhelds through the mini-USB port and is used to collect temperature ranges. You can design experiments to:</p> <ul style="list-style-type: none"> <li>• Collect weather data.</li> <li>• Record temperature changes due to chemical reactions.</li> <li>• Perform heat fusion studies.</li> </ul>

## Sensors for Computers

The following table lists some sensors you can use with a computer.

Sensor	Description
 <p><b>Vernier GoTemp® temperature sensor</b></p>	<p>This analogue sensor connects to the computer's USB port and is used to collect temperature ranges. You can use this sensor to:</p> <ul style="list-style-type: none"> <li>• Collect weather data.</li> <li>• Record temperature changes due to chemical reactions.</li> <li>• Perform heat fusion studies.</li> </ul>
 <p><b>Vernier Go!Motion® motion detector</b></p>	<p>This analogue sensor connects to the computer's USB port and is used to measure acceleration, speed and velocity. Use this sensor to:</p> <ul style="list-style-type: none"> <li>• Measure position and speed of a person or object.</li> <li>• Measure the acceleration of an object.</li> </ul>

## Compatible Sensors

The following sensors can be used with the Vernier DataQuest™ application.

- 25-g Accelerometer
- 30-Volt Voltage Probe
- 3-Axis Accelerometer

- Low-g Accelerometer
- CBR 2™ - Connects directly to handheld USB port
- Go!Motion® - Connects directly to computer USB port
- Extra Long Temperature Probe
- Stainless Steel Temperature Probe
- Surface Temperature Sensor
- Ammonium Ion-Selective Electrode
- Anemometer
- Barometer
- Blood Pressure Sensor
- CO2 Gas Sensor
- Calcium Ion-Selective Electrode
- Charge Sensor
- Chloride Ion-Selective Electrode
- Colorimeter
- Conductivity Probe
- High Current Sensor
- Current Probe
- Differential Voltage Probe
- Digital Radiation Monitor
- Dissolved Oxygen Sensor
- Dual-Range Force Sensor
- EasyTemp® - Connects directly to handheld USB port
- EKG Sensor
- Electrode Amplifier
- Flow Rate Sensor
- Force Plate
- Gas Pressure Sensor
- Go!Temp® - Connects directly to computer USB port
- Hand Dynamometer
- Hand-Grip Heart Rate Monitor
- Instrumentation Amplifier
- Light Sensor
- Magnetic Field Sensor
- Melt Station

- Microphone
- Nitrate Ion-Selective Electrode
- O<sub>2</sub> Gas Sensor
- ORP Sensor
- pH Sensor
- Relative Humidity Sensor
- Respiration Monitor Belt (Requires Gas Pressure Sensor)
- Rotary Motion Sensor
- Salinity Sensor
- Soil Moisture Sensor
- Sound Level Meter
- Spirometer
- Thermocouple
- TI-Light - Sold only with the CBL 2™
- TI-Temp - Sold only with the CBL 2™
- TI-Voltage - Sold only with the CBL 2™
- Tris-Compatible Flat pH Sensor
- Turbidity Sensor
- UVA Sensor
- UVB Sensor
- Vernier Constant Current System
- Vernier Drop Counter
- Vernier Infrared Thermometer
- Vernier Motion Detector
- Vernier Photogate
- Voltage Probe
- Wide-Range Temperature Probe

### ***Connecting Sensors***

Direct-connect USB sensors, such as the Vernier Go!Temp® temperature sensor (for computers) or the Vernier EasyLink® temperature sensor (for handhelds), connect directly to the computer or handheld and do not need a sensor interface.

Other sensors require a sensor interface such as the TI-Nspire™ Lab Cradle.



## Connecting Directly

- ▶ Attach the cable on the sensor directly to the computer's USB port or to an appropriate port on the handheld.

## Connecting through a Sensor Interface

1. Attach the sensor to the sensor interface using either the mini-USB, USB or BT connector and the appropriate cable.
2. Attach the interface to a computer or handheld using the appropriate connector and cable.

**Note:** To attach a handheld to a TI-Nspire™ Lab Cradle, slide the handheld into the connector at the bottom of the Lab Cradle.

## Setting Up an Offline Sensor

You can pre-define meter settings for a sensor that is not currently attached to a computer or handheld.

You cannot use the sensor offline, but you can prepare the experiment for it and then attach it when ready to collect the data. This option makes it faster to share a sensor during a lesson or lab in which there are not enough sensors for everyone.

1. From the **Experiment** menu, select **Advanced Set Up > Configure Sensor > Add Offline Sensor**.

The Select Sensor dialogue box opens.

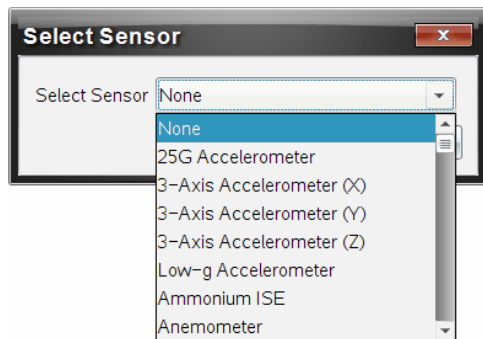

2. Select a sensor from the list.
3. Click the **Meter View** tab .
4. Click the sensor you have added, and [modify its settings](#).

The settings will be applied when you attach the sensor.

## Removing an offline sensor

1. From the **Experiment** menu, select **Advanced Setup > Configure Sensor**.
2. Select the name of the offline sensor to remove.

3. Click **Remove**.

## Modifying Sensor Settings

You can modify how the sensor values are displayed and stored. For example, when using a temperature sensor, you can change the unit of measure from Centigrade to Fahrenheit.

### Changing Sensor Measurement Units

Measurement units depend on the selected sensor. For example, units for the Vernier Go!Temp® Temperature sensor are Fahrenheit, Celsius and Kelvin. Units for the Vernier Hand Dynamometer (a specialised force sensor) are Newton, Pound and Kilogramme.

You can change the units before or after you collect data. The collected data reflects the new measurement unit.

1. Click Meter view  to display the connected and offline sensors.
2. Click the sensor whose units you want to change.
3. In the Meter Settings dialogue box, select the unit type from the **Measurement Units** menu.

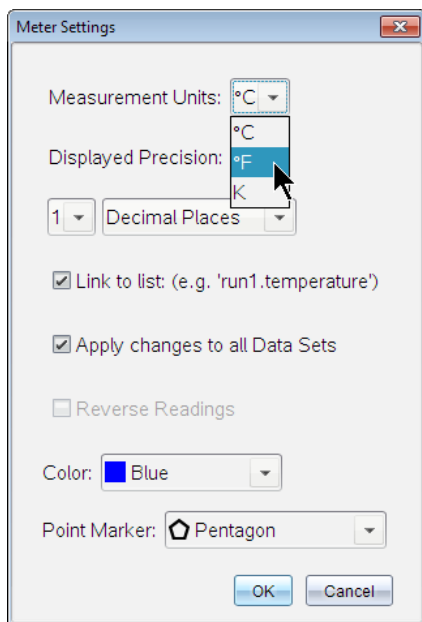

## Calibrating a Sensor

When the software or handheld detects a sensor, the calibration for that sensor automatically loads. You can calibrate some sensors manually. Other sensors, such as the Colorimeter and the Dissolved Oxygen Sensor, must be calibrated to provide useful data.

There are three options for calibrating a sensor:

- Manual Entry
- Two Point
- Single Point

Refer to the sensor's documentation for specific calibration values and procedures.

## Setting a Sensor to Zero

You can set the standing value of some sensors to zero. You cannot set sensors in which relative measurements such as force, motion and pressure are common to zero. Sensors designed to measure specific environmental conditions, such as Temperature, pH and CO<sub>2</sub> also cannot be set to zero.

1. Click Meter view  to display the connected and offline sensors.
2. Click the sensor that you want to set to zero.
3. In the Meter Settings dialogue box, click **Zero**.

## Reversing a Sensor's Readings

By default, pulling with a force sensor produces a positive force and pushing produces a negative force. Reversing the sensor allows you to display pushing as a positive force.

1. Click Meter view  to display the connected and offline sensors.
2. Click the sensor that you want to reverse.
3. In the Meter Settings dialogue box, click **Reverse Readings**.

The sensor display is now reversed. In Meter View, the reverse indicator  appears after the sensor name.

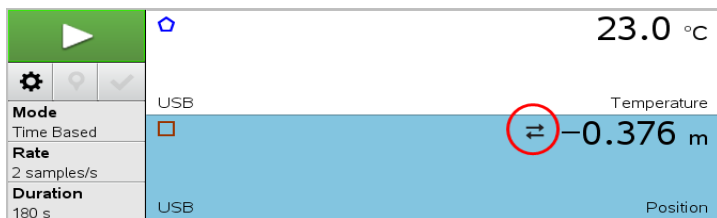

## Collecting Data

### Collecting Time-Based Data

The Time Based collection mode captures sensor data automatically at regular time intervals.

1. Connect the sensor or sensors.

Sensor names are added to the sensor list automatically.

2. From the **Experiment** menu, select **New Experiment**.

This removes all data and restores all meter settings to their defaults.

3. From the **Experiment** menu, select **Collection Mode > Time Based**.

- a) Select **Rate** or **Interval** from the drop-down list, and then type the **Rate** (samples/second) or **Interval** (seconds/sample).

- b) Type the **Duration** of the collection.

The Number of points is calculated and displayed, based on rate and duration. Note that collecting too many data points can slow system performance.

- c) Select **Strip Chart** if you want to collect samples continuously, retaining only the last  $n$  samples. (where " $n$ " is the number shown in the Number of points field.)

4. [Modify sensor settings](#) as necessary.

5. Click **Start Collection** .

6. After the data has been collected, click **Stop Collection** .

The data set run is complete.

### Collecting Selected Events

Use the Selected Events collection mode to capture samples manually. In this mode, each sample is automatically assigned an event number.

1. Connect the sensor or sensors.

Sensor names are added to the sensor list automatically.

2. From the **Experiment** menu, select **New Experiment**.

This removes all data and restores all meter settings to their defaults.

3. From the **Experiment** menu, select **Collection Mode > Selected Events**.

The Selected Events Set-up dialogue box opens.

- **Name.** This text is visible in the Meter View. Its first letter is displayed as the independent variable in the Graph view.
- **Units.** This text is displayed in Graph view alongside the Name.
- **Average over 10 s.** This option averages ten seconds of data for each point.

4. [Modify sensor settings](#) as necessary.

5. Click **Start Collection** .

The Keep Current Reading icon  becomes active. The current sensor value appears in the centre of the graph.

6. Click **Keep Current Reading**  to capture each sample.

The data point is plotted, and the current sensor value appears in the centre of the graph.

**Note:** If you selected the Averaging option, a countdown timer appears. When the counter reaches zero, the system plots the average.

7. Continue capturing until you collect all of the desired data points.

8. Click **Stop Collection** .

The data set run is complete.

### Collecting Events with Entry

Use the Events with Entry collection mode to capture samples manually. In this mode, you define the independent value for each point you collect.

1. Connect the sensor or sensors.

Sensor names are added to the sensor list automatically.

2. From the **Experiment** menu, select **New Experiment**.

This removes all data and restores all meter settings to their defaults.

- From the **Experiment** menu, select **Collection Mode > Events with Entry**.

The Events with Entry Set-up dialogue box opens.

- **Name.** This text is visible in the Meter View. Its first letter is displayed as the independent variable in the Graph view.
- **Units.** This text is displayed in Graph view alongside the Name.
- **Average over 10 s.** This option averages ten seconds of data for each point.

- [Modify sensor settings](#) as necessary.

- Click **Start Collection** .

The Keep Current Reading icon  becomes active. The current sensor value appears in the centre of the graph.

- Click **Keep Current Reading**  to capture a sample.

The Events with Entry dialogue box opens.

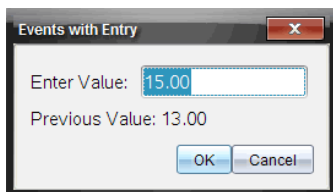

- Type a value for the independent variable.
- Click **OK**.

The data point is plotted, and the current sensor value appears in the centre of the graph.

**Note:** If you selected the Averaging option, a countdown timer appears. When the counter reaches zero, the system plots the average.

- Repeat steps 6 to 8 until you collect all of the desired data points.
- Click **Stop Collection** .

The data set run is complete.

## Collecting Photogate Timing Data

The Photogate Timing collection mode is available only when using the Vernier Photogate sensor. This sensor can time objects that pass through the gates or objects that pass outside of the gates.

1. Connect the Photogate sensor or sensors.

Sensor names are added to the sensor list automatically.

2. From the **Experiment** menu, select **New Experiment**.

This removes all data and restores all meter settings to their defaults.

3. From the **Experiment** menu, select **Collection Mode > Photogate Timing**.

4. Set the collection options.

5. [Modify sensor settings](#) as necessary.

6. Click **Start Collection** .

7. After the data has been collected, click **Stop Collection** .

The data set run is complete.

## Collecting Drop Counter Data

The Drop Counting collection mode is available only when using the Vernier Drop Counter optical sensor. This sensor can count the number of drops or record the amount of liquid added during an experiment.

1. Connect the Drop Counter sensor or sensors.

Sensor names are added to the sensor list automatically.

2. From the **Experiment** menu, select **New Experiment**.

This removes all data and restores all meter settings to their defaults.

3. From the **Experiment** menu, select **Collection Mode > Drop Counting**.

4. Set the collection options.

5. [Modify sensor settings](#) as necessary.

6. Click **Start Collection** .

7. After the data has been collected, click **Stop Collection** .

The data set run is complete.

## Using Data Markers to Annotate Data

Data markers give you a way to emphasise specific data points, such as when you change a condition. For example, you might mark a point at which a chemical is added to a solution or when heat is applied or removed. You can add a marker with or without a comment, and you can hide a comment.

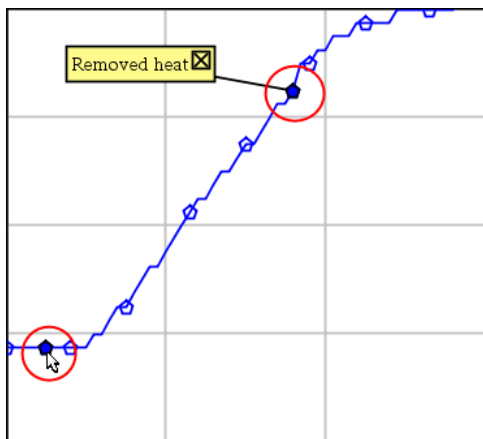

Two data markers, one with a comment displayed

4	1.0	28.4
5	2.0	28.4
6	2.5	28.4
7	3.0	28.4
8	3.5	28.4
9	4.0	28.4
10	4.5	28.4
11	5.0	28.4
12	5.5	28.5

Marker shown as red triangle in Table view

### Adding a Marker During Data Collection

- ▶ Click **Add Data Marker**  to place a marker at the current data point.

### Adding a Marker After Collecting Data

1. In Graph or Table view, click the point at which you want a marker.
2. Click **Add Data Marker** .



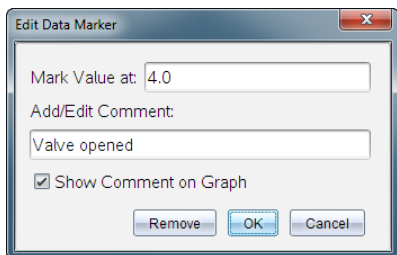

3. Complete the items in the dialogue box.

### Adding a Comment to an Existing Marker

1. In the Detail view, click to expand the list of markers for the data set.

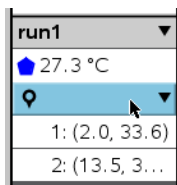

2. Click the entry for the marker that you want to change, and complete the items in the dialogue box.

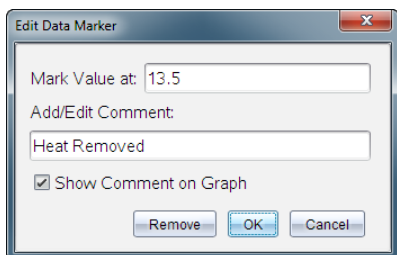

### Repositioning a Data Marker

1. Click to expand the list of markers in the Detail view.

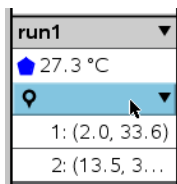

2. Click the entry for the marker that you want to change.
3. In the dialogue box, type a new value for **Mark Value at**.

### Moving a Data Marker's Comment in the Graph View

- ▶ Drag the comment to move it. The connecting line remains attached to the data point.

### Hiding/Showing a Data Marker's Comment

- ▶ Hide a comment by clicking the **X** at the end of the comment.
- ▶ To restore a hidden comment:

- a) Click to expand the list of markers in the Detail view.

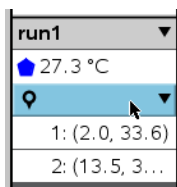

- b) Click the entry for the marker that you want to change, and tick **Show Comment on Graph**.

### Removing a Data Marker

1. Click to expand the list of markers in the Detail view.

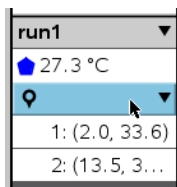

2. In the dialogue box, click **Remove**.

### Collecting Data Using a Remote Collection Unit

To collect information from a sensor while it is disconnected, you can set it up as a remote sensor. Only the TI-Nspire™ Lab Cradle, TI CBR 2™, and Vernier Go!Motion® support remote data collection.

You can set up a remote collection unit to start collecting:

- When you press a manual trigger on the unit, as on the TI-Nspire™ Lab Cradle
- When a delay countdown expires on a unit that supports a delayed start

## Setting Up for Remote Collection

1. Save and close any open documents, and start with a new document.
2. Connect the remote collection unit to the computer or handheld.
3. [Modify the sensor settings.](#)
4. Click the Collection Setup button .
5. On the Collection Setup screen, click **Enable Remote Collection**.
6. Select the remote collection unit from the **Devices** list.
7. Specify the method for starting the collection:
  - To start automatically after a specified delay (on supported units), type the delay value.
  - To start when you press the manual trigger (on supported units), type a delay value of **0**. When you use a delay, the manual trigger button on the TI-Nspire™ Lab Cradle has no effect on the start of the collection.

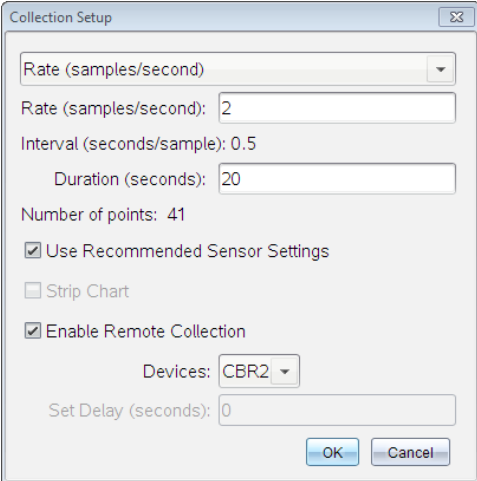

Collection Setup

Rate (samples/second) ▼

Rate (samples/second): 2

Interval (seconds/sample): 0.5

Duration (seconds): 20

Number of points: 41

Use Recommended Sensor Settings

Strip Chart

Enable Remote Collection

Devices: CBR2 ▼

Set Delay (seconds): 0

OK Cancel

8. Click **OK**.

A message confirms that the unit is ready.

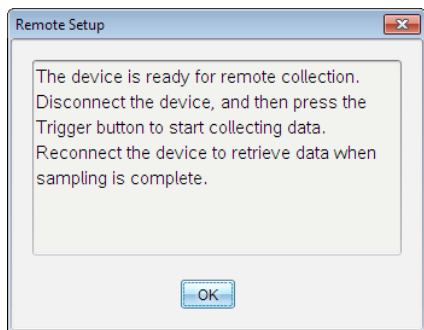

9. Disconnect the unit.

Depending on the device, LED lights may indicate its status.

**Red.** The system is not ready.

**Amber.** The system is ready but not collecting data.

**Green.** The system is collecting data.

10. If you are starting collection manually, press the trigger when ready. If you are starting based on a delay, the collection will start automatically when the countdown is complete.

### Retrieving the Remote Data

After collecting data remotely, you transfer it to the computer or handheld for analysis.

1. Open the Vernier DataQuest™ application.
2. Attach the TI-Nspire™ Lab Cradle to the handheld or computer.

The Remote Data Detected dialogue box opens.

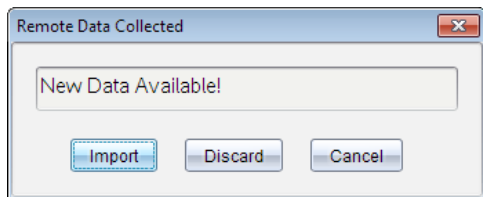

3. Click **Import**.

The data transfers to the Vernier DataQuest™ application.

### Setting Up the Sensor for Triggering

To start data collection based on a specific sensor reading, the TI-Nspire™ Lab Cradle and sensor must be connected.

1. Connect the sensor.

2. Click **Experiment > Advanced Set up > Triggering > Set Up**.

The Configure Trigger dialogue box opens.

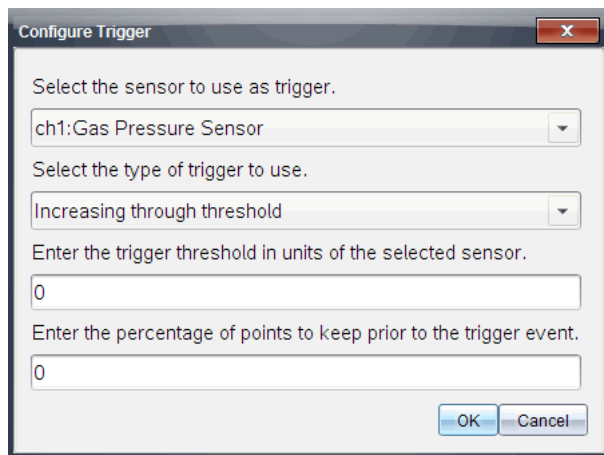

3. Select the sensor from the **Select the sensor to use as trigger** drop-down list.  
**Note:** The menu displays the sensors connected to the TI-Nspire™ Lab Cradle.
4. Select one of the following from the **Select the type of trigger to use** drop-down list.
  - **Increasing through threshold.** Use to trigger on increasing values.
  - **Decreasing through threshold.** Use to trigger on decreasing values.
5. Type the appropriate value in the **Enter the trigger threshold in units of the selected sensor** field.

When entering the trigger value, enter a value within the range of the sensor.

If you change the unit type after setting the threshold, the value automatically updates.

For example, if you use the Vernier Gas Pressure sensor with the units set as atm and you later change the units to kPa, the settings are updated.

6. Type the number of data points to keep before the trigger value occurs.
7. Click **OK**.

The trigger is now set and enabled if values were entered.

8. (Optional) Select **Experiment > Advanced Set up > Triggering** to verify the active indicator is set to Enabled.

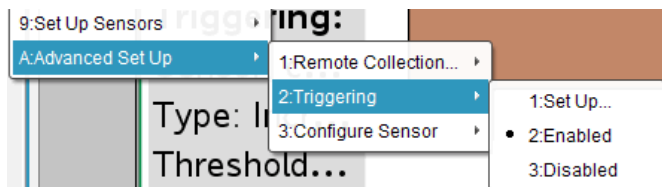

**Important:** When the trigger is enabled, it stays active until it is disabled or you start a new experiment.

### Enabling a Disabled Trigger

If you set the trigger values in the current experiment, and then disable them, you can enable the triggers again.

To enable a trigger:

- ▶ Click **Experiment > Advanced Set Up > Triggering > Enable**.

### Disabling an Enabled Trigger

To disable the active trigger.

- ▶ Click **Experiment > Advanced Set Up > Triggering > Disable**.

## Collecting and Managing Data Sets

By default, the **Start Collection** button  overwrites collected data with data from the next run. To preserve each run, you can store it as a data set. After collecting multiple data sets, you can superimpose any combination of them on the Graph View.

**Important:** Stored data sets are lost if you close the document without saving it. If you want stored data to be available later, make sure to save the document.

### Storing Data as Sets

1. Collect the data from the first run. (See [Collecting Data](#).)
2. Click the **Store Data Set** button .



The data is stored as **run1**. A new data set, **run2**, is created for collecting the next run.

3. Click **Start Collection**  to collect data for **run2**.

## Comparing Data Sets

1. Click the **Graph View** icon  to show the graph.
2. Click the Data Set Selector (near the top of the Detail View) to expand the list of data sets.

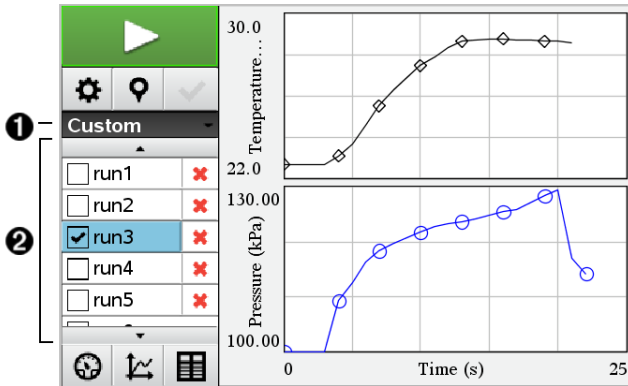

- 1 Data Set Selector lets you expand or collapse the list.
  - 2 Expanded list shows available data sets. Scroll buttons appear as necessary to let you scroll the list.
3. Choose which data sets to view by selecting or clearing the tickboxes.

The graph is rescaled as necessary to show all selected data.

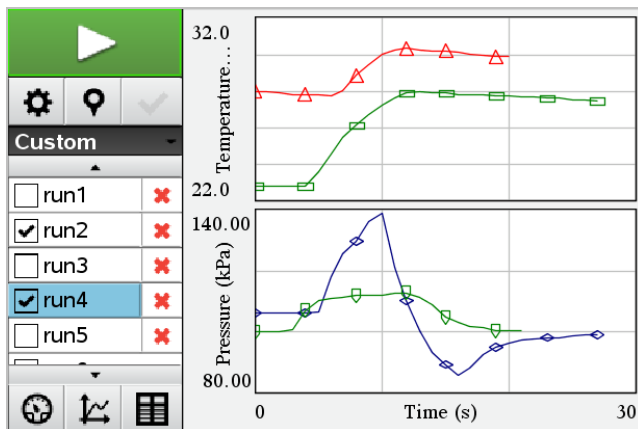

**Tip:** To quickly select a single data set, hold down **Shift** while clicking its name in the list. The graph shows only the selected set, and the list is collapsed automatically to help you view details of the data.

### Renaming a Data Set

By default, data sets are named **run1**, **run2** and so on. The name of each data set is displayed in the Table view.

1. Click the **Table View** icon  to show the table.
2. Display the context menu for the table view, and select **Data Set Options** > [*current name*].

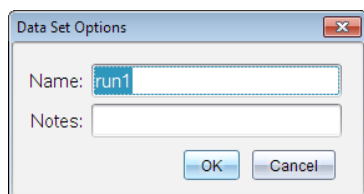

3. Type the new **Name**.

**Note:** The maximum character limit is 30. The name cannot contain commas.

4. (Optional) Type **Notes** about the data.

### Deleting a Data Set

1. Click the **Graph View** icon  to show the graph.
2. Click the Data Set Selector (near the top of the Detail View) to expand the list of data sets.
3. Scroll the list as necessary, and then click the Delete symbol (**X**) next to the name of the data set.

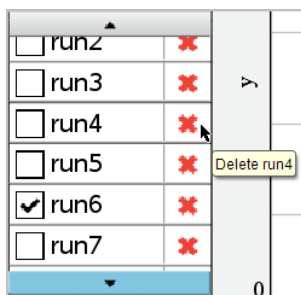



- Click **OK** on the confirmation message.

### Expanding the View Details Area

- ▶ Drag the boundary at the right edge of the Details area to increase or decrease its width.

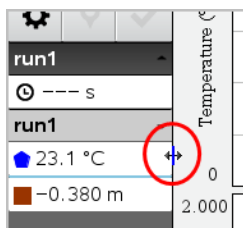

### Using Sensor Data in Programmes

You can access sensor data from all connected sensor probes through your TI-Basic programme by using this command:

*RefreshProbeVars statusVar*

- You must first launch the Vernier DataQuest™ application, or you will receive an error. 

**Note:** The Vernier DataQuest™ application will auto-launch when you connect a sensor or a lab cradle to the TI-Nspire™ software or handheld.

- The *RefreshProbeVars* command will be valid only when Vernier DataQuest™ is in 'meter' mode. 
- statusVar* is an optional parameter that indicates the status of the command. These are the *statusVar* values:

StatusVar Value	Status
<i>statusVar</i> =0	Normal (continue with the programme)
<i>statusVar</i> =1	The Vernier DataQuest™ application is in data collection mode. <b>Note:</b> The Vernier DataQuest™ application must be in meter mode for this command to work. 
<i>statusVar</i> =2	The Vernier DataQuest™ application is not launched.

StatusVar Value	Status
<i>statusVar</i> =3	The Vernier DataQuest™ application is launched, but you have not connected any probes. <b>Note:</b> The <i>RefreshProbeVars</i> command will almost always return <i>statusVar</i> =3 in the iOS, even if you have already launched the Vernier DataQuest™ application

- Your TI-Basic programme will read directly from Vernier DataQuest™ variables in the symbol table.
- The *meter.time* variable shows the last value of the variable; it does not update automatically. If no data collection has occurred, *meter.time* will be 0 (zero).
- Use of variable names without corresponding probes being physically attached will result in a "Variable not defined" error.
- The *RefreshProbeVars* command will be a NOP (null command) on iOS.

### **Collecting Sensor Data using RefreshProbeVars**

1. Launch the Vernier DataQuest™ application.
2. Connect the sensor(s) you need to collect the data.
3. Run the programme you wish to use to collect data in the calculator application.
4. Manipulate the sensors and collect the data.

**Note:** You may create a programme to interact with the TI-Innovator™ Hub using  > **Hub > Send**. (See Example 2, below.) This is optional.

#### **Example 1**

```
Define temp()=
Prgm
© Check if system is ready
RefreshProbeVars status
If status=0 Then
Disp "ready"
For n,1,50
RefreshProbeVars status
temperature:=meter.temperature
Disp "Temperature: ",temperature
If temperature>30 Then
Disp "Too hot"
EndIf
© Wait for 1 second between samples
Wait 1
EndFor
Else
Disp "Not ready. Try again later"
EndIf
EndPrgm
```

## Example 2- with TI-Innovator™ Hub

```
Define tempwithhub()=  
Prgm  
© Check if system is ready  
RefreshProbeVars status  
If status=0 Then  
Disp "ready"  
For n,1,50  
RefreshProbeVars status  
temperature:=meter.temperature  
Disp "Temperature: ",temperature  
If temperature>30 Then  
Disp "Too hot"  
© Play a tone on the Hub  
Send "SET SOUND 440 TIME 2"  
EndIf  
© Wait for 1 second between samples  
Wait 1  
EndFor  
Else  
Disp "Not ready. Try again later"  
EndIf  
EndPrgm
```

## Analysing Collected Data

In the Vernier DataQuest™ application, use Graph View to analyse data. Start by setting up graphs, and then use analysis tools such as integral, statistics and curve fit to investigate the mathematical nature of the data.

**Important:** The Graph menu and Analyse menu items are only available when working in Graph View.

### Finding the Area Under a Data Plot

Use Integral to determine the area under a data plot. You can find the area under all of the data or a selected region of the data.

To find the area under a data plot:

1. Leave the graph unselected to examine all the data, or select a range to examine a specific area.
2. Click **Analyse > Integral**.
3. Select the plotted column name if you have more than a single column.

The data plot area is displayed in the View Details area.

## Finding the Slope

Tangent displays a measure of the rate at which the data is changing at the point you are examining. The value is labelled “Slope”.

To find the slope:

1. Click **Analyse > Tangent**.

A check mark appears in the menu next to the option.

2. Click the graph.

The examine indicator is drawn to the nearest data point.

The values of the plotted data are shown in the View details area and the All Details for Graph dialogue box.

You can move the examine line by dragging, clicking another point or using the arrow keys.

## Interpolating the Value Between Two Data Points

Use Interpolate to estimate the value between two data points and to determine the value of a Curve Fit between and beyond these data points.

The examine line moves from data point to data point. When Interpolate is on, the examine line moves between and beyond data points.

To use Interpolate:

1. Click **Analyse > Interpolate**.

A check mark appears in the menu next to the option.

2. Click the graph.

The examine indicator is drawn to the nearest data point.

The values of the plotted data are shown in the View Details area.

You can shift the examine line by moving the cursor with the arrow keys or by clicking on another data point.

## Generating Statistics

You can generate statistics (minimum, maximum, mean, standard deviation and number of samples) for all the collected data or for a selected region. You can also generate a curve fit based on one of several standard models or on a model that you define.

1. Leave the graph unselected to examine all the data, or select a range to examine a specific area.
2. Click **Analyse > Statistics**.
3. Select the plotted column name if you have more than a single column. For example, run1.Pressure.

The Stats dialogue box opens.

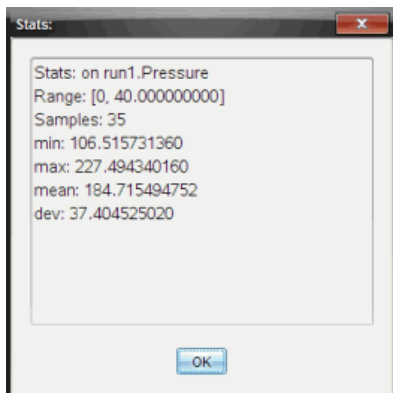

4. Review the data.
5. Click **OK**.

For information on clearing the Statistics analysis, see *Removing Analysis Options*.

## Generating a Curve Fit

Use Curve Fit to find the best curve fit to match the data. Select all of the data or a selected region of data. The curve is drawn on the graph.

1. Leave the graph unselected to examine all the data, or select a range to examine a specific area.
2. Click **Analyse > Curve Fit**.
3. Select a curve fit option.

Curve Fit option	Calculated in the form:
Linear	$y = m*x + b$
Quadratic	$y = a*x^2 + b*x + c$
Cubic	$y = a*x^3 + b*x^2 + c*x + d$
Quartic	$y = a*x^4 + b*x^3 + c*x^2 + d*x + e$
Power ( $ax^b$ )	$y = a*x^b$
Exponential ( $ab^x$ )	$y = a*b^x$
Logarithmic	$y = a + b*\ln(x)$
Sinusoidal	$y = a*\sin(b*x + c) + d$
Logistic ( $d \neq 0$ )	$y = c/(1 + a*e^{(-bx)}) + d$
Natural Exponential	$y = a*e^{(-c*x)}$
Proportional	$y = a*x$

The Fit Linear dialogue box opens.

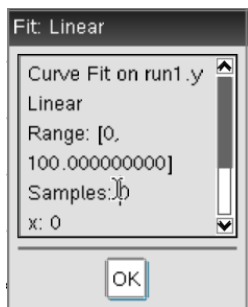

4. Click **OK**.
5. Review the data.

For information on clearing the Curve Fit analysis, see *Removing Analysis Options*.

## Plotting a Standard or User-Defined Model

This option provides a manual method for plotting a function to fit data. Use one of the predefined models or enter your own.

You can also set the spin increment to use in the View Details dialogue box. Spin increment is the value by which the coefficient changes when you click the spin buttons in the View Details dialogue box.

For example, if you set  $m=1$  as the spin increment, when you click the up spin button the value changes to 1.1, 1.2, 1.3 and so on. If you click the down spin button, the value changes to 0.9, 0.8, 0.7 and so on.

1. Click **Analyse > Model**.

The Model dialogue box opens.

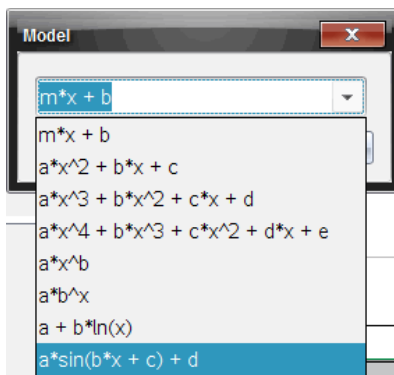

2. Type your own function.

—or—

Click to select a value from the drop-down list.

3. Click **OK**.

The Set Coefficient Values dialogue box opens.

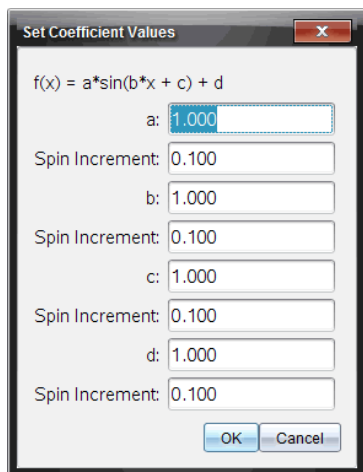

4. Type the value for the variables.
5. Type the change in value in the Spin Increment fields.
6. Click **OK**.

**Note:** These values are the initial values. You can also adjust these values in the View Details area.

The model is shown on the graph with adjustment options in the View Details area and in the All Details for Graph dialog box.

7. (Optional) Adjust the window setting for minimum and maximum axis values. For more information, see *Setting the Axis for One Graph*.

For information on clearing the Model analysis, see *Removing Analysis Options*.

8. Click  to make any desired adjustments to the coefficients.

—or—

Click the value in the View Details area.

This graphic is an example of a model with adjusted values.

### Removing Analysis Options

1. Click **Analyse > Remove**.
2. Select the data display you want to remove.

The display you selected is removed from the graph and the View Details area.



## ***Displaying Collected Data in Graph View***

When you collect data, it is written in both the Graph and Table views. Use the Graph view to examine the plotted data.

**Important:** The Graph menu and Analyse menu items are only active when working in Graph View.

### **Selecting the Graph View**

► Click the **Graph View** tab .

### **Viewing Multiple Graphs**

Use the Show Graph menu to show separate graphs when using:

- A sensor that plots more than one column of data.
- Multiple sensors with different defined units at the same time.

In this example, two sensors (the Gas Pressure sensor and the Hand Dynamometer) were used in the same run. The following image shows the columns Time, Force and Pressure in the Table view to illustrate why two graphs are shown.

### ***Displaying One of Two Graphs***

When two graphs are displayed, the top graph is Graph 1 and the bottom graph is Graph 2.

To display only Graph 1:

► Select **Graph > Show Graph > Graph 1.**

Only Graph 1 is displayed.

To display only Graph 2:

► Select **Graph > Show Graph > Graph 2.**

Only Graph 2 is displayed.

### ***Displaying Both Graphs***

To display both Graph 1 and Graph 2 together:

► Select **Graph > Show Graph > Both.**

Graph 1 and Graph 2 are displayed.

## Displaying Graphs in the Page Layout View

Use the Page layout view when Show Graph is not the appropriate solution for showing more than one graph.

The Show Graph option is not applicable for:

- Multiple runs using a single sensor.
- Two or more of the same sensors.
- Multiple sensors that use the same column(s) of data.

To use Page Layout:

1. Open the original data set you want to see in two graph windows.
2. Click **Edit > Page Layout > Select Layout**.
3. Select the type of page layout you want to use.
4. Click **Click here to add an application**.
5. Select **Add Vernier DataQuest™**.

The Vernier DataQuest™ application is added to the second view.

6. To see separate views, click the view you want to change, and then select **View > Table**.

The new view is displayed.

7. To show the same view, click the view to change.
8. Click **View > Graph**.

The new view is displayed.

## Displaying Collected Data in Table View

Table view provides another way to sort and view collected data.

### Selecting the Table View

- ▶ Click the **Table View** tab .

### Defining Column Options

You can name columns and define the decimal points and the precision you want to use.

1. from the **Data** menu, select **Column Options**.

**Note:** You can be in the Meter, Graph or Table view and still click these menu options. The results will still be visible.

2. Click the name of the column you want to define.

The Column Options dialogue box opens.

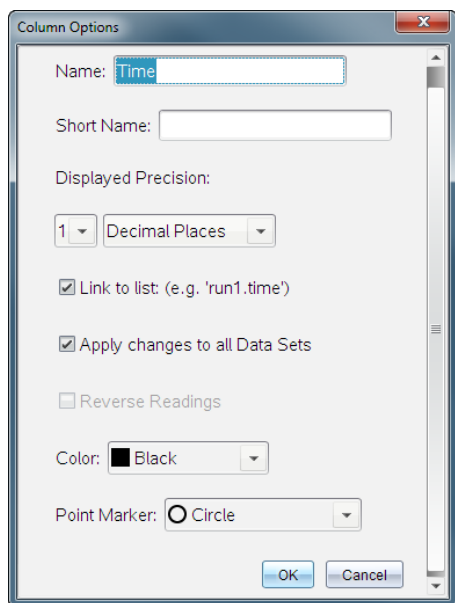

3. Type the long name for the column in the **Name** field.
4. Type the abbreviated name in the **Short Name** field.

**Note:** This name is displayed if the column cannot expand to display the full name.

5. Type the number of units in the **Units** field.
6. From the **Displayed Precision** drop-down list, select the precision value.

**Note:** The default precision is related to the precision of the sensor.

7. Select **Link to list** to link to the symbol table and make this information available to other TI-Nspire™ applications.

**Note:** Linking is the default for most sensors.

**Important:** Heart rate and blood pressure sensors require a tremendous amount of data to be useful, and the default for these sensors is to be unlinked to improve system performance.

8. Select **Apply changes to all Data Sets** to apply these settings to all data sets.
9. Click **OK**.

The column settings are now defined with the new values.

### Creating a Column of Manually Entered Values

To enter data manually, add a new column. Sensor columns cannot be modified, but data entered manually can be edited.

1. Click **Data > New Manual Column**.

The Column Options dialogue box opens.

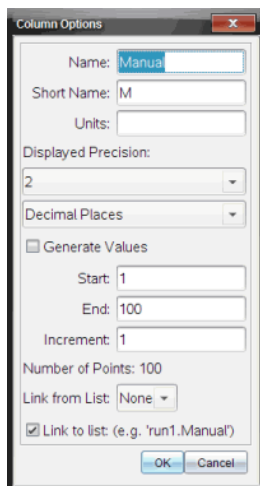

2. Type the long name for the column in the **Name** field.
3. Type the abbreviated name in the **Short Name** field.

**Note:** This name is displayed if the column cannot expand to display the full name.

4. Type the units to be used.
5. From the **Displayed Precision** drop-down list, select the precision value.

**Note:** The default precision is related to the precision of the sensor.

- (Optional) Select **Apply changes to all Data Sets** to apply these settings to all data sets.
- (Optional) Select **Generate Values** to automatically populate the rows.

If you select this option, complete these steps:

- Type a starting value in the **Start** field.
- Type an ending value in the **End** field.
- Type the increase in value in the **Increment** field.

The number of points is calculated and shown in the Number of Points field.

- Select **Link from list** to link to data in another TI-Nspire™ application.

**Note:** This list only populates when data exists in the other application and includes a column label.

- Select **Link to list** to link to the symbol table and make this information available to other TI-Nspire™ applications.

**Note:** Linking is the default for most sensors.

**Important:** Heart rate and blood pressure sensors require a tremendous amount of data to be useful, and the default for these sensors is to be unlinked to improve system performance.

- Click **OK**.

A new column is added to the table. This column can be edited.

### Creating a Column of Calculated Values

You can add an additional column to the data set in which the values are calculated from an expression using at least one of the existing columns.

Use a calculated column when finding the derivative for pH data. For more information, see *Adjusting Derivative Settings*.

- Click **Data > New Calculated Column**.

The Column Options dialogue box opens.

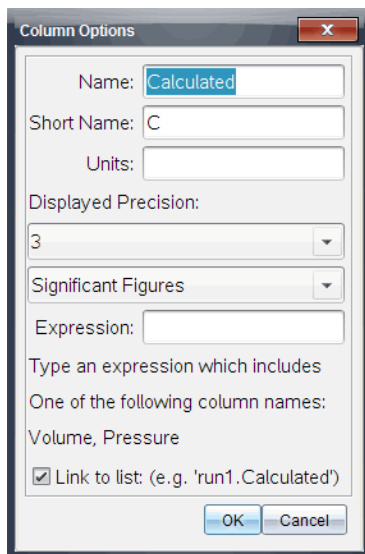

2. Type the long name for the column in the **Name** field.
3. Type the abbreviated name in the **Short Name** field.

**Note:** This name is displayed if the column cannot expand to display the full name.

4. Type the units to be used.
5. From the **Displayed Precision** drop-down list, select the precision value.

**Note:** The default precision is related to the precision of the sensor.

6. Type a calculation including one of the column names in the **Expression** field.

**Note:** The system-provided column names are dependent on the sensor(s) selected and any changes made to the name field in Column Options.

**Important:** The Expression field is case-sensitive. (Example: “Pressure” is not the same as “pressure”.)

7. Select **Link to list** to link to the symbol table and make this information available to other TI-Nspire™ applications.

**Note:** Linking is the default for most sensors.

**Important:** Heart rate and blood pressure sensors require a tremendous amount of data to be useful, and the default for these sensors is to be unlinked to improve system performance.

- Click **OK**.

The new calculated column is created.

## ***Customising the Graph of Collected Data***

You can customise the Graph view by adding a title, changing colours and setting ranges for the axis.

### **Adding a Title**

When you add a title to a graph, the title is displayed in the View Details area. When you print the graph, the title prints on the graph.

- Click **Graph > Graph Title**.

The Graph Title dialogue box opens.

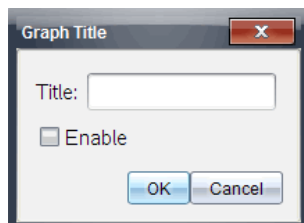

If there are two graphs in the work area, the dialogue box has two title options.

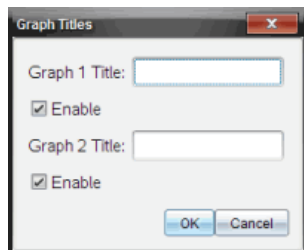

- Type the name of the graph in the Title field.

—or—

- Type the name of the first graph in the Graph 1 field.
  - Type the name of the second graph in the Graph 2 field.
- Select **Enable** to show the title.

**Note:** Use the Enable option to hide or show the graph title as needed.

4. Click **OK**.

The title is shown.

## Setting Axis Ranges

### Setting Axis Ranges for One Graph

To modify the minimum and maximum range for the x and y axis:

1. Click **Graph > Window Settings**.

The Window Settings dialogue box opens.

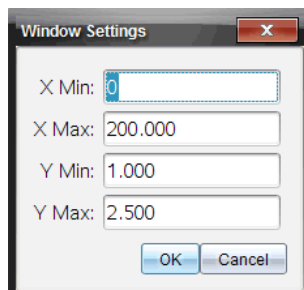

2. Type the new values in one or more of these fields:

- X Min
- X Max
- Y Min
- Y Max

3. Click **OK**.

The application uses the new values for the graph visual range until you modify the range or change data sets.

### Setting Axis Ranges for Two Graphs

When working with two graphs, enter two y axis minimum and maximum values, but only one set of minimum and maximum values for the x axis.

1. Click **Graph > Window Setting**.

The Window Setting dialogue box opens.



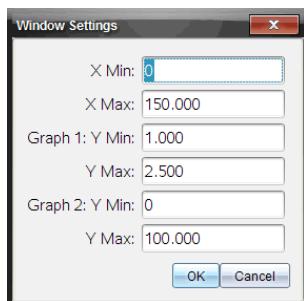

2. Type the new values in one or more of these fields:

- X Min
- X Max
- Graph 1: Y Min
- Y Max
- Graph 2: Y Min
- Y Max

3. Click **OK**.

The application uses the new values for the graph visual range until you modify the range or change data sets.

### ***Setting the Axis Range on the Graph Screen***

You can modify the minimum and maximum range for the x and y axes directly on the graph screen.

► Select the axis value that you want to change, and type a new value.

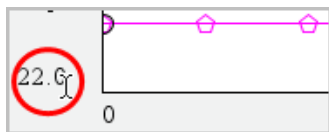

The graph is redrawn to reflect the change.

### **Selecting which Data Sets to Plot**

1. In the Detail view on the left, click the tab immediately below the view selection buttons.

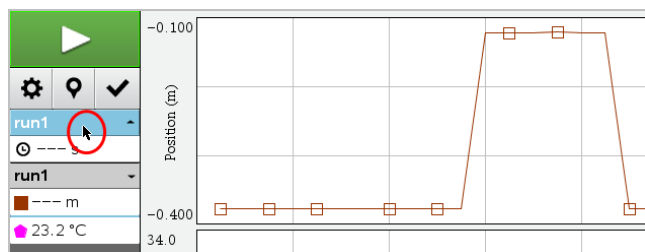

2. The Detail view shows a list of available data sets.
3. Use the tick boxes to select the data sets to plot.

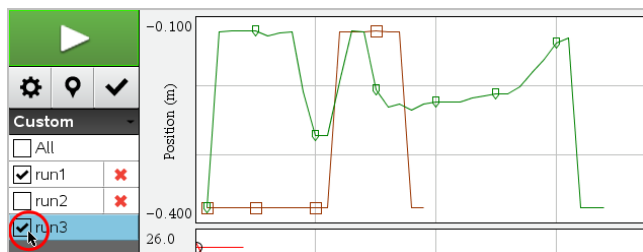

## Autoscaling a Graph

Use the autoscale option to show all the points plotted. Autoscale Now is useful after you change the x and y axis range or zoom in or out of a graph. You can also define the automatic autoscale setting to use during and after a collection.

### *Autoscale Now Using the Application Menu*

- ▶ Click **Graph > Autoscale Now**.

The graph now displays all the points plotted.

### *Autoscale Now Using the Context Menu*

1. Open the context menu in the graph area.
2. Click **Window/Zoom > Autoscale Now**.

The graph now displays all the points plotted.

## ***Defining Autoscale During a Collection***

There are two options for using the automatic autoscaling that occurs during a collection. To choose an option:

1. Click **Options > Autoscale Settings**.

The Autoscale Settings dialogue box opens.

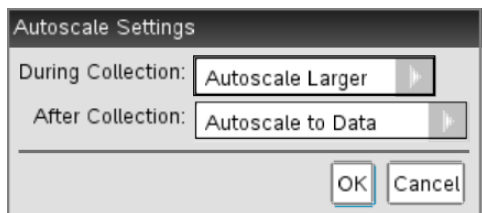

2. Click ► to open the During Collection drop-down list.
3. Select one of these options:
  - **Autoscale Larger** - Expands the graph as needed to show all points as you collect them.
  - **Do Not Autoscale** - The graph is not changed during a collection.
4. Click **OK** to save the setting.

## ***Defining Autoscale After a Collection***

You have three options for setting the automatic autoscaling that occurs after a collection. To set your choice:

1. Click **Options > Autoscale Settings**.

The Autoscale Settings dialogue box opens.

2. Click ► to open the **After Collection** drop-down list.
3. Select one of these options:
  - **Autoscale to Data**. Expands the graph to show all data points. This option is the default mode.
  - **Autoscale From Zero**. Modifies the graph so all data points including the origin point are displayed.
  - **Do Not Autoscale**. The graph settings are not changed.

4. Click **OK** to save the setting.

### Selecting a Range of Data

Selecting a range of data on the graph is useful in several situations, such as when zooming in or out, striking and un-striking data and examining settings.

#### *To select a range:*

1. Drag across the graph.

The selected area is indicated by grey shading.

2. Perform one of these actions.

- Zoom in or out
- Strike or un-strike data
- Examine settings

#### *To deselect a range:*

- ▶ Press the **Esc** key as necessary to remove the shading and the vertical trace line.

### Zooming In on a Graph

You can zoom in on a subset of the collected points. You can also zoom out from a previous zoom or expand the graph window beyond the data points collected.

To zoom in on a graph:

1. Select the area you want to zoom into, or use the current view.
2. Click **Graph > Zoom In**.

The graph adjusts to display only the area you selected.

The x range selected is used as the new x range. The y range autoscales to show all graphed data points in the selected range.

### Zooming Out of a Graph

- ▶ Select **Graph > Zoom Out**.

The graph is now expanded.

If a Zoom In precedes a Zoom Out, the graph displays the original settings prior to the Zoom In.

For example, if you Zoomed In twice, the first Zoom Out would display the window of the first Zoom In. To display the full graph with all data points from multiple zoom ins, use Autoscale Now.

### Setting Point Options

To indicate how often marks show on the graph and whether to use a connecting line:

1. Click **Options > Point Options**.

The Point Options dialogue box opens.

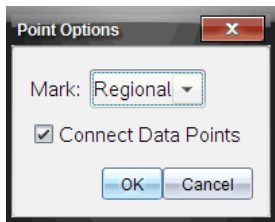

2. Select a **Mark** option from the drop-down list.
  - **None**. No point protectors.
  - **Regional**. Periodic point protectors.
  - **All**. Every data point as a point protector.
3. Select **Connect Data Points** to display a line between points.

—or—

Clear **Connect Data Points** to remove the line between points.

The following graphics show examples of some of the Point Mark options.

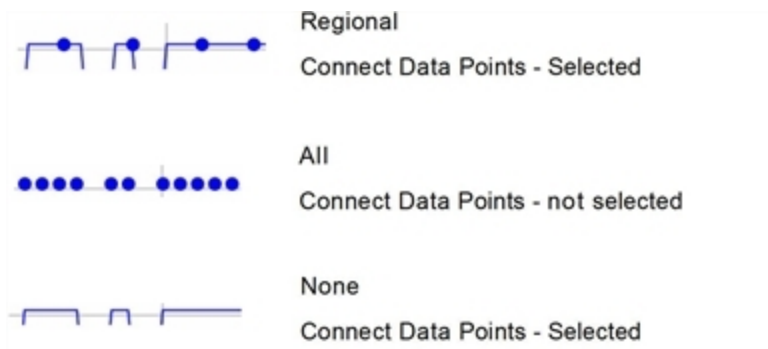

## Changing a Graph's Colour

1. Click the point indicator for the graph whose colour you want to change.

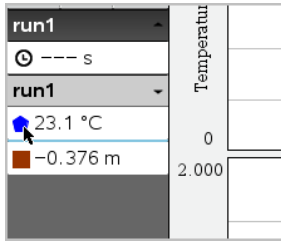

2. In the Column Options dialogue box, select the new **Colour**.

## Selecting Point Markers

1. Right-click in the graph to open the menu.
2. Click **Point Marker**.

**Note:** If there is only one dependent variable column, the Point Marker option is preceded by the data set name and column name. Otherwise, the Point Marker option has a menu.

3. Select the column variable to change.
4. Select the point marker to set.

The Point Marker changes to the option selected.

## Selecting an Independent Variable Column

Use the option Select X-axis Column to select the column used as the independent variable when graphing the data. This column is used for all graphs.

1. Click **Graph > Select X-axis Column**.
2. Select the variable you want to change.

The x-axis label on the graph changes and the graph is reordered using the new independent variable for graphing the data.

## Selecting a Dependent Variable Column

Use the option Select Y-axis Column to select which dependent variable columns to plot on the displayed graph(s).

1. Click **Graph > Select Y-axis Column**.

2. Select one of the following:

- A variable from the list. The list is a combination of dependent variables and the number of data sets.
- **More.** Selecting More opens the Select dialogue box. Use this when you want to select a combination of data set variables to graph.

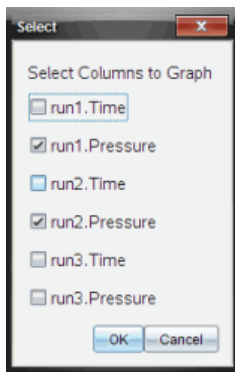

### Showing and Hiding Details

You can hide or show the Details view on the left side of the screen.

- ▶ Click **Options > Hide Details** or **Options > Show Details**.

### Showing and Hiding Axes Tick Labels

You can hide or show the axes tick labels on a graph.

- ▶ Click **Options > Hide tick labels** or **Options > Show tick labels**.

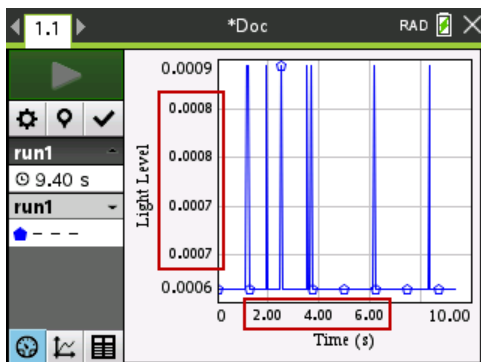

## Notes:

- When a Vernier DataQuest™ application is added to a document, the tick labels will default to being displayed.
- Tick labels may not be displayed if there is a lack of available space. Minimum and maximum values will always be displayed.
- Tick labels cannot be edited, but they will recalculate as needed if the minimum or maximum values are edited or the window settings are changed.

## Striking and Restoring Data

Striking data omits it temporarily from the Graph view and from the analysis tools.

1. Open the data run that contains the data to be struck.
2. Click **Table View** .
3. Select the region by dragging from the starting row to the ending point.

The screen scrolls so you can see the selection.

4. Click **Data > Strike Data**.
5. Select one of the following:
  - **In Selected Region**. Strike the data from the area you selected.
  - **Outside Selected Region**. Strike all data except the area you selected.

The selected data is marked as struck in the table and is removed from the graph view.

### Restoring Struck Data

1. Select the range of data to restore or if restoring all struck data, start at step two.
2. Click **Data > Restore Data**.
3. Select one of the following:
  - **In Selected Region** - Restore data in the selected area.
  - **Outside Selected Region** - Restore data outside the selected area.
  - **All Data** - Restore all data. No data selection necessary.

The data is restored.

## Replaying the Data Collection

Use the Replay option to playback the data collection. This option lets you:

- Select the data set you want to replay.
- Pause the playback.
- Advance the playback by one point at a time.
- Adjust the playback rate.



- Repeat the playback.

### Selecting the Data Set to Replay

You can replay one data set at a time. By default, the latest data set plays using the first column as the base column (example: time reference).

If you have multiple data sets, and want a different data set or base column than the default, you can select the data set to replay and the base column.

To select the data set to replay:

1. Click **Experiment > Replay > Advanced Settings**.

The Advanced Replay Settings dialogue box opens.

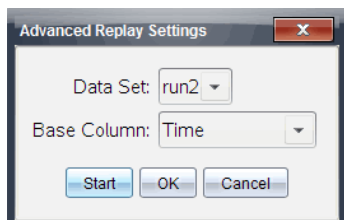

2. Select the data set to replay from the Data Set drop-down list.

**Note:** Changing the run in the Data Set selection tool does not affect the playback choice. You must specify which data set in **Experiment > Replay > Advance Settings**.

3. (Optional) Select a new value from the Base Column drop-down list.

The selected column acts as the “Time” column for the replay.

**Note:** The base column should be a strictly increasing list of numbers.

4. Click **Start** to start the playback and save the settings.

**Note:** Data Set and Base Column options are based on the number of stored runs and the sensor type used.

### Starting and Controlling the Playback

- ▶ Select **Experiment > Replay > Start Playback**.

Playback begins, and the Data Collection Control buttons change to:



Pause



Resume



Stop



Advance by One Point (enabled only during pause)

## Adjusting the Playback Rate

To adjust the playback rate:

1. Select **Experiment > Replay > Playback Rate**.

The Playback Rate dialogue box opens.

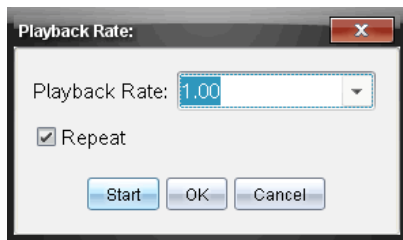

2. In the Playback Rate field, click ▼ to open the drop-down list.
3. Select the rate at which the playback will play.

Normal speed is 1.00. A higher value is faster and a lower value is slower.

4. Select one of the following options:
  - Click **Start** to start the playback and save the settings.
  - Click **OK** to save the settings for use on the next playback.

## Repeating the Playback

1. Select **Experiment > Replay > Start Playback**.
2. Click **Start** to start the playback and save the settings.

## Adjusting Derivative Settings

Use this option to select the number of points to use in derivative calculations. This value affects the tangent tool, velocity and acceleration values.

Find pH derivative settings using a calculated column.

The Vernier DataQuest™ application can determine a numeric derivative from a list of data with respect to another list of data. The data can be collected using sensors, input

manually, or linked with other applications. The numerical derivative is found using a calculated column.

To determine the numerical 1st derivative of List B with respect to List A, enter the following expression in the Column Options dialogue:

**derivative(B,A,1,0) or derivative(B,A,1,1)**

To determine the numerical 2nd derivative of List B with respect to List A, enter the following expression:

**derivative(B,A,2,0) or derivative(B,A,2,1)**

The last parameter is either 0 or 1 depending on the method you are using. When it is 0, a weighted average is used. When it is 1, a time shifted derivative method is used.

**Note:** The first derivative calculation (weighted average) is what the Tangent tool uses to display the slope at a data point when examining data. (Analyse > Tangent).

**Note:** The derivative calculation is completely row based. It is recommended that your List A data be sorted in ascending order.

1. Click **Options > Derivative Settings**.

The Settings dialogue box opens.

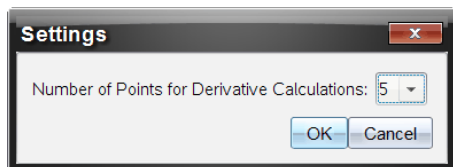

2. Select the number of points from the drop-down list.
3. Click **OK**.

## ***Drawing a Predictive Plot***

Use this option to add points to the graph to predict the outcome of an experiment.

1. Click the **Graph View** tab .
2. From the **Analyse** menu, select **Draw Prediction > Draw**.
3. Click each area in which you want to place a point.
4. Press **Esc** to release the drawing tool.

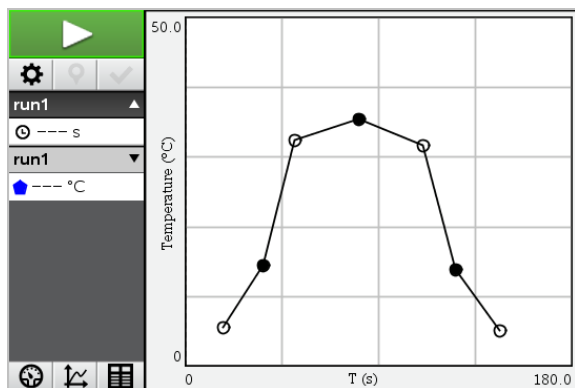

- To clear the drawn prediction, click **Analyse > Draw Prediction > Clear**.

### **Using Motion Match**

Use this option to create a randomly generated plot when creating position-versus-time or velocity-versus-time graphs.

This feature is only available when using a motion detector such as the CBR 2™ sensor or the Go!Motion® sensor.

#### **Generating a Motion Match Plot**

To generate a plot:

- Attach the motion detector.
- Click **View > Graph**.
- Click **Analyse > Motion Match**.
- Select one of the following options:
  - New Position Match**. Generates a random position plot.
  - New Velocity Match**. Generates a random velocity plot.

**Note:** Continue selecting a new position or a new velocity match to generate a new random plot without removing the existing plot.

#### **Removing a Motion Match Plot**

To remove the generated plot:

- ▶ Click **Analyse > Motion Match > Remove Match**.

### **Printing Collected Data**

You can only print from the computer. You can print any single displayed active view, or with the Print All option:

- One data view.
- All of the data views.

- A combination of the data views.

The Print All option has no effect on applications outside of the Vernier DataQuest™ application.

## Printing Data Views

To print a data view:

1. On the main menu (top of the window), click **File > Print**.

The Print dialogue box opens.

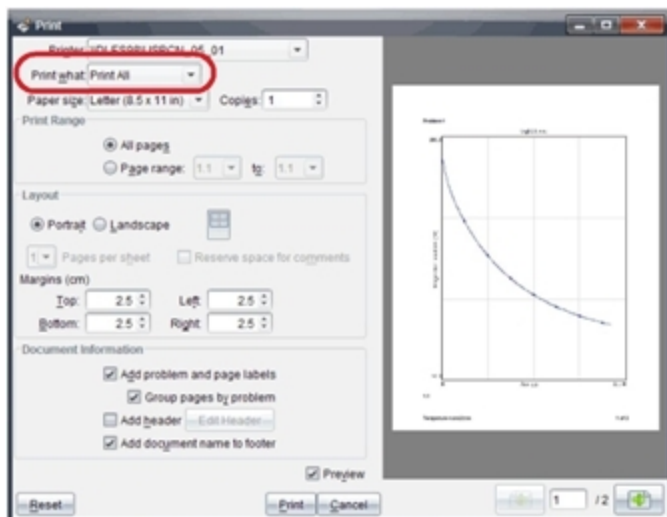

2. Select **Print All** from the Print what drop-down list.
3. Select additional options, if needed.
4. Click **Print** to send the document to the printer.

## Setting Options for the Print All Feature

1. Click **Options > Print All Settings**.

The Print All Settings dialogue box opens.

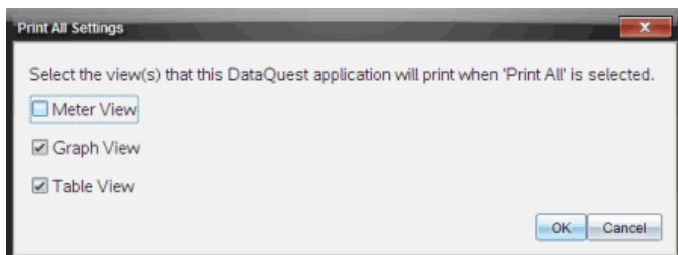

2. Select the views you want to print.
  - **Print Current View.** The current view is sent to the printer.
  - **Print All Views.** All three views (Meter, Graph and Table) are sent to the printer.
  - **More.** Only the views you select are sent to the printer.
3. Click **OK**.

The Print All Settings are now complete and can be used when printing.

# Widgets

All work that you create and save using TI-Nspire™ applications is stored as a document, which you can share with others using TI-Nspire™ software, a TI-Nspire™ CX II handheld, or the TI-Nspire™ App for iPad®. You save these TI-Nspire™ documents as .tns files.

A Widget is a .tns document that is stored in your MyWidgets folder.

You can use Widgets to:

- Easily access text files
- Insert and run scripts (such as the pre-loaded widget example: Stopwatch.tns)
- Quickly insert a saved problem into a document

When you add a Widget, TI-Inspire™ CX extracts only the first page of the selected .tns file, and inserts it into your open document.

## ***Creating a Widget***

A document is regarded as a Widget when it is saved or copied to the designated MyWidgets folder. The default location is:

- Windows®: My Documents\TI-Nspire\MyWidgets.
- Mac®: Documents/TI-Nspire/MyWidgets.
- Handheld: MyWidgets
- TI-Nspire™ App for iPad® and TI-Nspire™ CAS App for iPad®: MyWidgets

If the MyWidget folder has been inadvertently deleted, you must create it before attempting to use a Widget.

**Note:** When you add a Widget, TI-Inspire™ CX extracts only the first page of the selected .tns file, and inserts it into your open document.

## ***Adding a Widget***

### **Adding a Widget to a New Document**

1. Open a new document.

2. Click **Add Widget**.

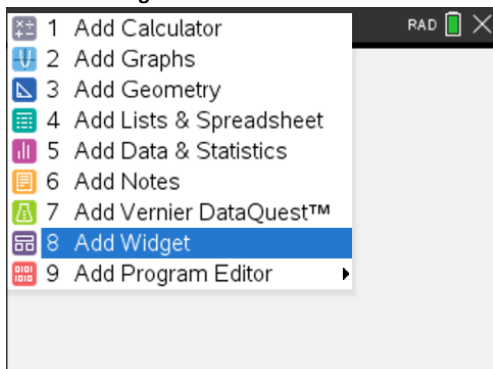

3. Scroll to select a .tns file from the box.

4. Click **Add**.

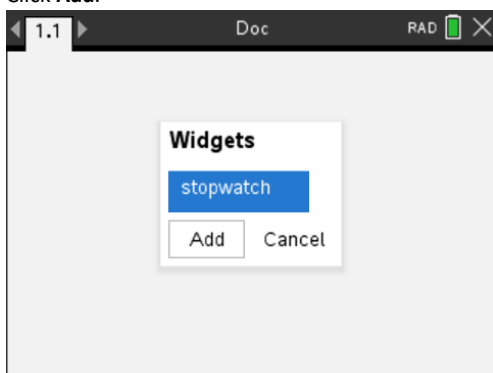

**Note:** Stopwatch is a preloaded .tns file. Any saved .tns file will show up in this list.

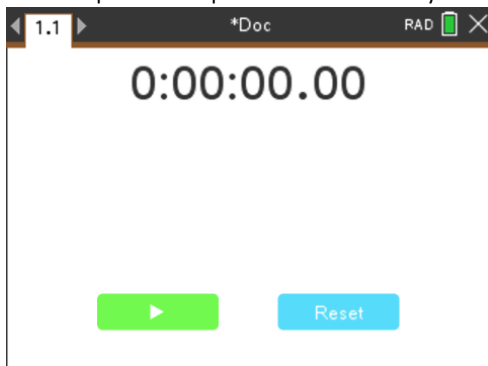



## Adding a Widget to an Existing Document

1. Click **Doc > Insert > Widget**.

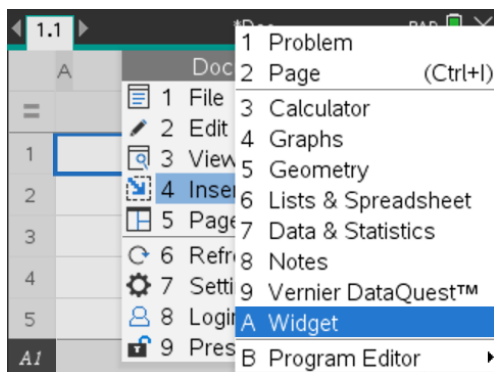

2. Click **Add**.

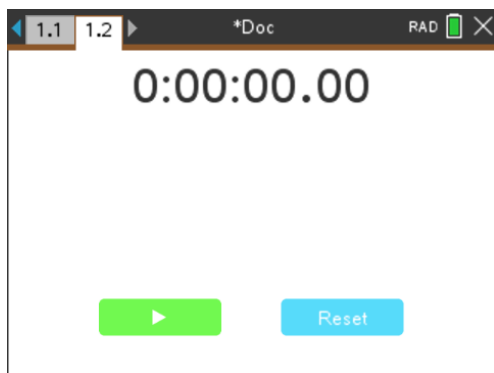
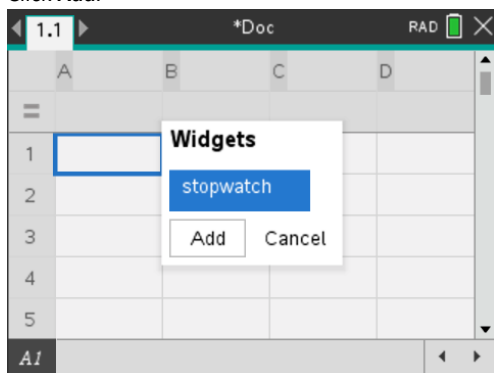

**Note:** You can also add a Widget to a new or existing document using the **Insert** menu.

## Saving a Widget

1. Click .
2. Navigate to MyDocuments > MyWidgets.
3. Type in a name for your Widget.

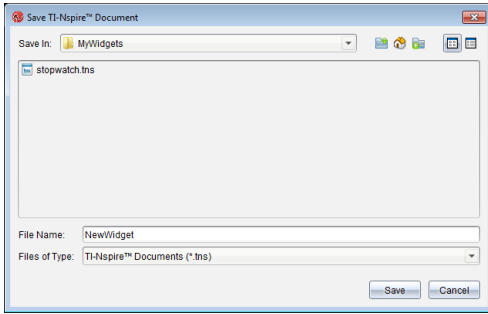

4. Click **Save**.

# Libraries

## What is a Library?

A library is a TI-Nspire™ document that contains a collection of variables, functions and/or programmes that have been defined as library objects.

Unlike ordinary variables, functions and programmes, which can be used only within a single problem (the problem in which they are defined), library objects are accessible from any document. You can even create public library objects that appear in the TI-Nspire™ Catalogue.

For example, suppose you have created library document **matrix** containing public library function **diagwithtrace()** and a private library function **errmsg()**.

Function **diagwithtrace()** displays the diagonal of a square matrix and calculates the trace of the matrix. If its input is not a square matrix, the function calls **errmsg()**, which should then return an appropriate error string.

```
Define LibPub diagwithtrace(m)=  
Func  
© diagwithtrace(mat): diagonal with trace  
If rowDim(m)≠colDim(m) Then  
  Return errmsg("not_square")  
Else  
  Disp diag(m)  
  Return trace(m)  
EndIf  
  
Define LibPriv errmsg(msgcode)=  
Func  
© Private library function errmsg(msgcode)  
...  
If msgcode="not_square" Then  
  Return "Error: matrix is not square"  
EndIf  
...  
EndFunc
```

You could then use the following syntax to display the diagonal and calculate the trace of matrix *m* defined in the current problem:

```
matrix\diagwithtrace(m)
```

## Creating Libraries and Library Objects

A document is regarded as a library when it is saved or copied to the designated library folder. The default location is:

- Windows®: My Documents\TI-Nspire\MyLib.
- Mac®: Documents/TI-Nspire/MyLib.
- Handheld: MyLib

If the folder has been inadvertently deleted, you must create it before attempting to use libraries.

You can define library objects using either the Programme Editor or the Calculator application. Library objects must be defined with a **Define** command and must reside in the first problem of a library document.

**Note:** If you use the Programme Editor to define a library function or programme, you must store the object and also save the document. Saving the document does not automatically store the object. For more information, see *Programming*.

Naming restrictions apply to library documents and library objects.

- A library document name must be a valid variable name between 1 and 16 characters long, and it must not contain a period or begin with an underscore.
- A library object name must be a valid variable name between 1 and 15 characters long. It must not contain a period and must not begin with an underscore.

### ***Private and Public Library Objects***

When you define a library object, you designate it as private (LibPriv) or public (LibPub).

**Define a=5**

*a* is not a library object.

**Define LibPriv b={1,2,3}**

*b* is a private library object.

**Define LibPub func1(x)=x^2 - 1**

*func1* is a public library object.

A **Private** library object does not appear in the Catalogue, but you can access it by typing its name. Private objects serve well as building blocks that perform basic, low-level tasks. Typically, private library objects are called upon by the public functions and programmes.



A **Public** library object appears in the Catalogue's library tab after you refresh the libraries. You can access a public library object through the Catalogue or by typing its name.

Mac® only: In version 1.4 of the software, a library document name cannot contain extended characters, such as Ö, á or ñ.

**Note:** In library programmes and functions defined as public, a comment line (©) immediately following the **Prgm** or **Func** line is automatically displayed as help in the Catalogue. You could, for example, show a syntax reminder there.

## Using Short and Long Names

Anytime you are in the same problem where an object is defined, you can access it by entering its short name (the name given in the object's **Define** command). This is the case for all defined objects, including private, public and non-library objects.

You can access a library object from any document by typing the object's long name. A long name consists of the name of the object's library document followed by a backslash "\" followed by the name of the object. For example, the long name of the object defined as **func1** in the library document **lib1** is **lib1\func1**. To type the "\" character on the handheld, press  .

**Note:** If you cannot remember the exact name or the order of arguments required for a private library object, you can open the library document or use the Programme Editor to view the object. You also can use **getVarInfo** to view a list of objects in a library.



## Using Library Objects

Before using a library variable, function or programme, make sure that these steps have been followed:

- The object has been defined with the **Define** command, and the command specifies either the LibPriv or LibPub attribute.
- The object resides in the first problem of a library document. The document must reside in the designated library folder and must meet the naming requirements.
- If you defined the object using the Programme Editor, it has been stored using **Check Syntax & Store** from the Programme Editor menu.
- The libraries have been refreshed.

### Refreshing the Libraries

- ▶ Refresh libraries to make the library objects available to your documents.
  - From the **Tools** menu, click **Refresh Libraries**.

Handheld: Press   and click **Refresh Libraries**.

### Using a Public Library Object

1. Refresh the libraries.
2. Open the TI-Nspire™ application in which you want to use the variable, function or programme.

**Note:** All applications can evaluate functions, but only the Calculator and Notes applications can run programmes.

3. Open the Catalogue and use the library tab to find and insert the object.
4. If arguments are required, type them inside the parentheses.



### Using a Private Library Object

1. Refresh the libraries.

2. Open the TI-Nspire™ application in which you want to use the variable, function or programme.

**Note:** All applications can evaluate functions, but only the Calculator and Notes applications can run programmes.

3. Type the name of the object, such as `lib1\func1()`.

In case of a function or programme, always follow the name with parentheses. To type the “\” character on the handheld, press  .

4. If arguments are required, type them inside the parentheses.

## ***Creating Shortcuts to Library Objects***

You can make the objects in a library more easily accessible by using **libShortcut()** to create shortcuts to them. This creates a variable group in the current problem that contains references to all the objects in the specified library document. You can choose to include or exclude the private library objects.

For example, suppose the library document `linalg` contains functions named `clearmat`, `cofactor`, `gausstep`, `help`, `inversestep`, `kernelbasis`, `rank` and `simultstep`. Executing **libShortcut("linalg", "la")** would create a variable group containing the following members:

```
la.clearmat
la.cofactor
la.gausstep
la.help
la.inversestep
la.kernelbasis
la.rank
la.simultstep
```

You can refer to those library objects from within the current problem by typing their variable names or by selecting them from the Variables menu.

For more details about using **libShortcut()**, see the *Reference Guide*.

## ***Included Libraries***

To help you get started with libraries, the TI-Nspire™ Software installation includes a library document with useful Linear Algebra functions. The library is named **linalg** or **linalgCAS** and is installed in the designated library folder.

**Note:** Updating the handheld’s operating system or reinstalling the computer software places all included libraries in the default folder. If you have edited an object in an included library or replaced an included library with your own document of the same name, updating or reinstalling will overwrite your changes. This could also happen after batteries are replaced or the handheld system is reset.

## Restoring an Included Library

If you inadvertently delete or overwrite an included library, you can restore it from the installation DVD.

1. Open the DVD, and navigate to the **libs** folder.
2. Identify the library file to restore, such as **linalg.tns** or **linalgCAS.tns** for the linear algebra library.
3. Copy the file.
  - Windows®: Copy the file to your designated library folder. The default location is **My Documents\TI-Nspire\MyLib**.
  - Mac®: Copy the file to your designated library folder. The default location is **Documents/TI-Nspire/MyLib**.
  - Handheld: Connect the handheld to your computer, open the TI-Nspire™ software, and copy the library file to the handheld's **MyLib** folder.
4. Activate the new library objects.
  - From the TI-Nspire™ Software **Tools** menu, click **Refresh Libraries**.  
Handheld: Press **ctrl** **menu**, and click **Refresh Libraries**.

# Using the TI-SmartView™ Emulator

With three layout options to choose from, teachers will find that the emulator facilitates classroom presentations. In the teacher software, layout options are:

- Handheld Only
- Keypad + SideScreen
- Handheld + SideScreen

In the student software, the TI-SmartView™ emulator emulates the keypad, which along with the handheld view, gives students the ability to drive the software as if using a handheld.

## Opening the TI-SmartView™ Emulator

The TI-SmartView™ emulator is located in the Documents Workspace. To open the emulator view:

1. Open the Documents Workspace.
2. Click , which is located in the Documents Toolbox.

In the teacher software, the handheld is displayed with Handheld and SideScreen panels open in computer mode as shown in the following illustration. You can use the keypad on the emulated handheld, but the document won't appear on the emulated handheld screen until you switch to Handheld mode.

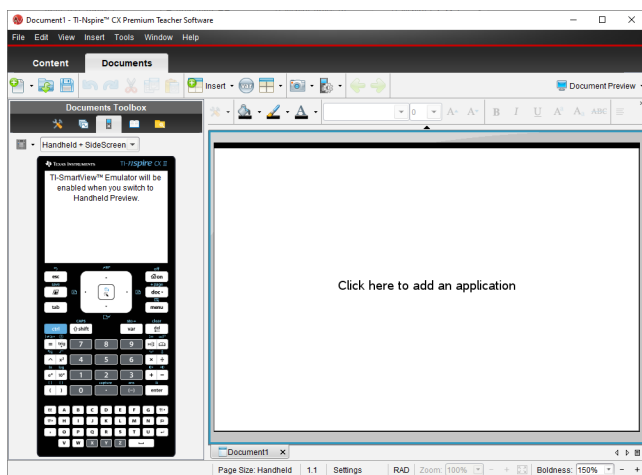

In the student software, the TI-Nspire™ CX II keypad is displayed with the side screen open in computer mode. You can use the keypad on the emulated handheld to work with the document in the side screen in either computer mode or handheld mode.



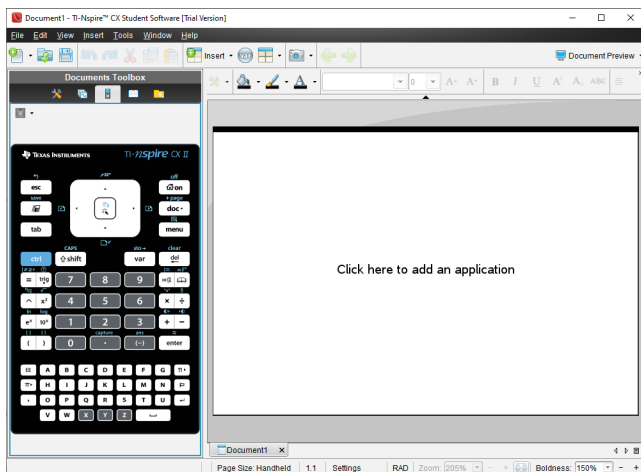

### 3. Click **View > Handheld**.

—or—

Click  in the status bar to switch to handheld mode.

## Choosing Display Options

In the teacher software, use this option to choose how to display the emulator in the software window.

### 1. In the emulator panel, click .

—or—

Click **File > Settings > TI-SmartView™ Options**.

### 2. Select one of the following options:

- **Handheld Only.** Displays the emulated handheld and hides the workspace and other panels.

**Note:** To keep the Handheld Only display in front of other application windows, click **Always in Front** at the top right of the TI-SmartView™ panel.

- **Keypad + SideScreen.** Opens a larger view of the keypad along with the side screen.
- **Handheld + SideScreen.** Opens the entire emulated handheld along with the side screen.

## Changing the Faceplate

To select a faceplate option:

### 1. In the emulator panel, click to open the menu.

—or—

Click **File > Settings > TI-SmartView™ Options**.

2. Select one of the following options:

- Dark
- Light
- Outline

### Changing the Width of the TI-SmartView™ Panel

To change the width of the TI-SmartView™ emulator panel:

- ▶ Click the right edge of the panel and drag it until it is the width you want.

### Changing the Size of the Screen in the Workspace

When in handheld mode, use the Scale to change the size of the screen.

- ▶ Drag the slider to the appropriate scale percentage. The scale slider is located on the far right side of the status bar, at the bottom of the TI-Nspire™ window. Scale percentages range from 100% to 200%. The default scale is 150%.

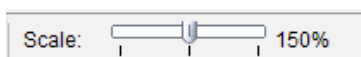

**Note:** If computer mode is selected, you cannot change the size of the workspace.

### Working with the Emulated Handheld

To input data and work with files on the emulator, you can use the computer keyboard, TI-SmartView™ keypad, TI-Nspire™ menus and icons or any combination of these.

**Note:** Within one command, you cannot use a combination of both the keypad and the keyboard. For example, you cannot press **Ctrl** on the keyboard and click **menu** on the emulator to open a context menu.

For the most part, you can perform any function in the TI-SmartView™ emulator that you can perform on the handheld. Keys and applications operate the same way.

**Note:** If you switch to Computer mode, you can still use most of the keys on the emulated handheld or keypad and all keystrokes are reflected in the workspace. However, some key combinations may only work in Handheld mode.

As you click keys on the emulator or press keys on the keyboard that activate keys on the emulator, those keys change colour, making it easy for your audience to follow along. The last key selected stays highlighted.

In the teacher software, the emulator screen and the side screen are both interactive. You can click on icons and menu items on both screens. You can also right-click to display menus on both screens.

All handheld shortcuts and arrow functionality work from the computer keyboard. For example, to save a document, you can click **ctrl** **S** on the emulator keypad or you can press **Ctrl + S** on the computer keyboard. When using a Mac®, press **⌘ + S**.

## Using the Touchpad

You can operate the Touchpad on the TI-Nspire™ Touchpad keypad using either the touchpad on a laptop or by using the mouse to click the Touchpad. Areas of the Touchpad are highlighted as you click the arrow zones.

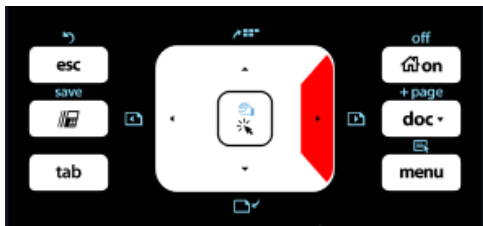

An arrow is highlighted when you press or tap it.

- Clicking the ◀, ▶, ▲, or ▼ keys on the Touchpad moves through menus one item at a time.
- Clicking and holding down an arrow on the Touchpad causes continual movement in the selected direction.
- Clicking and sliding the mouse across the Touchpad area enables you to move the mouse pointer.
- Clicking the middle of the Touchpad selects the highlighted menu option.

## Using Settings and Status

When working with the TI-SmartView™ emulator, you can change General Settings and Document Settings. For more information, see *Using the Documents Workspace*.

You can view all other settings, but you cannot change them in the TI-SmartView™ emulator. However, the ability to view these options provides teachers with an instructional tool when they need to show students how to set up a handheld.

To view settings and status:

1. Click  to access the Home screen.
2. Click **Settings**.

Setting or Settings	Description
Language	You can open the languages menu and select a language, but you cannot save changes. To change the language, use the TI-Nspire™ menu <b>File &gt; Settings &gt; Change Language</b> option.
Handheld Setup	You can open the menus and select items to demonstrate which items to choose, but you cannot save any changes.
Handheld	You can access the screen. The # symbol replaces any numeric

Setting or Settings	Description
Status	values that would be displayed on the handheld.
About	You can open the About screen and view the software version. Other information that pertains only to the handheld hardware is marked as "Not Applicable".
Login	You can display the Login to Class screen and type in the User Name and Password fields. <b>Login</b> is not available.

## Changing TI-SmartView™ Options

You can change the emulator options, even when the emulator panel is closed.

1. In the teacher software, click **File > Settings > TI-SmartView™ Options**.

The TI-SmartView™ Options dialogue box opens.

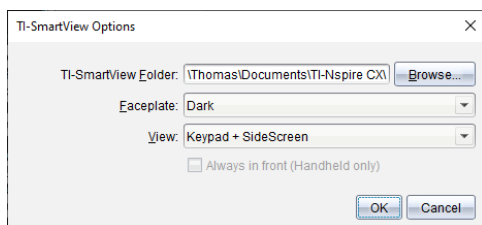

In the student software, click **File > Settings > Keypad Options**.

The Keypad Options dialogue box opens.

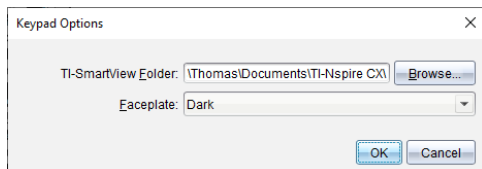

2. Click Browse to change the folder where documents are saved and accessed in the My Documents folder when using the emulator.

**Important:** If you change the TI-SmartView™ location, you must also copy or move the MyLib folder and paste it to the new location to see library objects.

The default location of MyLib is:

- Windows®: Documents\TI-Nspire\MyLib.
- Mac®: Documents/TI-Nspire/MyLib.

**Note:** Close and reopen the TI-Nspire™ application for the libraries to reflect the change.

3. Click ▼ to open the menu and select a faceplate.
4. In the teacher software, click ▼ to open the menu and select a view. If selecting **Handheld Only**, select **Always in Front** to keep this window on top of all other open applications.
5. Click **OK** to save the settings.

## ***Working with Documents***

You can open multiple documents in the workspace by selecting **File > Open Document** from the menu or using keyboard shortcuts. When you switch between these documents, the emulated handheld shows only the current document. You can insert pages and problems using either the TI-Nspire™ menus or icons, keyboard shortcuts or TI-SmartView™ menus or shortcuts.

### **Opening a Document**

You can open a document by navigating to it on the emulator, the same way you open a document on the handheld, or you click **File > Open Document**.

When you open a document using the emulator, you can only open documents that are in the folder displayed on the emulator (usually the My Documents folder, unless you specified a different folder in your TI-SmartView™ settings). When you open a document using the menu path, you can browse to find any TI-Nspire™ document on your computer or network. If you open a document using the emulated handheld, it replaces the document that was previously open.

**Note:** If the number of characters in the document's file path name exceeds 256 characters, the document cannot be opened and an error message is displayed. To avoid this error, keep file and folder names short or move files up in the file path.

### **Saving a Document**

When you save a document using the **File > Save Document** menu or icon, keyboard shortcuts, keypad shortcuts or emulator menus, the document is saved in the same location where the file was opened. To save the file in another location or with a different name, click **File > Save As**.

## ***Using Screen Capture***

To capture the current page, press **Ctrl + J** (Mac®: **⌘ + J**) on your keyboard or on the emulated handheld. The image is automatically placed in the Clipboard and in the TI-Nspire™ Screen Capture window. You can paste the image into another application without having to take additional steps. This feature is only available when the TI-SmartView™ panel is active and the workspace is in Handheld mode.

All other screen capture features work the same way they do in other areas of TI-Nspire™ software. For more information, see *Capturing Screens*.

## Using the Help Menu

Use the Help menu to find useful information to help you use the software more productively. You can:

- Open the PDF help file (press **F1** or click **Help**).
- Open the web-based help file (press **F2** or click **Online Help**).
- Activate your software license.
- Register your TI product.
- Explore TI resources such as Activities Exchange, where you can find lessons, quizzes and other instructive activities shared by teachers.
- Explore online troubleshooting.
- Check for updates to the software or updates to operating systems for TI-Nspire™ handhelds and the TI-Nspire™ Lab Cradle.
- Check to see which version of the software you are using.

### **Activating Your Software Licence**

1. Ensure that your computer is connected to the Internet.
2. From the **Help** menu, select **Activate** to open the Texas Instruments Activation Wizard.
3. Click **Activate your Licence**, and then click **Next**.

The Complete Software Activation dialogue box opens.

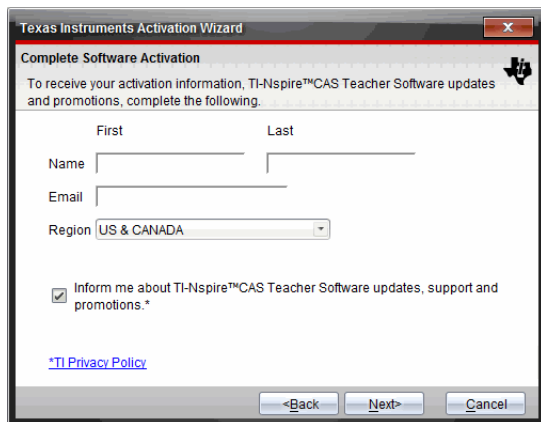

4. Complete the name and email fields, and then select the region where you live if different from the default entry. If you want to receive emails from TI about updates, support and promotions, ensure the tick box is selected.
5. Click **Next**.

The Activate your software dialogue box opens.

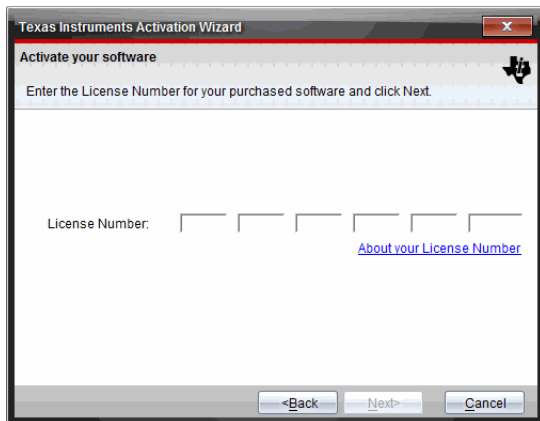

6. Type the licence number.
7. Click **Next**.

The Licence Agreement dialogue box opens.

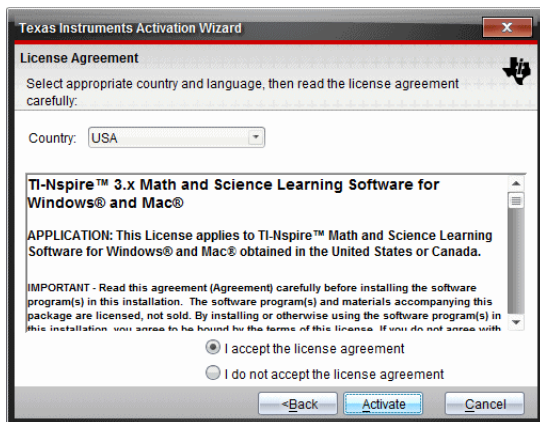

8. In the Country field, select your country from the drop-down list if it is different from the default entry.
9. Review the licence agreement, and then select to accept the agreement.
10. Click **Activate**. The licence number is validated against the TI database to ensure it is valid.

If the licence number is valid, the Successful Activation dialogue box opens. If the licence number is not valid, check to make sure the numbers are entered correctly. If the problem persists, contact TI Support.

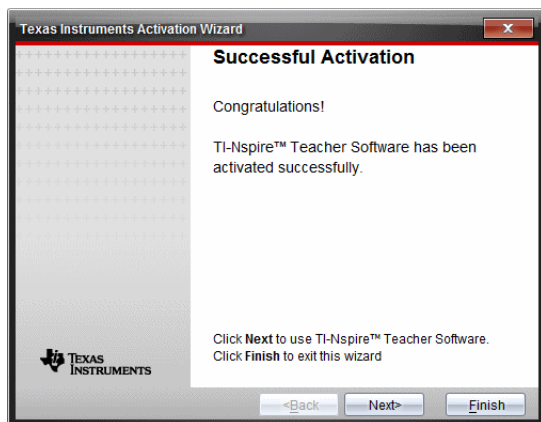

11. Click **Next** to continue, or select **Finish** to complete the installation with default settings.
12. When prompted, click **OK** to accept the default location for your TI-Nspire™ folder. If needed, navigate to the location on your computer where you want to store your TI-Nspire™ documents and files.
13. Select whether or not to replace any documents that have the same name.

The software launches and the **Welcome Screen** opens.

### ***Registering Your Product***

1. Ensure that your computer is connected to the Internet.
2. From the **Help** menu, select **Register** to access the TI Product Registration site.
3. Follow the instructions on the website.

### ***Downloading the Latest Guidebook***

1. Ensure that your computer is connected to the Internet.
2. From the **Help** menu, select **Download latest Guidebook**.

The Education Technology website opens with the Guidebooks tab active.

3. Click the title of the Guidebook that you want to download.

A PDF version of the Guidebook opens on your desktop.

### ***Exploring TI Resources***

The Help menu also provides links to TI resources and websites.

- ▶ Select **Help > Visit education.ti.com** to access the Texas Instruments Education Technology website.



- ▶ Select **Help > Visit Activities Exchange** to access the Texas Instruments Activities Exchange, site, a forum where you can browse by subject to find ready-to-use maths and science learning activities appropriate for secondary school to college.

**Note:** Activities available for download may vary depending on your geographical region.

- ▶ Select **Help > Explore Online Troubleshooting** to access the TI Knowledge Base where you can find general information, troubleshooting help, product usage tips and information specific to TI products.

## **Updating the TI-Nspire™ Software**

### **Update the Software**

1. Ensure that your computer is connected to the Internet.
2. Close any open documents.
3. From the **Help** menu, select **Check for Upgrades and Notifications**.
  - If your software is current, a confirmation message appears.
  - If your software is not current, you are prompted to update.
4. Click **Update** to download and install the update, or click **Close** to cancel.

A progress indicator shows the download progress. If you receive a connection error, check your Internet connection and try again.

**Note for users updating TI-Nspire™ Navigator™ Teacher Software:** Your portfolio and class records reside on your computer as a database. Because the new software might have features that are not supported in the old database structure, the old data might need to be converted. When conversion is necessary, a Database Update tool helps you make a backup of the old database. The tool appears during the first startup of the updated software.

### **Manage Automatic Checking**

Automatic checking uses the Internet to check for upgrades each time you open the TI-Nspire™ software. If your system is not up-to-date, you receive a notification. You can turn automatic checking on or off.

1. From the **Help** menu, select **Check for Upgrades and Notifications**.
2. Tick or clear the **Automatically check for updates** tickbox.
3. Click **Close**.

## **Updating the OS on a Connected Handheld**

**Note:** To avoid losing unsaved data, close all documents on the handheld before updating its operating system.

1. Ensure that your computer is connected to the Internet.
2. In the Documents Toolbox, click the Content Explorer tab  to show connected handhelds.
3. Select the handheld that you are updating.

4. From the **Help** menu, select **Check for OS Updates**.

- If the operating system is current, a confirmation message appears.

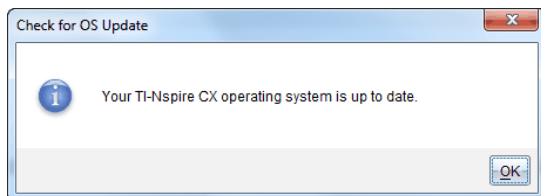

- If the operating system is not current, the TI-Nspire™ software prompts you to install the latest OS now. If the updated OS file is not already available on your computer, you can choose a location for it.

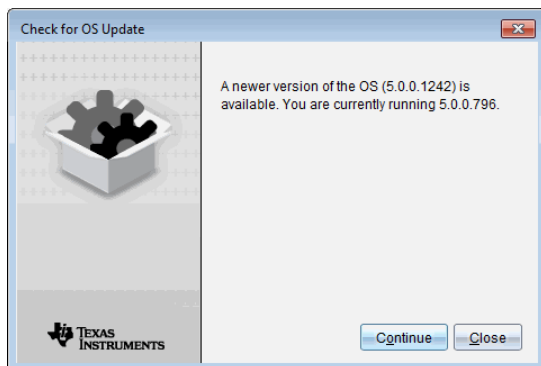

5. Click **Continue** and follow the prompts to install the OS on the handheld, or click **Close** to cancel.

When the update is complete, the handheld restarts automatically.

## ***Viewing Software Version and Legal Information***

1. From the Help menu, select **About TI-Nspire™ <Product Name>Software**.

**Note:** You do not need an Internet connection to open this screen.

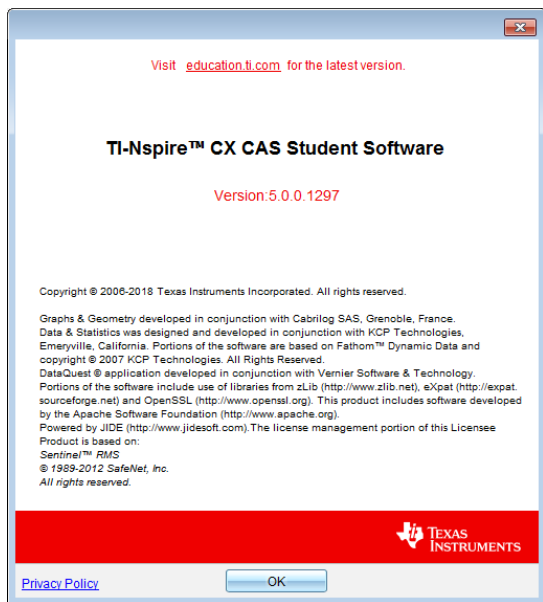

2. Click **OK** to close the window.

## ***Helping Improve the Product***

This product includes a feature that can help TI improve the product by automatically collecting anonymous information about product usage and reliability.

**Note:** Depending on how your software was installed, you might see the following screen the first time you start the software. You also can access the feature manually.

1. From the **Help** menu, select **Product Improvements**.
2. Read the information on the screen, and click one of the buttons:
  - To allow information to be collected, click **Yes, I want to help**.
  - To prevent collection, click **No thanks**.

# Using Test Mode

The guidelines for many international, national, and state assessments allow or require students to use TI-Nspire™ Student Software when taking an exam. Test Mode enables you to quickly prepare the software for exams where use of applications, programmes, and other files is restricted.

Test Mode can be configured by using either the **Choose Test Mode Restrictions** or **Enter Test Code** option. When the software is in Test Mode, students cannot access pre-existing folders, documents, or Scratchpad data. After the exam, these documents and features can be easily restored for classroom use.

The Test Mode feature is available on **Windows® computers only** at this time in the following versions:

- TI-Nspire™ CX Student Software version 5.3 or higher
- TI-Nspire™ CX CAS Student Software version 5.3 or higher

**Note:** To find out if your state allows TI-Nspire™ technology, see the State/Province Information website at [education.ti.com/go/testprep](http://education.ti.com/go/testprep).

## Entering Test Mode by Choosing Restrictions

**Note:** This applies to TI-Nspire™ CX and TI-Nspire™ CX CAS software except where noted. If you already have a test code, you can use the [Enter Test Code method](#).

1. Select **File > Test Mode > Choose Test Mode Restrictions**.

This will open the Test Mode Configuration dialogue box.

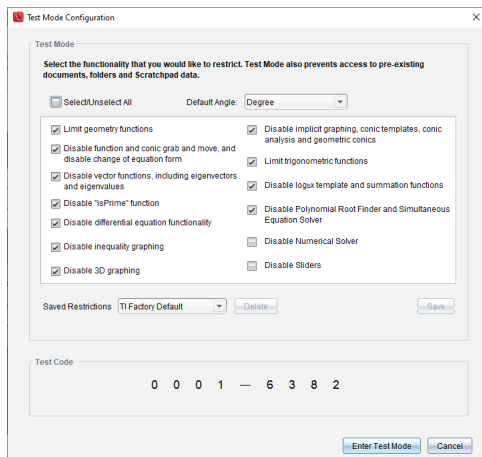

2. On the **Default angle** list, select the angle unit you wish to use. Available units are Degree and Radian.
3. Select the **CAS Mode** you wish to use. (TI-Nspire™ CX CAS Student Software only)

- **On** enables CAS functions and symbol manipulation.
  - **Exact Arithmetic** enables exact results in terms of stacked fractions,  $\pi$ , and radicals  $\sqrt{\phantom{x}}$ .
  - **Off** disables CAS and exact results.
4. Select the **Exact Arithmetic** mode you wish to use. (TI-Nspire™ CX Student Software only with the TI-Nspire™ CX II-T handheld type selected)
- **On** enables exact results in terms of stacked fractions,  $\pi$ , and radicals  $\sqrt{\phantom{x}}$ .
  - **Off** disables exact results.
5. Click the tick box for each restriction to select or deselect it.

Click the **Select / Unselect All** box to quickly select or clear all restrictions.

In the Test Mode Code section, the code will automatically update based on your selections.

**Note:** For a detailed list of restrictions, refer to [Understanding Test Mode Restrictions](#).

6. (Optional) To save the current settings as a named configuration:
- Click **Save**.
  - Type a **Name** into the **Save Configuration** dialogue box.
  - Click **Save**.
7. Click **Enter Test Mode**.
- If there are any open documents or screenshots, you will be prompted to save them.
  - The software window will maximise to the full size of your display and open a new document.
  - Pre-existing clipboard and TI-Nspire™ Scratchpad data is deleted.
  - A green title bar indicates that the software is in Test Mode. It displays the Configuration Name (if any), Test Code, the CAS or Exact Arithmetic mode status (when appropriate), time elapsed while in the test session, the information icon, and the Exit button.

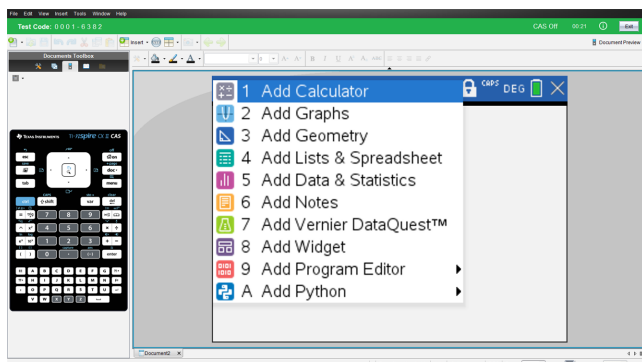

## Entering Test Mode with a Test Code

**Note:** This applies to TI-Nspire™ CX and TI-Nspire™ CX CAS software except where noted. If you do not know the test code, you can obtain it by using the [Choose Restrictions method](#).

1. Select **File > Test Mode > Enter Test Code**.

This will open the Test Mode Configuration dialogue box.

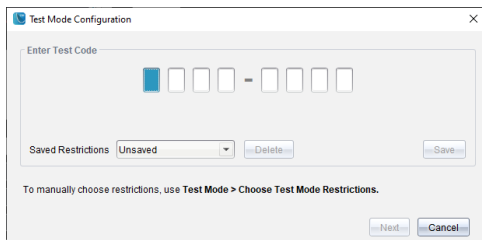

2. Enter your eight-digit test code.

If the code is valid, a green tickmark will display. The following example uses the TI Factory Default Code 0001-6382.

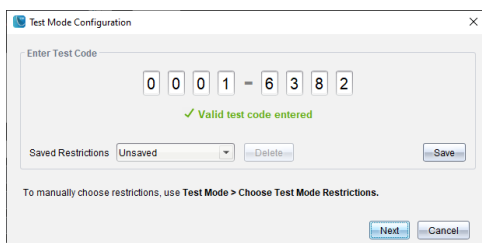

When the code is validated, it is stored and will be displayed when the **Enter Test Mode Code** dialogue is invoked again.

The same test codes are used for both TI-Nspire™ Student Software and TI-Nspire™ CAS Student Software. The CAS and Exact Arithmetic Mode settings are ignored when appropriate.

3. Click **Next**.

The Summary screen displays so you can review the restrictions. Click **Back** if you need to enter a different code.

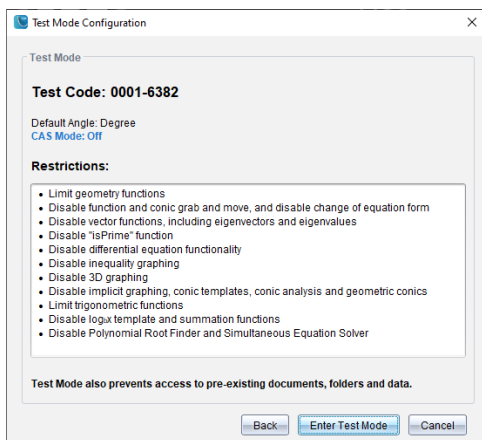

#### 4. Click **Enter Test Mode**.

- If there are any open documents or screenshots, you will be prompted to save them.
- The software window will maximise to the full size of your display and open a new document.
- Pre-existing clipboard and TI-Nspire™ Scratchpad data is deleted.
- A green title bar indicates that the software is in Test Mode. It displays the Configuration Name (if any), Test Code, the CAS or Exact Arithmetic mode status (when appropriate), time elapsed while in the test session, the information icon, and the Exit button.

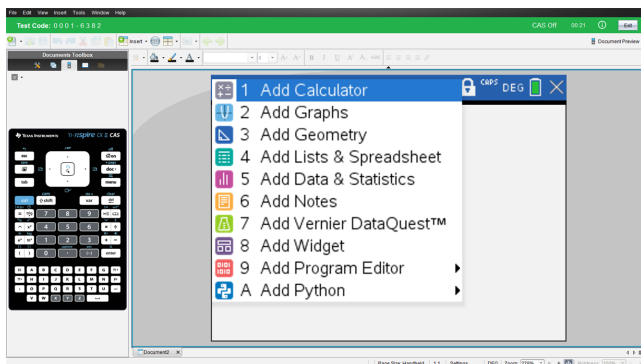

## Test Code Examples

### *TI Factory Default Restrictions*

- Default Angle = Degree
- CAS Mode = Off

- Numerical Solver enabled

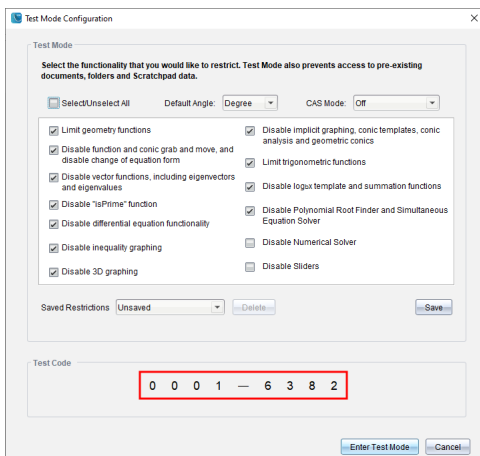

### Minimum Restrictions

- Default Angle = Degree
- CAS Mode = On
- All restrictions off

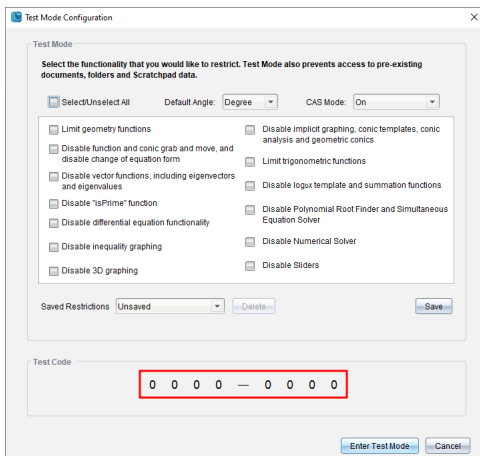

### Maximum Restrictions

- Default Angle = Degree
- CAS Mode = Off
- All restrictions on



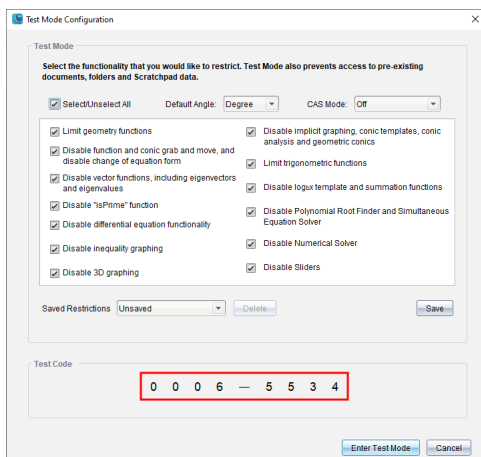

**Note:** Maximum restrictions Test Code will change if additional restrictions are added in the future.

## Reviewing Test Mode Restrictions

You can review the restrictions in effect when the software is in Test Mode. You cannot change the restrictions while in the testing session. You must exit Test Mode and re-enter it with new restrictions.

To review the current restrictions:

1. Click the information icon  in the Test Mode bar.

The Test Mode Information dialogue opens which displays the following:

- Press-to-Test code
- Time in Test Mode
- Default Angle
- CAS Mode (TI-Nspire™ CX CAS Student Software only)
- Exact Arithmetic (TI-Nspire™ CX Student Software only with the TI-Nspire™ CX II-T handheld type selected)
- Restrictions
- Log of timestamps for various events

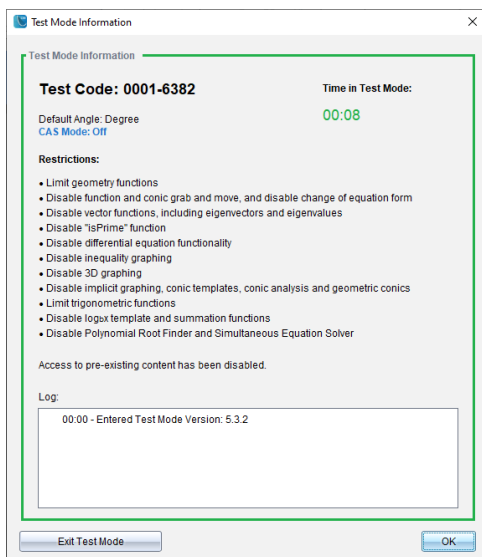

2. Click **OK** to return to the current test session, or click **Exit Test Mode** to end the session.

## ***Working with a Document in Test Mode***

While in Test Mode, you will only see documents you have created during the test session. You cannot open documents that were created before entering Test Mode.

### **Creating a New Document**

1. On the TI-Nspire™ **File** menu,
  - Select **New TI-Nspire™ Document - Handheld Page Size**.
  - Or—
  - Select **New TI-Nspire™ Document - Computer Page Size**.

The new document opens in the Documents Workspace, and you are prompted to select an application.

2. Select an application to add a problem to the document.

The problem is added to the document.

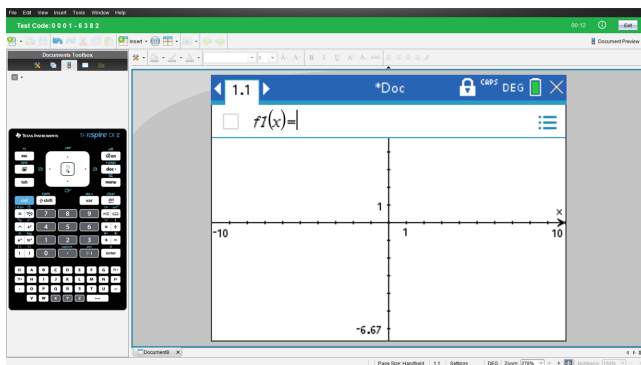

## Losing Software Focus in Test Mode

The TI-Nspire™ CX Student Software is designed to keep the user in Test Mode without access to other applications for the duration of the test. If the focus shifts away from the software, the title bar will turn red.

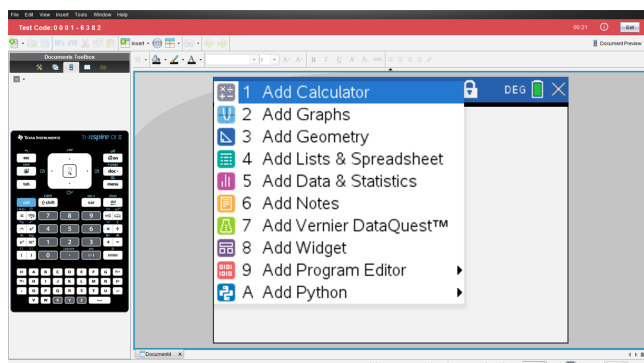

This activity is recorded as "Left Test Mode" on the Test Mode Summary dialogue (below) and in the TestLog PDF file that is available after exiting the Test Mode.

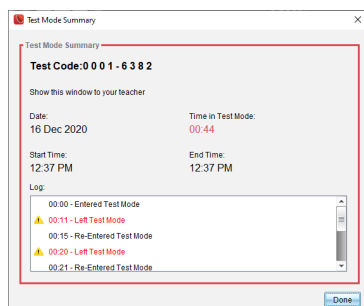

**Note:** To avoid any unintentional shifts away from Test Mode, it is recommended that other applications be closed or disabled beforehand, especially screen capture, accessibility, or other others that run in the background.

## Exiting Test Mode

When you exit Test Mode, any document created during the session is deleted and system settings are restored to their state before you entered Test Mode.

To exit Test Mode:

1. Click the **Exit** button on the Test Mode title bar.
2. On the **Exit Test Mode** prompt, click **Yes**.

The Test Mode Summary dialogue opens which displays the following:

- Press-to-Test code
- Date
- Time in Test Mode
- Start Time and End Time
- Log of timestamps for various events

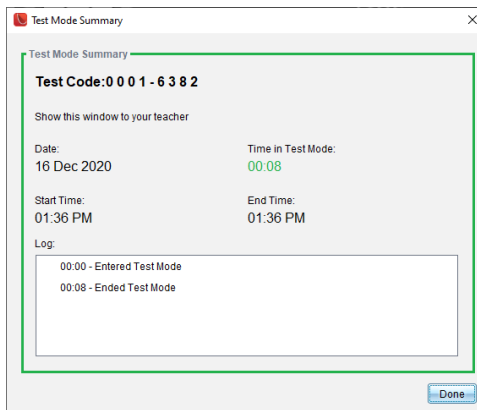

3. Click **Done**.

The Save as PDF dialogue opens. This allows you to save the TestLog PDF file that contains the information from the Test Mode Summary dialogue.

4. Select a location on your computer to save the TestLog and click **Save**.

The software is restored to a state as if it were just launched.

## Understanding Test Mode Restrictions

By default, all restrictions are selected when you enter Test Mode, with the exception of Numerical Solver.

- Selecting a restriction disables or limits its associated features during the Test Mode session.
- Clearing a restriction allows its associated features to be used during the session.

### Restricting Geometry Functions

When you choose to limit geometry functions, all items on the **Measurement**, **Construction** and **Transformation** menus are disabled.

### Restricting Graphs Functions

On the Graphs menu, the following items are disabled:

- **Actions > Coordinates and Equations**
- **Geometry > Measurement, Construction, and Transformation**

### Disabling Function and Conic Grab and Move

- You cannot move any function or conic in Graphs, Geometry, or Scratchpad. For example, if you have graphed  $y=x^3$ , you can select the function but you cannot move or manipulate it by dragging.
- You cannot access the attribute that toggles the displayed form of a conic equation between Standard and Expanded.
- Disabling function and conic grab and move does not apply to lines and functions in Data & Statistics.
- Disabling function grab and move does not restrict sliders in the Graphs and Geometry applications.
- You can still grab the coordinate plane and move it around.

### Disabling Vector Functions

When vector functions are disabled, students cannot calculate the following functions:

- Unit vector [unitV()]
- Cross product [crossP()]
- Dot product [dotP()]
- Eigenvector [eigVc()]
- Eigenvalue [eigVI()]

## Disabling the “isPrime” Function

The `isPrime(` function determines if a number is a prime number (a whole number greater than two that is evenly divisible only by itself and one). Disabling this function prevents students from selecting the `isPrime(` command in the Catalogue and from selecting **Test > IsPrime** in Maths Operators. If a student manually enters the `isPrime(` function, submitting the expression results in an error message.

## Disabling Differential Equation Functionality

The Differential Equation graph type is disabled in the Graphs and Geometry applications. Users cannot manually type and graph a differential equation.

Related maths functions `rk23(`, `euler(`, and `deSolve(` are also disabled.

## Disabling Inequality Graphing

When inequality graphing is disabled, students cannot graph inequalities with  $<$ ,  $>$ ,  $\leq$  and  $\geq$  or grab and drag inequalities to a graph in the Graphs, Geometry and Scratchpad applications.

## Disabling 3D Graphing

When this feature is disabled, students cannot use the 3D Graphing view.

## Disabling Implicit Graphing, Conic Templates, Conic Analysis, and Geometric Conics

When these features are disabled, students cannot graph equations in terms of  $x = ay + c$  or  $ax + by = c$ . Conic templates are not available, and students cannot analyse conics or graph the geometric conic of an ellipse, parabola, hyperbola or conic by five points.

## Disabling Trigonometric Functions

Disabling trigonometric functions prevents students from using the following functions in calculations and graphing.

<code>csc</code>	<code>sec</code>	<code>cot</code>
<code>csc<sup>-1</sup></code> , <code>arccsc</code>	<code>sec<sup>-1</sup></code> , <code>arcsec</code>	<code>cot<sup>-1</sup></code> , <code>arccot</code>
<code>csch</code>	<code>sech</code>	<code>coth</code>
<code>csch<sup>-1</sup></code> , <code>arccsch</code>	<code>sech<sup>-1</sup></code> , <code>arcsech</code>	<code>coth<sup>-1</sup></code> , <code>arccoth</code>

- Attempting to evaluate any of these functions results in an error message.

- Students cannot select the **csc**, **sec**, **cot**, **csc-1**, **sec-1**, and **cot-1** functions by pressing  on the software.
- Students cannot select the disabled functions from the Catalog.

### Disabling the $\log_b x$ Template

Students cannot use the  $\log_b x$  (convert to logbase) and  $\log(a, b)$  commands and templates, including  $\log_b x$  templates.

- When a student presses  $[\log]$  on the software, only calculations in log10 format are accepted.
- If a student manually enters **log(a,b)** or **>logbase(** into an expression, attempting to evaluate the expression results in an error message.
- Students are allowed to enter **log(a)**, **log(a,10)** and **log(a,10.)**.

### Disabling Summation Functions and Templates

Students are prevented from using summation functions and templates. The  $\Sigma($  and **sumSeq(** functions are disabled.

### Disabling Polynomial Root Finder

The **polyRoots(**, **cPolyRoots(**, **solve(**, **simult(**, **zeros(**, and **cZeros(** functions are disabled. Attempting to evaluate any of these functions results in an error message.

**Note:** When the polynomial tools are disabled, students cannot use Find Roots of Polynomial, Real Roots of Polynomial or Complex Roots of Polynomial.

### Disabling Simultaneous Equation Solver

The **linSolve(** and **simult(** functions are disabled in menus and in the Catalogue. Attempting to evaluate either of these functions results in an error message.

### Disabling Numerical Solver

The **nSolve(** is disabled in menus and in the Catalogue. Attempting to evaluate either of these functions results in an error message.

### Disabling Sliders

When this feature is disabled, students cannot insert or create sliders in the Graphs, Geometry, Data & Statistics, and Notes applications.

## Appendix A: Conversion Categories and Units

The following table lists categories and their respective units that are available in the Unit Conversion Assistant. When the units are pasted to the entry line, underscores ( `_` ) are added before the name of each unit to differentiate them from other variables. For example:

- `_cm►_m`
- `_km/_hr►_m/_s`
- `_°C►_°F`

Category	Units
Length	Å (Angstrom)
	au (astronomical unit)
	cm (centimetre)
	dm (decimetre)
	fath (fathom)
	fm (fermi)
	ft (foot)
	in (inch)
	km (kilometre)
	ltyr (light-year)
	m (metre)
	µm (micron)
	mi (mile)
	mil (1/1000 inch)
	mm (millimetre)
	nm (nanometre)
	Nmi (nautical mile)
	pc (parsec)
rod (rod)	
yd (yard)	
Area	acre (acre)
	cm <sup>2</sup>
	dm <sup>2</sup>
	ft <sup>2</sup>
	ha (hectare)
	in <sup>2</sup>
	km <sup>2</sup>



Category	Units
	m <sup>2</sup>
	mi <sup>2</sup>
	mm <sup>2</sup>
	yd <sup>2</sup>
Volume	cm <sup>3</sup>
	cup (cup)
	dm <sup>3</sup>
	ft <sup>3</sup>
	floz (US fluid ounce)
	flozUK (British fluid ounce)
	gal (US gallon)
	galUK (British gallon)
	in <sup>3</sup>
	l (litre)
	m <sup>3</sup>
	ml (millilitre)
	pt (pint)
	qt (quart)
	tbsp (tablespoon)
	tsp (teaspoon)
	yd <sup>3</sup>
Time	day (day)
	hr (hour)
	min (minute)
	ms (millisecond)
	μs (microsecond)
	ns (nanosecond)
	s (second)
	week (week)
	yr (year)
Velocity	ft/min
	ft/s
	knot (knot)
	km/h
	km/min

Category	Units
	km/s m/s mi/h mi/min mi/s
Temperature	°C (Celsius) °F (Fahrenheit) K (kelvin) °R (Rankine)
Mass	amu (atomic mass unit) gm (gram) kg (kilogram) lb (pound) mg (milligram) mton (metric ton) oz (ounce) slug (slug) ton (ton) tonUK (long ton)
Force	dyne (dyne) kgf (kilogram force) lbf (pound force) N (newton) tonf (ton force)
Energy	BTU (British thermal unit) cal (calorie) erg (erg) eV (electron volt) ftlb (foot-pound) J (joule) kcal (kilocalorie) kJ (kilojoule) kgf*m kWh (kilowatt-hour) latm (liter-atmosphere)
Power	hp (horsepower) kW (kilowatt)

Category	Units
	PS (metric horsepower)
	W (watt)
Pressure	atm (atmosphere)
	bar (bar)
	inH <sub>2</sub> O (inches of water)
	inHg (inches of mercury)
	kPa (kilopascal)
	kgf/cm <sup>2</sup>
	lbf/in <sup>2</sup>
	mbar (millibar)
	mmH <sub>2</sub> O (millimetres of water)
	mmHg (millimetres of mercury)
	N/m <sup>2</sup>
	Pa (pascal)
	psi (pounds per square inch)
	torr (millimetres of mercury)

## General Information

### ***Online Help***

[education.ti.com/eguide](http://education.ti.com/eguide)

Select your country for more product information.

### ***Contact TI Support***

[education.ti.com/ti-cares](http://education.ti.com/ti-cares)

Select your country for technical and other support resources.

### ***Service and Warranty Information***

[education.ti.com/warranty](http://education.ti.com/warranty)

Select your country for information about the length and terms of the warranty or about product service.

Limited Warranty. This warranty does not affect your statutory rights.

Texas Instruments Incorporated

12500 TI Blvd.

Dallas, TX 75243

# Index

.tilb file ..... 56

## 3

3D aspect ratio, changing ..... 195

3D functions  
graphing ..... 189

3D graph  
changing appearance ..... 193

3D graphing ..... 446

3D Graphing view ..... 189, 191

3D graphs

animating with sliders ..... 197

editing expressions ..... 192

plot colors ..... 193

range settings ..... 195

rotating ..... 191

setting background colours ..... 194

showing/hiding ..... 194

shrinking/magnifying ..... 194

3D parametric equations

graphing ..... 190

3D projection type ..... 194

## A

activating software licences ..... 430

add files to lesson bundle ..... 50

adding

applications ..... 40

colours ..... 36

copyrights to documents (.tns) ..... 47

pages ..... 44

problems ..... 44

titles to graphs ..... 399

Adding files to a lesson bundle ..... 50

adding images ..... 67

alternative hypothesis ..... 292

analysing data

integral ..... 387

model ..... 391

tangent ..... 388

analysis options

removing ..... 391

angle bisector construction ..... 179, 231

angles  
measuring ..... 172, 224

animating  
points ..... 182, 238

animations

changing points direction ..... 183, 239

pausing ..... 182, 239

resetting ..... 183, 239

resuming ..... 182, 239

answer

using last answer ..... 108

appearance

of 3D graph ..... 193

application

tools menu ..... 2

applications

adding ..... 40

Calculator ..... 74

Data & Statistics ..... 295

deleting ..... 44

Geometry ..... 199

Graphs & Geometry ..... 111

grouping ..... 43

images ..... 67

Lists & Spreadsheet ..... 244

Notes ..... 340

swapping ..... 41

approximate or exact results ..... 257

arcs, drawing ..... 157, 209

area, bounded ..... 146

area, measuring ..... 171, 223

arithmetic calculations ..... 187, 241

aspect ratio, changing in 3D

graphing ..... 195

attributes

changing for objects ..... 168, 220

automatic

sliders in Graphs application ... 105

Automatically creating variables in

Lists & Spreadsheet ..... 101

axes

adjusting ..... 327

changing attributes in Graphing

view ..... 142

dilating ..... 322

moving (translation) ..... 322

scaling ..... 322

setting values (Data & Statistics) 327

axis ranges		
setting in graphs	400	
<b>B</b>		
backup		
of class data	433	
bar charts		
creating	312-313, 315	
bisect a segment	177, 229	
bisecting an angle	179, 231	
bounded area	146	
box plots	302	
breaking long calculations	348	
<b>C</b>		
Calculate output option	274	
calculating distributions (Lists & Spreadsheet)	280	
calculations		
arithmetic	187, 241	
breaking	348	
derivative settings	410	
types available	277	
Calculator		
menus	74	
Calculator application	74	
Calculator history		
copying	94-95	
deleting	96	
reusing	95	
viewing	93	
captions, viewing variable names	296	
capture page option	59	
Capture Selected Handheld option	60	
capturing		
active pages in documents	59	
data (Lists & Spreadsheet)	269	
handheld current screens	59	
images in hand-held mode	59	
pages in active documents	59	
capturing images		
DragScreen	64	
caseplots (default)	296	
Catalogue		
converting measurement units	82	
inserting items from	76, 79, 252, 274	
cell references		
absolute and relative	251	
using in formulas	252	
cells		
body	247	
copying in tables	253	
deleting contents	252	
entering text	248	
exact or approximate results	257	
formulas	247	
inserting ranges in formulas	248	
linking to a variable	102	
linking to variables	254	
navigating in tables	250	
repeating formulas	253	
selecting a block of	253	
selecting a range	248	
sharing table cells	254	
changing		
General Settings	20	
Graphs & Geometry settings	22	
language	1, 3	
Changing language	3	
changing screen size	426	
character strings		
storing as variables	98	
charts		
bar	312	
dot	311	
pie	314	
scatter	299	
chemical equation boxes	353	
circle arcs, creating	157, 209	
circles, drawing	158, 210	
class data		
backup	433	
closing documents (.tns)	34	
collected data		
deleting	384	
viewing details	385	
collecting and managing data sets	382	
colors		
changing	168, 193, 220	
colour		
setting grid colour in Graphs	141	
colours		
3D graph background	194	
applying to backgrounds	343	
changing	251, 333-334, 343	
changing for points	406	
colours, adding	36	

columns	
based on other columns .....	260
copying .....	256
defining options .....	394
deleting .....	256
deleting data from .....	258
generating data in tables .....	259
inserting .....	79, 256
linking to list variables .....	246
moving .....	257
resizing .....	255
selecting .....	255, 406
sharing table columns as lists ..	245
commands	
cSimult( .....	447
inSolve( .....	447
sumult( .....	447
comments	
inserting in Notes .....	345
comparing	
data sets .....	383
comparing collected data sets .....	382
compass construction .....	181, 233
confidence intervals available .....	286
conic analysis .....	446
conic by five points .....	162, 214
conic templates .....	446
conics, graphing .....	123
connected handhelds	
opening documents .....	25
saving files .....	25
constructions	
angle bisector .....	179, 231
compass .....	181, 233
locus .....	167, 180, 219, 232
midpoint .....	177, 229
parallel line .....	178, 230
perpendicular bisector .....	179, 231
perpendicular line .....	178, 230
Content Explorer .....	17
context menu	
graphing from .....	352
context menu in Lists & Spreadsheet	256
converting	
measurement units .....	82
page size; page size, converting;	
preview, setting	
document; setting	
document preview	36
copying	
Calculator history .....	94-95
cells from Excel® spreadsheets ..	268
handheld images .....	59
images .....	59
images in hand-held mode .....	59
screens .....	64
table cells .....	253
table data .....	266
table rows or columns .....	256
copyrights	
adding to documents (.tns) .....	47
creating	
bar charts .....	312-313, 315
histograms .....	306
lists from table columns .....	245
matrices .....	78
new documents .....	442
pie charts .....	314
plots .....	301
probability plots .....	308
scatter plots .....	309
shapes with MathDraw .....	163, 215
summary plots .....	265
system of equations .....	81
user-defined units .....	83
variables .....	97
Creating a new lesson bundle .....	49
Creating a variable from a Graphs &	
Geometry value .....	99
Creating a variable from a Lists &	
Spreadsheet cell value .....	101
creating documents (.tns) .....	31
curve fit options .....	390
curves, bounded area .....	146
customising	
Graphs work area .....	141
<b>D</b>	
data	
backup of class data .....	433
capturing (Lists & Spreadsheet)	269
capturing object data (Graphs &	
Geometry) .....	269
copying to other applications ..	266
deleting from columns .....	258
displaying values .....	298, 301
exact or approximate results ...	257

generating columns of .....	259	derivative settings	
graphing table data .....	262	adjusting .....	410
raw and summary overview .....	300	diagnostics, regression .....	296
retrieving remote .....	380	differential equation graphing .....	446
selecting ranges .....	404	differential equations, graphing .....	133
sorting in tables .....	258	dilating axes .....	322
sorting plotted categories .....	319	disabling functions	
Data & Statistics		"isPrime" .....	446
getting started with .....	295	3D graphing .....	446
images .....	67	conic analysis .....	446
settings .....	296	conic templates .....	446
data analysis		differential equation graphing .....	446
interpolation .....	388	function and conic grab and	
data collections		move .....	445
remote sensors .....	378	geometry functions .....	445
scaling graphs .....	403	implicit graphing .....	446
setting sensor parameters .....	369	inequality graphing .....	446
thresholds .....	380	logbx template .....	447
data plots		numeric solver .....	447
finding curve fit .....	389	polynomial root finder .....	447
data sets		simultaneous equation solver .....	447
comparing .....	383	sliders .....	447
deleting collected .....	384	summation functions and	
renaming .....	384	templates .....	447
selecting for replays .....	409	trigonometric functions .....	446
selecting to plot .....	401	vector functions .....	445
storing .....	382	displaying	
data sets, collecting and managing .....	382	data values .....	298, 301
data types		Graph 1 .....	393
variables .....	97	graphs .....	393
defined functions, recalling .....	91	graphs in Page Layout view .....	394
defining		grid in Graphs .....	141
functions .....	80, 87-88	TI-SmartView™ emulator in	
settings .....	1, 3	teacher software .....	425
units .....	83	two graphs simultaneously .....	393
deleting		distribution, calculating .....	280
applications .....	44	documents .....	442
Calculator history .....	96	documents (.tns)	
collected data sets .....	384	changing General Settings .....	20
contents of table cells .....	252	closing .....	34
data from columns .....	258	creating .....	31
documents (.tns) .....	34	deleting .....	34
elements from lists .....	247	opening .....	32
pages .....	43, 45	opening with TI-SmartView™	
part of an expression .....	92	emulator .....	429
problems .....	43, 45	printing .....	46
table rows and columns .....	256	properties .....	47
variables .....	109	protecting .....	48
deleting images .....	69	read-only .....	48









linking		measurement units	
columns to symbol table .....	394	changing (Vernier DataQuest™)	370
table cell to a variable .....	102	measurements	
table cells to variables .....	254	storing as variables .....	98
table columns to lists .....	246	measurements, converting units ....	82
values .....	97	measuring	
linking variables .....	102	angles .....	172, 224
links		circumference or perimeter ....	170, 222
removing linked variables .....	109	distance between objects .....	169, 221
list maths in Lists & Spreadsheet ....	248	length .....	169, 221
lists		sides of objects .....	170, 222
deleting elements in tables .....	247	slope of object .....	171, 223
inserting elements in tables .....	247	measuring objects .....	169, 221
sharing table columns as .....	245	menus	
storing as variables .....	98	Calculator .....	74
viewing and editing .....	246	midpoint construction .....	177, 229
Lists & Spreadsheet		models, PDF distribution .....	280
variables .....	101-102	motion match	
Lists & Spreadsheet application .....	244	options .....	412
locating software updates .....	433	removing plots .....	412
locking		moving	
intercept of movable lines at		points (Data & Statistics) .....	319
zero .....	324	rows and columns (Lists &	
locus construction .....	167, 180, 219, 232	Spreadsheet) .....	257
log <sub>b</sub> x (convert to log <sub>base</sub> ) .....	447	moving images .....	68
log <sub>b</sub> x template .....	447	multiple-line functions .....	87-88
losing software focus .....	443	multiple cells, selecting .....	253
Lotka-Volterra equations .....	133	multiple statements on entry line ..	82

## M

managing collected data sets .....	382
Managing lesson bundles .....	54
math expression boxes	
attributes .....	355
math expressions	
editing .....	91
selecting in Calculator .....	91
MathDraw, creating shapes with	
gestures .....	163, 215
maths actions .....	349
maths expression boxes .....	349, 354
maths expressions, See expressions	75
maths templates .....	76
matrices	
creating .....	78
inserting rows or columns .....	79
storing as variables .....	98

## N

naming	
table columns .....	245
variables (name conflicts) .....	255
naming columns .....	394
navigating in tables .....	250
new documents .....	442
normal probability, creating plots ..	308
Notes	
adding shapes .....	345
formatting text .....	342
images .....	67
inserting comments .....	345
selecting text .....	342
using colours .....	343
numeric plots, splitting by categories	316
numeric solver .....	447

<b>O</b>	
objects	
changing attributes	168, 220
changing fill colors	168, 220
dilating	176, 228
duplicating	175, 227
enlarging	176, 228
finding area	171, 223
hiding in Geometry	236
measuring	169, 221
reflecting	174, 226
rotating	176, 228
symmetrical images	174, 226
tracing geometric	234
transformation of	174, 226
opening	
lesson bundles	52
Opening a lesson bundle	52
opening documents	
connected handhelds	25
opening documents (.tns)	32
Opening files within a lesson bundle	52
options	
capture page	59
Capture Selected Handheld	60
orthogonal 3D view	194
orthographic 3D projection	194
OS update	
installing on a handheld	27
<b>P</b>	
Page Layout view	394
Page Sorter	14, 41
pages	
adding	44
deleting	43, 45
grouping	43
rearranging	42
selecting	42
ungrouping	44
parabola	
creating from focus and directrix	161, 213
creating from focus and vertex	161, 213
parallel line construction	178, 230
parametric equations	
graphing	129
pasting	
handheld images	59
images	59
images in hand-held mode	59
screens	64
table data	266
PDF	
save document as	46
perpendicular bisector construction	179, 231
perpendicular line construction	178, 230
perspective 3D view	194
pie charts, creating	314
piecewise functions	80
playbacks	
adjusting rate	410
pausing	409
repeating	410
starting	409
plots	
adding a value on existing plot	320
adding movable lines	323
caseplots (default)	296
changing type	321
colors in 3D graphs	193
creating	301
customising	132
dot plots	301
graphing	130-131
path plot	115
predictive	411
probability	308
removing motion match	412
scatter	309
sorting categories	319
summary	264
X-Y line	310
plotting	
dot charts	311
models	391
path plot	115
statistical data	274
table data	262
points	
animating	182, 238
changing colours	406
changing direction	183, 239
creating	152-153, 204-205
identifying intersections	154, 206
labeling coordinates	185
moving (Data & Statistics)	319
of interest	119

selecting (Data & Statistics) . . . .	319
setting markers . . . . .	406
setting options . . . . .	405
points and lines, creating . . . . .	152, 204
polar equations	
graphing . . . . .	129
polygons, drawing . . . . .	159, 211
polynomial root finder . . . . .	447
pooled variances . . . . .	292
pre-defined measurement units . . . .	82
precision of results . . . . .	75
predictive plots	
drawing and clearing . . . . .	411
preview, printed document . . . . .	47
print preview . . . . .	47
printing documents (.tns) . . . . .	46
probability, creating plots . . . . .	308
problems	
adding . . . . .	44
deleting . . . . .	43, 45
renaming . . . . .	46
product improvements . . . . .	435
programmes	
defining . . . . .	87
Proof template . . . . .	341
protecting documents (.tns) . . . . .	48

## Q

Q & A template . . . . .	341
Question	
images . . . . .	67
navigating the application . . . . .	70
questions	
responding . . . . .	71
Questions - students	
accessing toolbar . . . . .	70
types of . . . . .	70
questions (students)	
checking answers . . . . .	72
toolbar options . . . . .	70
Quick Graph, using . . . . .	262
Quick Poll	
images . . . . .	67
Quick Poll questions	
clearing answers . . . . .	73
responding . . . . .	71
types . . . . .	71

## R

random numbers	
generating in tables . . . . .	260
range of cells, inserting in formulas .	248
raw data . . . . .	300
raw data, adjusting histogram scale	306
rays	
creating . . . . .	155, 207
read-only documents (.tns) . . . . .	48
reducing view details area . . . . .	385
RefreshProbeVars . . . . .	385
registering products . . . . .	432
regression diagnostics . . . . .	296
regression lines, showing . . . . .	325
relations	
displaying history . . . . .	138, 192
graphing . . . . .	126
showing table of values . . . . .	136
remote data	
retrieving . . . . .	380
removing	
variables . . . . .	109
removing images . . . . .	69
renaming	
data sets . . . . .	384
functions . . . . .	138
renaming problems . . . . .	46
replays	
starting . . . . .	409
rescaling	
graphs (dilation) . . . . .	322
graphs (translation) . . . . .	322
resizing	
table rows and columns . . . . .	255
resizing images . . . . .	69
restoring data . . . . .	408
results	
copying from Calculator history . .	94-95
setting decimal approximation . .	75
using last answer . . . . .	108
reusing	
last answer in Calculator . . . . .	108
reviewing	
restrictions . . . . .	441
rotating objects . . . . .	176, 228
rows	
copying . . . . .	256
deleting . . . . .	256

inserting .....	79, 256	for computers .....	366
moving .....	257	for handhelds .....	365
resizing .....	255	for remote data collections .....	378
selecting .....	255	interfaces .....	364
<b>S</b>			
Save		LED lights .....	380
document as PDF .....	46	reversing reading display .....	371
saving		setting to zero .....	371
captured images .....	59	setting up offline .....	369
captured pages .....	62	triggering .....	380
documents (.tns) in emulator .....	429	types .....	365
handheld screens .....	62	sequences, generating in table	
images .....	59	columns .....	261
saving documents (.tns) .....	33-34	sets	
saving files		renaming data sets .....	384
to connected handhelds .....	25	sets of data, comparing .....	383
scaling graphs .....	402	sets, storing data as .....	382
scaling Plane Geometry Analytic		settings	
window .....	139	Data & Statistics application .....	296
scatter plots .....	309	defining .....	1, 3
screen capture tool .....	59	in Geometry application .....	112, 199
screen captures		language .....	1, 3
copying .....	64	TI-SmartView™ emulator .....	427
pasting .....	64	shapes	
scrolling in tables .....	250	adding in Notes .....	345
segment		creating with MathDraw .....	163, 215
bisector .....	177, 229	drawing geometric .....	157, 209
segments		equations of .....	186
creating .....	155, 207	legends .....	299
selecting		showing	
a block of table cells .....	253	3D graphs .....	194
columns .....	406	functions in work areas .....	144
data ranges .....	404	showing format toolbar .....	35
data sets for replays .....	409	showing screen details .....	407
data sets to plot .....	401	simultaneous equation solver .....	447
expressions in Calculator .....	91	sliders	
table rows or columns .....	255	animating 3D graphs .....	197
templates .....	341	sliders, adjusting variable values .....	105
text in Notes .....	342	slope .....	388
selecting images .....	68	measuring .....	171, 223
selecting pages .....	42	software	
Sending Lesson Bundles to		checking for updates .....	433
connected handhelds .....	57	installing updates .....	433
sensors		software licences, activating .....	430
calibrating .....	371	software version number .....	434
changing measurement units .....	370	solving simple maths expressions .....	75
connecting .....	368	sorting	
		plotted categories .....	319
		table data .....	258
		splitting numeric plots by categories .....	316

spreadsheets		
navigating	250	
sharing columns as lists	245	
statistical tests, supported	288	
statistics, drawing plots	338	
status bar	3	
stored variables		
linking to	102	
storing		
data as sets	382	
striking data	408	
strings		
storing as variables	98	
strip charts	372	
substituting a value for a variable	109	
summary data	300	
summary information, displaying	298	
summary plots	262, 264	
creating	265	
summation functions and templates	447	
symbol table		
linking columns to	394	
syntax		
using to prevent naming		
conflicts	255	
system of equations	81	
<b>T</b>		
table data		
graphing	262	
sorting	258	
using in statistical analysis (Lists & Spreadsheet)	274	
table of values	136	
tables		
changing expressions for		
functions	293	
copying rows or columns	256	
deleting contents of cells	252	
deleting list elements	247	
deleting rows and columns	256	
displaying list of functions	293	
editing settings	293	
generating column data	259	
inserting list elements	247	
inserting rows or columns	256	
linking columns to lists	246	
moving rows or columns	257	
navigating in	250	
restoring data	408	
selecting rows or columns	255	
sharing columns as lists	245	
showing function values	292	
striking data	408	
working with cells	251	
tangents, creating	156, 208	
templates		
maths	76-77	
Notes	341	
Proof	341	
Q & A	341	
selecting	341	
Test Code Examples	439	
Test Mode folder	442	
Test Mode restrictions	441, 444	
text		
adding to work areas	113, 141, 201, 237	
changing colours	343	
entering	248	
formatting in Notes	342	
selecting in Notes	342	
text formatting	35	
threshold values		
increasing/decreasing	380	
TI-Nspire™ applications		
images	67	
TI-Nspire™ Screen Capture Window	61	
zooming in/out	62	
TI-Nspire™ SmartView Emulator		
capturing images	59, 64	
TI-SmartView™		
capturing images	59	
DragScreen feature	59	
TI-SmartView™ emulator	15, 426	
capturing screens	429	
changing panel width	425-426	
opening	424	
opening documents (.tns)	429	
options	428	
saving documents (.tns)	429	
settings	427	
TI-SmartView™ Emulator	424	
TI websites	432	
titles, clicking to see variable names		
(Data & Statistics)	296	
tool palette	2	





## Z

zooming .....	139
handheld preview .....	36
in .....	404
in/out .....	62
out .....	404